

THE SELKIRKS AND MONASHEES AT MACKENZIE VILLAGE

FIRST AMENDMENT TO DISCLOSURE STATEMENT

REAL ESTATE DEVELOPMENT MARKETING ACT OF BRITISH COLUMBIA

August 30, 2023

This amendment to disclosure statement (the “**Amendment**”) amends a disclosure statement dated December 19, 2022 (the “**Disclosure Statement**”). The Disclosure Statement, as amended by this Amendment, relates to an offering by 0929468 B.C. Ltd. (the “**Developer**”) for the sale of proposed residential and commercial strata lots in phase 1 of a proposed 2 phase strata development known as “The Selkirks and Monashees at Mackenzie Village” (the “**Development**”) to be constructed on certain lands and premises located at 1701 Nichol Road, Revelstoke, B.C., V0E 2S3.

DEVELOPER

Name: 0929468 B.C. Ltd.
Business Address and Address for Service: Suite 900 - 900 West Hastings Street, Vancouver, B.C., V6E 1M3

BROKERAGE OF DEVELOPER

The Developer intends to market the Strata Lots (as defined in section 2.1 of the Disclosure Statement) itself. Any employees of the Developer who market the Strata Lots on behalf of the Developer may not be licensed under the *Real Estate Services Act* (British Columbia) and are not acting on behalf of purchasers. In addition to marketing the Strata Lots itself, the Developer may also utilize the services of licensed realtors. Should the Developer utilize the services of licensed realtors, the Developer reserves the right to appoint agents from time to time or to change its agent.

The Disclosure Statement, as amended by this Amendment, relates to a development property that is not yet completed. Please refer to section 7.2 of the Disclosure Statement, as amended by this Amendment, for information on the Purchase Agreement. That information has been drawn to the attention of _____ who has confirmed that fact by initialling the space provided here _____.

DISCLAIMER

THE DISCLOSURE STATEMENT, AS AMENDED BY THIS AMENDMENT, HAS BEEN FILED WITH THE SUPERINTENDENT OF REAL ESTATE, BUT NEITHER THE SUPERINTENDENT OF REAL ESTATE, NOR ANY OTHER AUTHORITY OF THE GOVERNMENT OF THE PROVINCE OF BRITISH COLUMBIA, HAS DETERMINED THE MERITS OF ANY STATEMENT CONTAINED IN THE DISCLOSURE STATEMENT, AS AMENDED BY THIS AMENDMENT, OR WHETHER THE DISCLOSURE STATEMENT, AS AMENDED BY THIS AMENDMENT, CONTAINS A MISREPRESENTATION OR OTHERWISE FAILS TO COMPLY WITH THE REQUIREMENTS OF THE *REAL ESTATE DEVELOPMENT MARKETING ACT* (BRITISH COLUMBIA). IT IS THE RESPONSIBILITY OF THE DEVELOPER TO DISCLOSE PLAINLY ALL MATERIAL FACTS, WITHOUT MISREPRESENTATION.

AMENDMENT TO DISCLOSURE STATEMENT

The Disclosure Statement is hereby amended as follows:

1. by deleting paragraph 1.2(b)(ii) in its entirety and replacing it with the following:

“(ii) any remaining strata lots in the Mackenzie Plaza Development (as defined in section 2.1(f)). For greater certainty, the Developer has completed the sale of certain strata lots in the Mackenzie Plaza Development, and may complete the sale of some or all of the remaining strata lots in the Mackenzie Plaza Development following the date hereof and/or may retain certain of such strata lots.”;

2. by deleting from the second paragraph of paragraph 2.1(b)(i) the words “198 residential strata lots” and replacing them with the words “204 residential strata lots”;

3. by deleting the table under the third paragraph of paragraph 2.1(b)(i) and replacing it with the following table:

<u>“Phase</u>	<u>Number of Strata Lots</u>	<u>Number of Buildings</u>
Phase 1	102	3
Phase 2	102	3”;

4. by deleting paragraph 2.1(b)(ii) in its entirety and replacing it with the following:

“(ii) Strata Lots

The Strata Lots in Phase 1 are currently intended to consist of the following types:

<u>Type of Strata Lots</u>	<u>Building 1</u>	<u>Building 2</u>	<u>Building 3</u>
1 Bedroom	2	6	2
2 Bedroom	8	17	11
2 Bedroom + Den	0	0	0
3 Bedroom	18	13	19
3 Bedroom + Den	0	1	1
4 Bedroom	1	1	2
TOTAL	29	38	35”;

5. by deleting paragraph 2.1(f)(ii) in its entirety and replacing it with the following:

“(ii) Mackenzie Plaza Development Lands: The second development within the Project (the “**Mackenzie Plaza Development**”) was developed on the lands formerly legally described as Parcel Identifier: 031-465-421, Lot A Section 23 Township 23 Range 2 West of the 6th Meridian Kootenay District Plan EPP98511 (the “**Mackenzie Plaza Development Lands**”). The Mackenzie Plaza

Development consists of commercial and residential strata lots constructed over two phases. The construction of the Mackenzie Plaza Development was completed in 2023, and the Mackenzie Plaza Development Lands have been stratified by Strata Plan EPS8686.”;

6. by deleting the table under the second paragraph of section 2.3 and replacing it with the following table:

<u>Phase</u>	<u>Number of Strata Lots</u>
Phase 1	102
Phase 2	102
Total	204”;

7. by deleting the fifth paragraph of section 2.3 in its entirety (being, for greater certainty, the paragraph that begins with the words “A copy of the proposed Form P...” and replacing it with the following:

“The Developer previously prepared a Form P (the “**Original Form P**”) that was attached as Exhibit B to the original disclosure statement dated December 19, 2022 for the Development. The Original Form P was not approved or signed by the Approving Officer. The Developer subsequently made certain changes to the Form P for the Development to reflect, among other things, changes to the number of strata lots in the Development. This Disclosure Statement was amended to include the updated Form P (the “**Revised Form P**”) by the first amendment to this Disclosure Statement. Copies of the Original Form P and the Revised Form P are attached to this Disclosure Statement as Exhibit B. The Approving Officer has not yet approved the phasing for the Development. The Approving Officer has not yet approved the Revised Form P, and has not indicated whether or not the Approving Officer is prepared to sign the Revised Form P in due course. Accordingly, the Revised Form P is subject to any changes required by the Approving Officer.”;

8. by deleting from the first paragraph of subsection 3.6(e) the words “approximately 198 storage lockers” and replacing them with the words “approximately 204 storage lockers”;
9. by deleting from section 4.1(d) the words “Strata Lots 1 to 99” and replacing them with the words “Strata Lots 1 to 102”;
10. by amending subsection 4.3(b) as follows:

- (a) by deleting paragraph 4.3(b)(xiii) in its entirety and replacing it with the following:

“(xiii) Intentionally deleted.”;

- (b) by deleting paragraph 4.3(b)(xiv) in its entirety and replacing it with the following:

“(xiv) Intentionally deleted.”;

- (c) by deleting paragraph 4.3(b)(xv) in its entirety and replacing it with the following:

“(xv) Intentionally deleted.”;

- (d) by deleting paragraph 4.3(b)(xvii) in its entirety and replacing it with the following:
“(xvii) Intentionally deleted.”;
 - (e) by deleting paragraph 4.3(b)(xix) in its entirety and replacing it with the following:
“(xix) Intentionally deleted.”;
 - (f) by deleting paragraph 4.3(b)(xx) in its entirety and replacing it with the following:
“(xx) Intentionally deleted.”; and
 - (g) by deleting paragraph 4.3(b)(xxii) in its entirety and replacing it with the following:
“(xxii) Priority Agreement CB385876 and Priority Agreement CB385879 –These encumbrances are priority agreements granting Statutory Right of Way CB385874 and Covenant CB385877 priority over Mortgage CA9488891 and Assignment of Rents CA9488892.”;
11. by amending subsection 4.3(c) as follows:
- (a) by deleting paragraph 4.3(c)(i) in its entirety and replacing it with the following:
“(i) Intentionally deleted.”; and
 - (b) by deleting paragraph 4.3(c)(iv) in its entirety and replacing it with the following:
“(iv) Intentionally deleted.”;
12. by deleting the table under the first paragraph of subsection 5.1(a) and replacing it with the following:
- | <u>“Building Number</u> | <u>Estimated Date Range for Commencement of Construction</u> |
|-------------------------|--|
| Building 1 | September 1, 2023 to December 1, 2023 |
| Building 2 | September 1, 2023 to December 1, 2023 |
| Building 3 | September 1, 2023 to December 1, 2023”; |
13. by deleting subsection 7.2(p) in its entirety and replacing it with the following:
“(p) Intentionally deleted.”;
14. by deleting from the page titled “EXHIBITS TO THIS DISCLOSURE STATEMENT” the words “Exhibit M - Canadian Purchaser Confirmation Addendum to Purchase Agreement” and replacing them with the words “Exhibit M - Intentionally Deleted”;
15. by deleting Exhibit A-1 to the Disclosure Statement and replacing it with Exhibit A-1 attached hereto;

16. by deleting Exhibit B to the Disclosure Statement and replacing it with Exhibit B attached hereto;
17. by deleting Exhibit C-1 to the Disclosure Statement and replacing it with Exhibit C-1 attached hereto;
18. by deleting Exhibit E-1 to the Disclosure Statement and replacing it with Exhibit E-1 attached hereto;
19. by deleting Exhibit F to the Disclosure Statement and replacing it with Exhibit F attached hereto;
20. by deleting Exhibit G-1 to the Disclosure Statement and replacing it with Exhibit G-1 attached hereto;
21. by deleting Exhibit H to the Disclosure Statement and replacing it with Exhibit H attached hereto;
22. by deleting Exhibit I to the Disclosure Statement and replacing it with Exhibit I attached hereto; and
23. by deleting Exhibit M to the Disclosure Statement and replacing it with Exhibit M attached hereto.

DEEMED RELIANCE

Section 22 of the *Real Estate Development Marketing Act* (British Columbia) provides that every purchaser who is entitled to receive the Disclosure Statement, as amended by this Amendment, is deemed to have relied on any false or misleading statement of a material fact contained in the Disclosure Statement, as amended by this Amendment, if any, and any omission to state a material fact. The Developer, its directors and any person who has signed or authorized the filing of the Disclosure Statement, as amended by this Amendment, are liable to compensate the purchaser for any misrepresentation, subject to any defences available under section 22 of the *Real Estate Development Marketing Act* (British Columbia).

DECLARATION

The foregoing statements disclose, without misrepresentation, all material facts relating to the Development referred to above, as required by the *Real Estate Development Marketing Act* (British Columbia), as of the 30th day of August, 2023.

DEVELOPER

0929468 B.C. LTD.

By: 

Authorized Signatory

By: _____
Authorized Signatory

DIRECTORS OF 0929468 B.C. LTD.



DAVID EVANS



SHELLEY ANNE EVANS

EXHIBIT A-1
PRELIMINARY PLAN – PHASE 1

See attached.

**PLAN TO ACCOMPANY DISCLOSURE
STATEMENT ON PART OF LOT B
SECTION 23 TOWNSHIP 23 RANGE 2
WEST OF THE 6TH MERIDIAN
KOOTENAY DISTRICT PLAN EPP125979
(Pending Registration)**

Sheet 1 of 19 Sheets

**PRE-STRATA PLAN
PHASE 1**

BCGS 82L.100



The intended plot size of this plan is 432mm in width by 280mm in height (B size) when plotted at a scale of 1:1500.

LEGEND

SL denotes Strata Lot

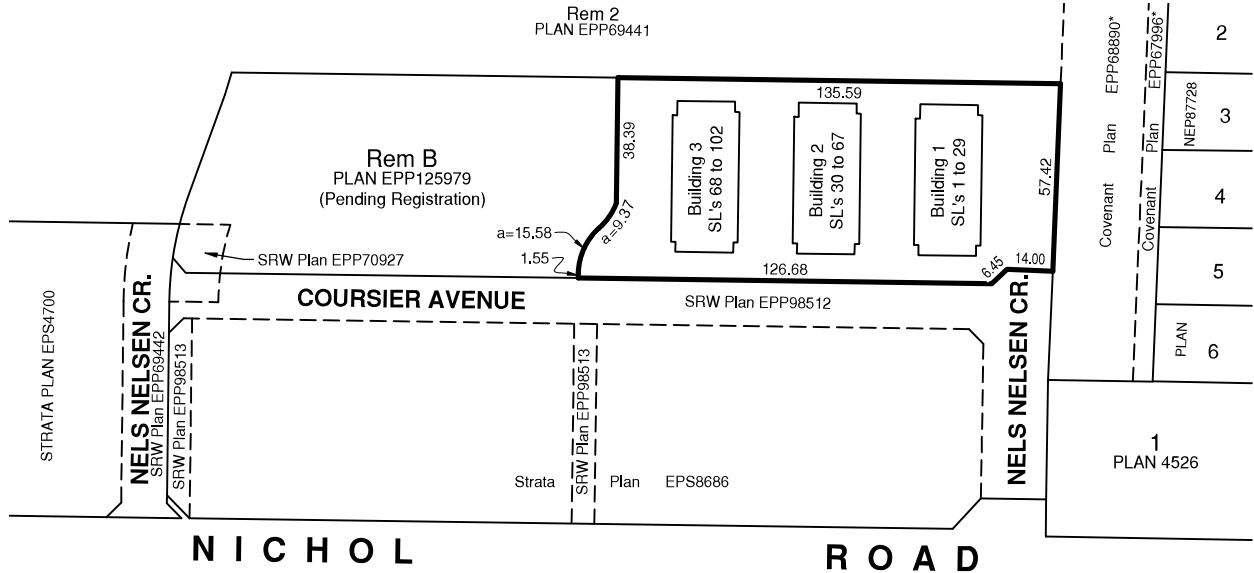

Project Name:
The Selkirks at MacKenzie Village

Civic Address:
Nichol Road, Revelstoke, BC

Architectural plans provided by Stark Architecture on July 16th, 2023.

Strata lot boundaries are defined by the centreline of the structural portion of walls.

Limited Common Property boundaries are approximate and are subject to change upon completion of construction.

All private gardens and balconies are defined as to height by the centre of the floor above, or its extensions or where there is no floor above by the average height of a strata lot within the same building unless otherwise indicated.

This plan lies within the Columbia Shuswap Regional District and the City of Revelstoke

I, Anna Niraz, a British Columbia land surveyor, hereby certify that the information contained within this plan substantially complies with architectural plans for the above noted development.

Dated this 1st day of August, 2023

Anna Niraz Digitally signed by
Anna Niraz VI9T5V
VI9T5V Date: 2023.08.03
16:23:17 -07'00'

Anna Niraz

BCLS 964



202 - 1475 Ellis Street
Kelowna, BC

PROJECT REF./DRAWING No.
22-03760-001-DSC01-R2

Plotted: 8/3/2023 10:40 AM User: KarlaHerrera

PARKADE LEVEL

PRE-STRATA PLAN PHASE 1



The intended plot size of this plan is 432mm in width by 280mm in height (B size) when plotted at a scale of 1:500.



LEGEND

- ⊙ denotes Common Property
- Elec denotes electrical room
- H/C denotes handicapped
- Mech denotes mechanical room
- Vest denotes vestibule

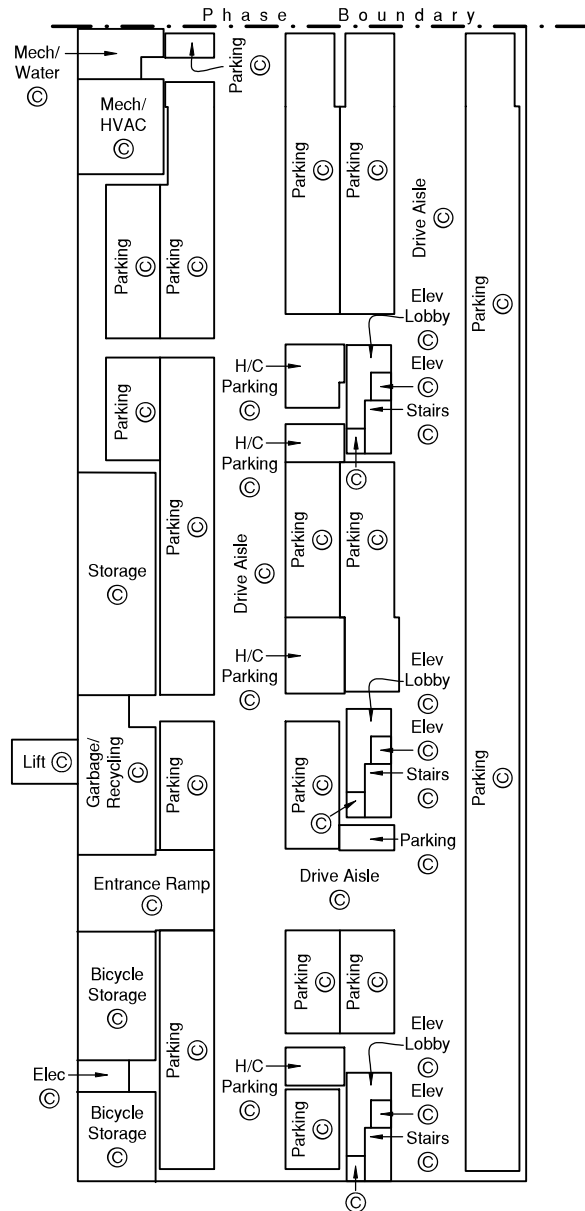

Plotted: 8/3/2023 10:40 AM User: Karla Herrera



202 - 1475 Ellis Street
Kelowna, BC

PROJECT REF./DRAWING No.
22-03760-001-DSC01-R2

BUILDING 1 - LEVEL 1 PART SL'S 1 TO 13 INCLUSIVE

Sheet 3 of 19 Sheets

PRE-STRATA PLAN PHASE 1



The intended plot size of this plan is 432mm in width by 280mm in height (B size) when plotted at a scale of 1:200.

LEGEND

- SL denotes Strata Lot
- ⊙ denotes Common Property
- LCP denotes Limited Common property for the Exclusive Use of Designated Strata Lot
- Mech denotes mechanic room
- Elev denotes elevator
- Vest denotes vestibule

Areas of Limited Common Property (Private Gardens and Balconies) lower/upper vertical extent are defined by the centre of the floor below/above or its extensions, or where there is no floor below/above, by the average height of a strata lot within the same building unless otherwise indicated.

Method of Measurement:

- Midpoint of structural portion of exterior walls
- Midpoint of structural portion of demising walls between strata lots

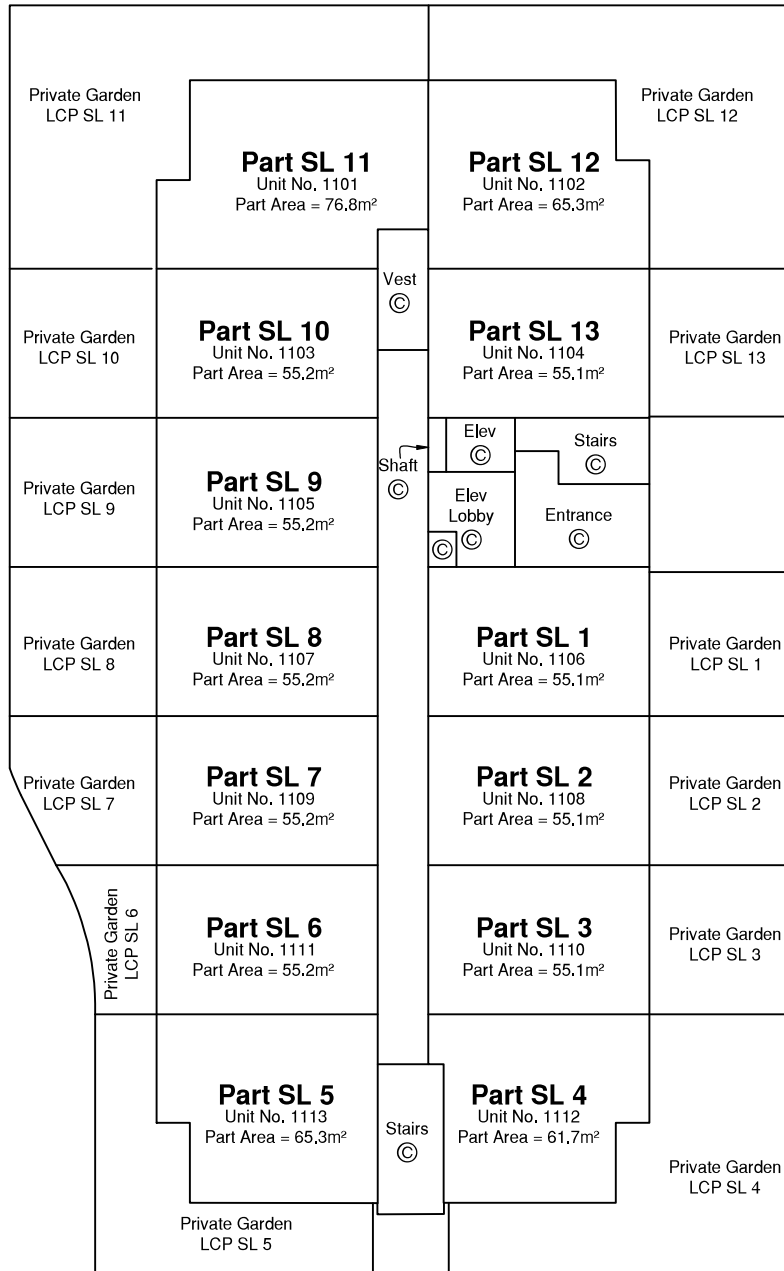

Plotted: 8/3/2023 10:40 AM User: Karla Herrera



202 - 1475 Ellis Street
Kelowna, BC

PROJECT REF./DRAWING No.
22-03760-001-DSC01-R2

Anna Niraz, BCLS 964
August 1st, 2023

BUILDING 1 - LEVEL 2 PART SL'S 1 TO 13 INCLUSIVE

PRE-STRATA PLAN PHASE 1



The intended plot size of this plan is 432mm in width by 280mm in height (B size) when plotted at a scale of 1:200.

LEGEND

- SL denotes Strata Lot
- ⊙ denotes Common Property
- LCP denotes Limited Common property for the Exclusive Use of Designated Strata Lot
- Mech denotes mechanic room
- Elev denotes elevator
- Vest denotes vestibule

Areas of Limited Common Property (Private Gardens and Balconies) lower/upper vertical extent are defined by the centre of the floor below/above or its extensions, or where there is no floor below/above, by the average height of a strata lot within the same building unless otherwise indicated.

Method of Measurement:

- Midpoint of structural portion of exterior walls
- Midpoint of structural portion of demising walls between strata lots

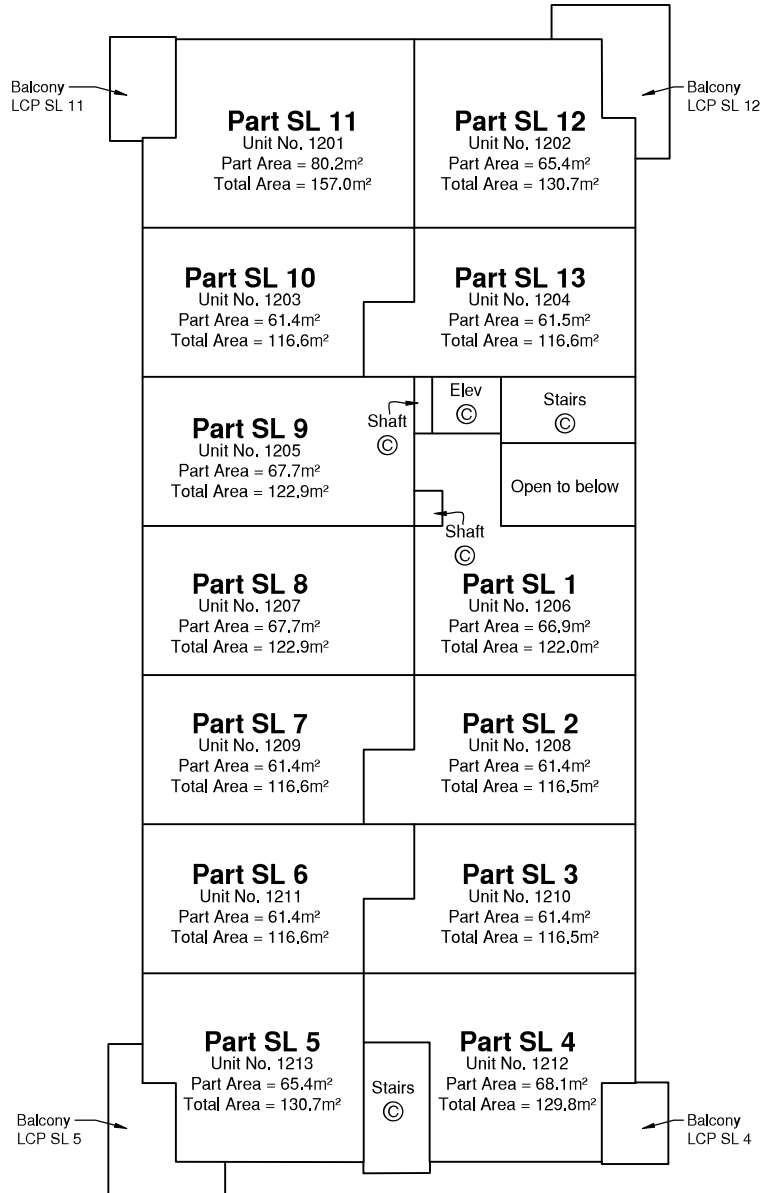

Plotted: 8/3/2023 10:40 AM User: Karla Herrera



202 - 1475 Ellis Street
Kelowna, BC

PROJECT REF./DRAWING No.
22-03760-001-DSC01-R2

BUILDING 1 - LEVEL 3 SL'S 14 TO 21 INCLUSIVE

Sheet 5 of 19 Sheets

PRE-STRATA PLAN PHASE 1



The intended plot size of this plan is 432mm in width by 280mm in height (B size) when plotted at a scale of 1:200.

LEGEND

- SL denotes Strata Lot
- ⊙ denotes Common Property
- LCP denotes Limited Common property for the Exclusive Use of Designated Strata Lot
- Mech denotes mechanic room
- Elev denotes elevator
- Vest denotes vestibule

Areas of Limited Common Property (Private Gardens and Balconies) lower/upper vertical extent are defined by the centre of the floor below/above or its extensions, or where there is no floor below/above, by the average height of a strata lot within the same building unless otherwise indicated.

Method of Measurement:

- Midpoint of structural portion of exterior walls
- Midpoint of structural portion of demising walls between strata lots

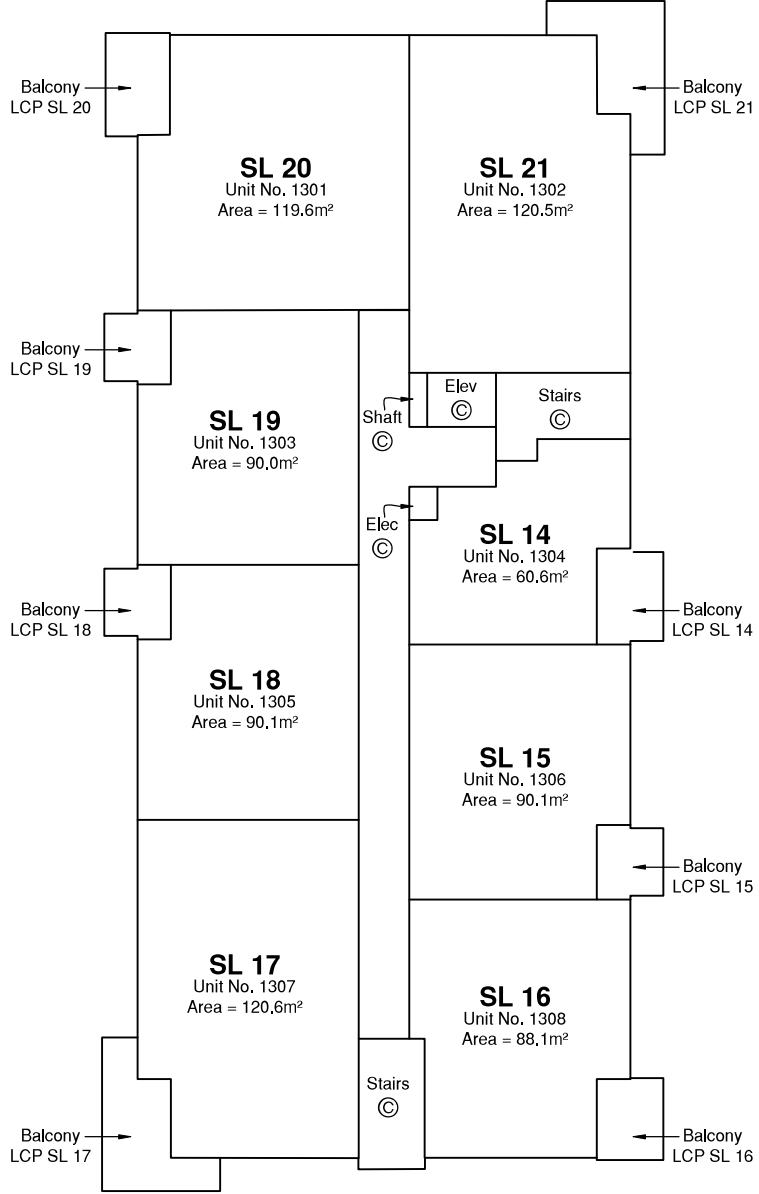

Plotted: 8/3/2023 10:40 AM User: Karla Herrera



202 - 1475 Ellis Street
Kelowna, BC

PROJECT REF./DRAWING No.
22-03760-001-DSC01-R2

Anna Niraz, BCLS 964
August 1st, 2023

BUILDING 1 - LEVEL 4 SL'S 22 TO 29 INCLUSIVE

Sheet 6 of 19 Sheets

PRE-STRATA PLAN PHASE 1



The intended plot size of this plan is 432mm in width by 280mm in height (B size) when plotted at a scale of 1:200.

LEGEND

- SL denotes Strata Lot
- ⊙ denotes Common Property
- LCP denotes Limited Common property for the Exclusive Use of Designated Strata Lot
- Mech denotes mechanic room
- Elev denotes elevator
- Vest denotes vestibule

Areas of Limited Common Property (Private Gardens and Balconies) lower/upper vertical extent are defined by the centre of the floor below/above or its extensions, or where there is no floor below/above, by the average height of a strata lot within the same building unless otherwise indicated.

Method of Measurement:

- Midpoint of structural portion of exterior walls
- Midpoint of structural portion of demising walls between strata lots

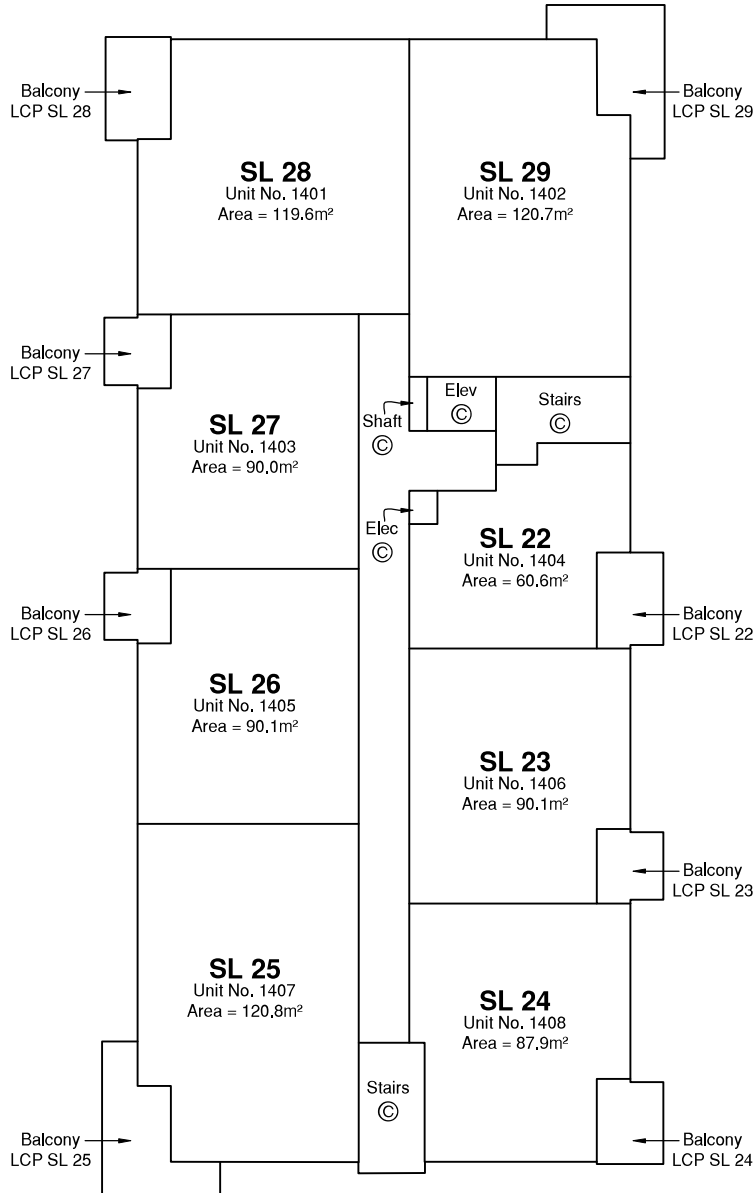

Plotted: 8/3/2023 10:40 AM User: Karla Herrera



202 - 1475 Ellis Street
Kelowna, BC

PROJECT REF./DRAWING No.
22-03760-001-DSC01-R2

Anna Niraz, BCLS 964
August 1st, 2023

BUILDING 1 - ROOF LEVEL

Sheet 7 of 19 Sheets

PRE-STRATA PLAN PHASE 1



The intended plot size of this plan is 432mm in width by 280mm in height (B size) when plotted at a scale of 1:200.

LEGEND

- SL denotes Strata Lot
- ⊙ denotes Common Property
- LCP denotes Limited Common property for the Exclusive Use of Designated Strata Lot
- Mech denotes mechanic room
- Elev denotes elevator
- Vest denotes vestibule

Areas of Limited Common Property (Private Gardens and Balconies) lower/upper vertical extent are defined by the centre of the floor below/above or its extensions, or where there is no floor below/above, by the average height of a strata lot within the same building unless otherwise indicated.

Method of Measurement:

- Midpoint of structural portion of exterior walls
- Midpoint of structural portion of demising walls between strata lots

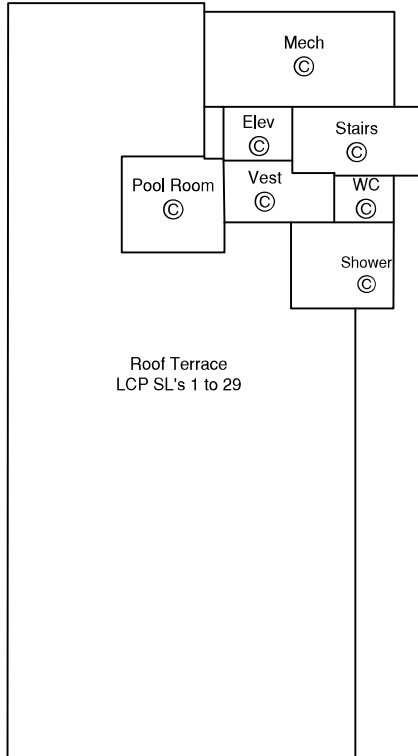

Plotted: 8/3/2023 10:40 AM User: Karla Herrera



202 - 1475 Ellis Street
Kelowna, BC

PROJECT REF./DRAWING No.
22-03760-001-DSC01-R2

Anna Niraz, BCLS 964
August 1st, 2023

BUILDING 2 - LEVEL 1 SL'S 30 TO 37 INCLUSIVE

Sheet 8 of 19 Sheets

PRE-STRATA PLAN PHASE 1



The intended plot size of this plan is 432mm in width by 280mm in height (B size) when plotted at a scale of 1:200.

LEGEND

- SL denotes Strata Lot
- ⊙ denotes Common Property
- LCP denotes Limited Common property for the Exclusive Use of Designated Strata Lot
- Mech denotes mechanic room
- Elev denotes elevator
- Vest denotes vestibule

Areas of Limited Common Property (Private Gardens and Balconies) lower/upper vertical extent are defined by the centre of the floor below/above or its extensions, or where there is no floor below/above, by the average height of a strata lot within the same building unless otherwise indicated.

Method of Measurement:

- Midpoint of structural portion of exterior walls
- Midpoint of structural portion of demising walls between strata lots

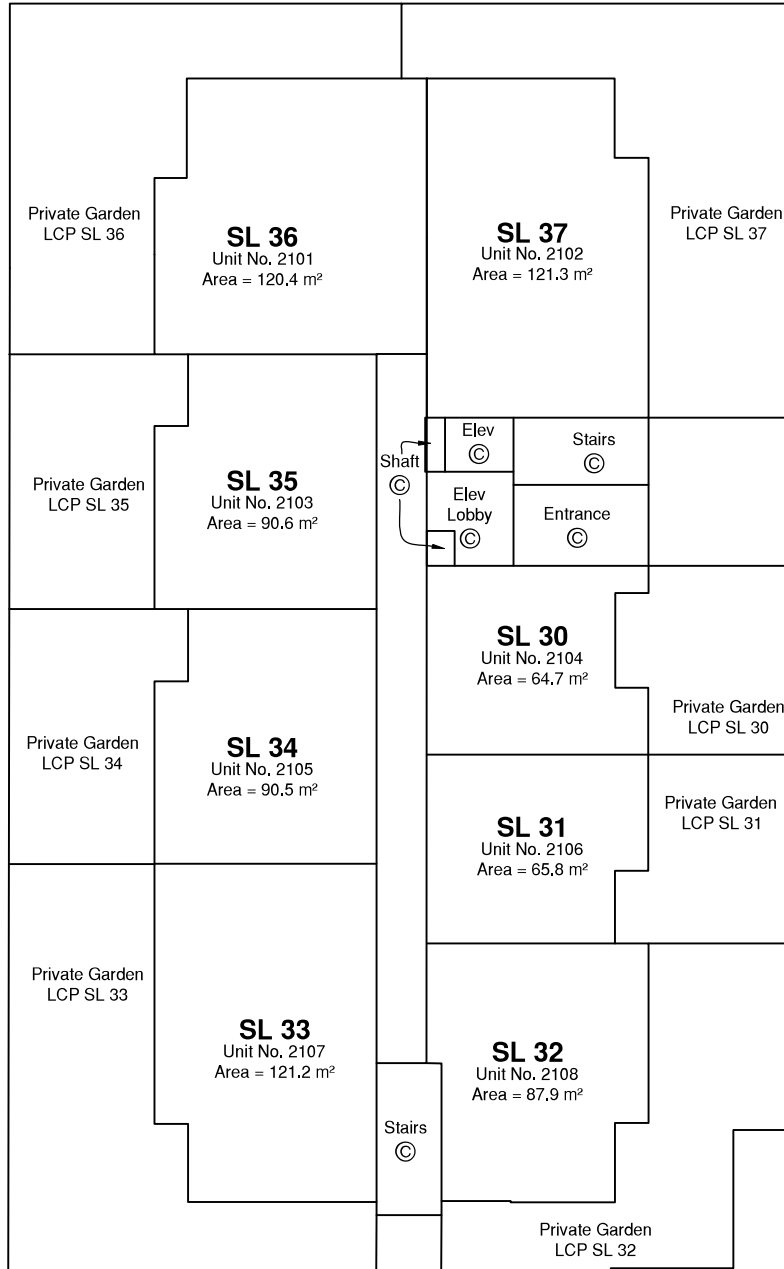

Plotted: 8/3/2023 10:40 AM User: Karla Herrera



202 - 1475 Ellis Street
Kelowna, BC

PROJECT REF./DRAWING No.
22-03760-001-DSC01-R2

Anna Niraz, BCLS 964
August 1st, 2023

BUILDING 2 - LEVEL 2 SL'S 38 TO 45 INCLUSIVE

PRE-STRATA PLAN PHASE 1



The intended plot size of this plan is 432mm in width by 280mm in height (B size) when plotted at a scale of 1:200.

LEGEND

- SL denotes Strata Lot
- ⊙ denotes Common Property
- LCP denotes Limited Common property for the Exclusive Use of Designated Strata Lot
- Mech denotes mechanic room
- Elev denotes elevator
- Vest denotes vestibule

Areas of Limited Common Property (Private Gardens and Balconies) lower/upper vertical extent are defined by the centre of the floor below/above or its extensions, or where there is no floor below/above, by the average height of a strata lot within the same building unless otherwise indicated.

Method of Measurement:

- Midpoint of structural portion of exterior walls
- Midpoint of structural portion of demising walls between strata lots

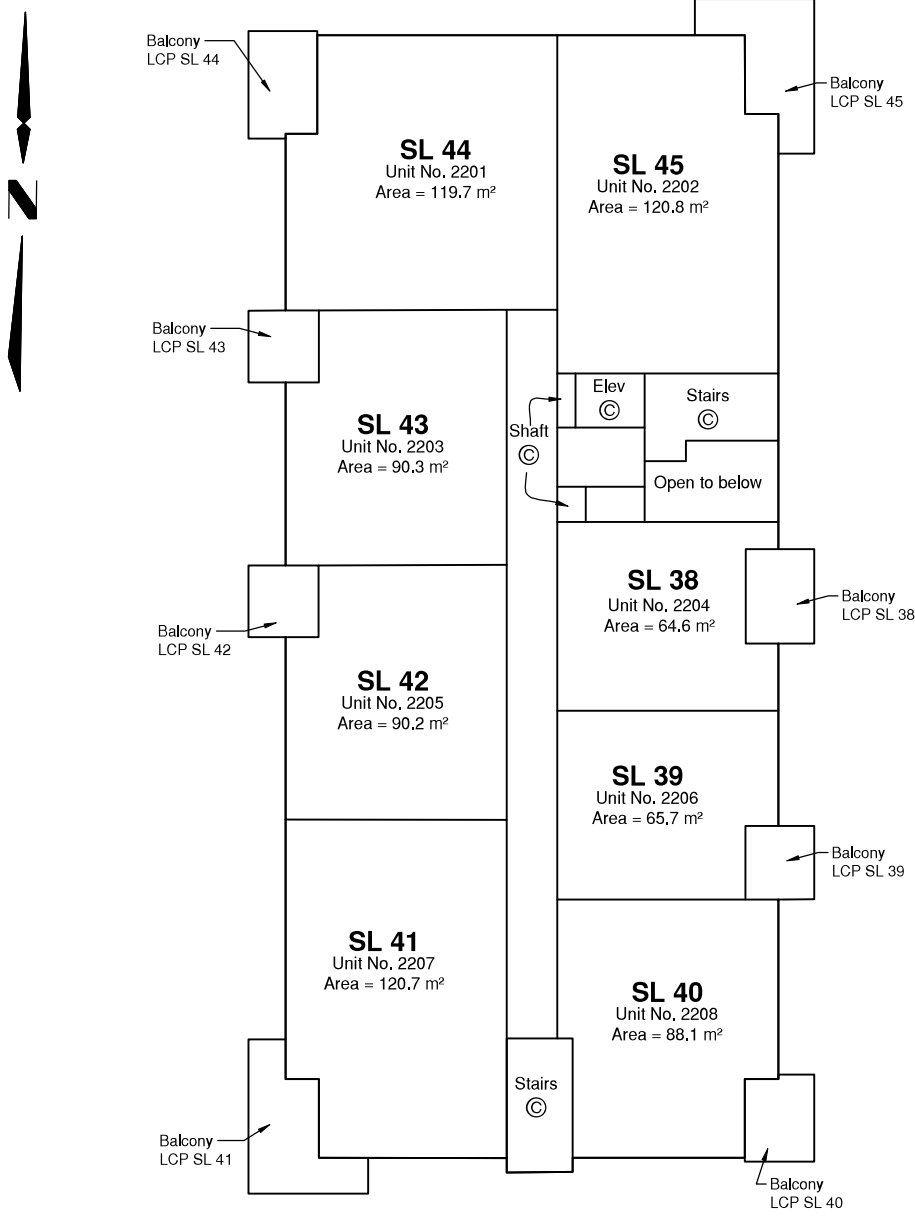

Plotted: 8/3/2023 10:40 AM User: Karla Herrera



202 - 1475 Ellis Street
Kelowna, BC

PROJECT REF./DRAWING No.
22-03760-001-DSC01-R2

BUILDING 2 - LEVEL 3 SL'S 46 TO 53 INCLUSIVE

Sheet 10 of 19 Sheets

PRE-STRATA PLAN PHASE 1



The intended plot size of this plan is 432mm in width by 280mm in height (B size) when plotted at a scale of 1:200.

LEGEND

- SL denotes Strata Lot
- ⊙ denotes Common Property
- LCP denotes Limited Common property for the Exclusive Use of Designated Strata Lot
- Mech denotes mechanic room
- Elev denotes elevator
- Vest denotes vestibule

Areas of Limited Common Property (Private Gardens and Balconies) lower/upper vertical extent are defined by the centre of the floor below/above or its extensions, or where there is no floor below/above, by the average height of a strata lot within the same building unless otherwise indicated.

Method of Measurement:

- Midpoint of structural portion of exterior walls
- Midpoint of structural portion of demising walls between strata lots

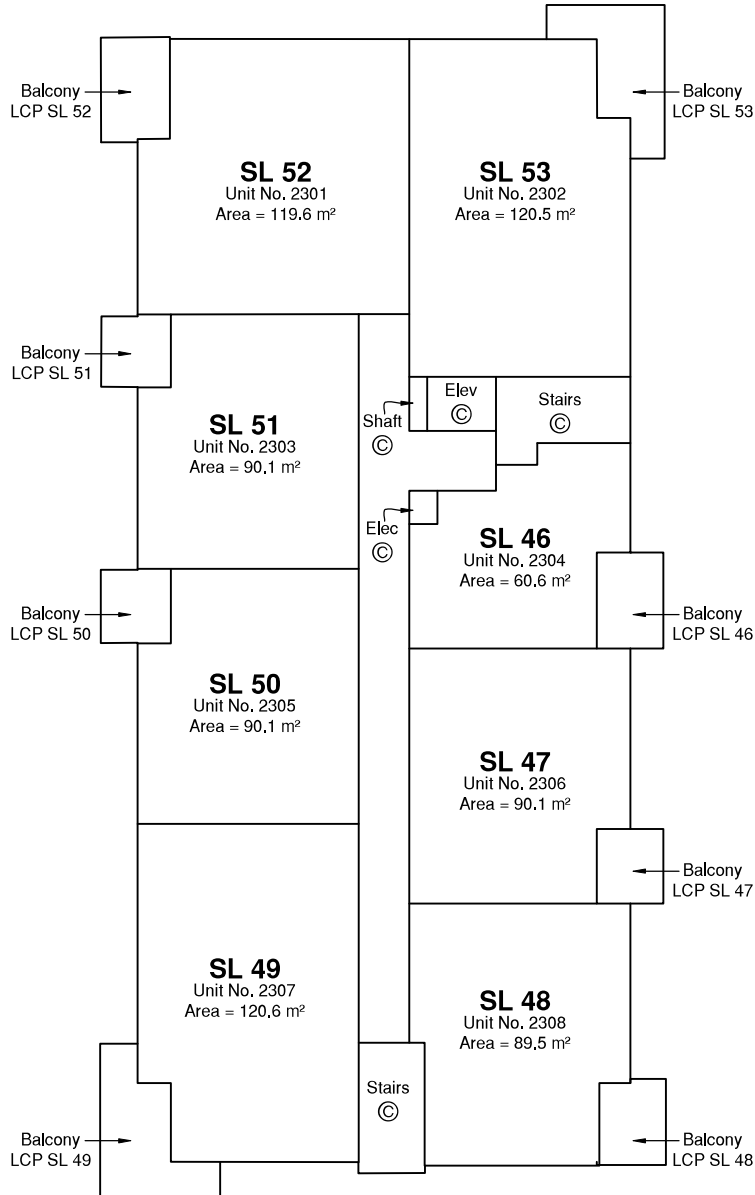

Plotted: 8/3/2023 10:40 AM User: Karla Herrera



202 - 1475 Ellis Street
Kelowna, BC

PROJECT REF./DRAWING No.
22-03760-001-DSC01-R2

BUILDING 2 - LEVEL 4 SL'S 54 TO 61 INCLUSIVE

Sheet 11 of 19 Sheets

PRE-STRATA PLAN PHASE 1



The intended plot size of this plan is 432mm in width by 280mm in height (B size) when plotted at a scale of 1:200.

LEGEND

- SL denotes Strata Lot
- ⊙ denotes Common Property
- LCP denotes Limited Common property for the Exclusive Use of Designated Strata Lot
- Mech denotes mechanic room
- Elev denotes elevator
- Vest denotes vestibule

Areas of Limited Common Property (Private Gardens and Balconies) lower/upper vertical extent are defined by the centre of the floor below/above or its extensions, or where there is no floor below/above, by the average height of a strata lot within the same building unless otherwise indicated.

Method of Measurement:

- Midpoint of structural portion of exterior walls
- Midpoint of structural portion of demising walls between strata lots

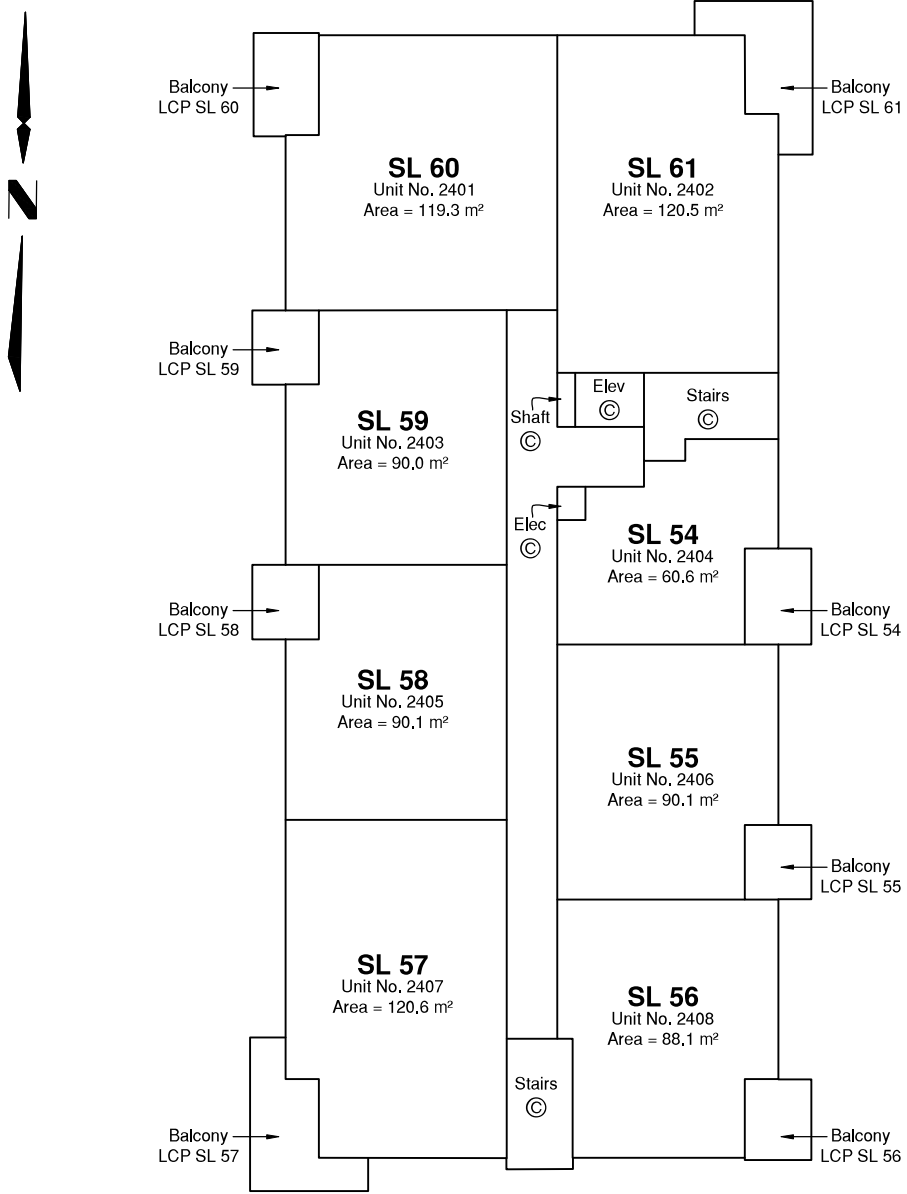

Plotted: 8/3/2023 10:40 AM User: Karla Herrera



202 - 1475 Ellis Street
Kelowna, BC

PROJECT REF./DRAWING No.
22-03760-001-DSC01-R2

Anna Niraz, BCLS 964
August 1st, 2023

BUILDING 2 - LEVEL 5 SL'S 62 TO 67 INCLUSIVE

Sheet 12 of 19 Sheets

PRE-STRATA PLAN PHASE 1



The intended plot size of this plan is 432mm in width by 280mm in height (B size) when plotted at a scale of 1:200.

LEGEND

- SL denotes Strata Lot
- ⊙ denotes Common Property
- LCP denotes Limited Common property for the Exclusive Use of Designated Strata Lot
- Mech denotes mechanic room
- Elev denotes elevator
- Vest denotes vestibule

Areas of Limited Common Property (Private Gardens and Balconies) lower/upper vertical extent are defined by the centre of the floor below/above or its extensions, or where there is no floor below/above, by the average height of a strata lot within the same building unless otherwise indicated.

Method of Measurement:

- Midpoint of structural portion of exterior walls
- Midpoint of structural portion of demising walls between strata lots

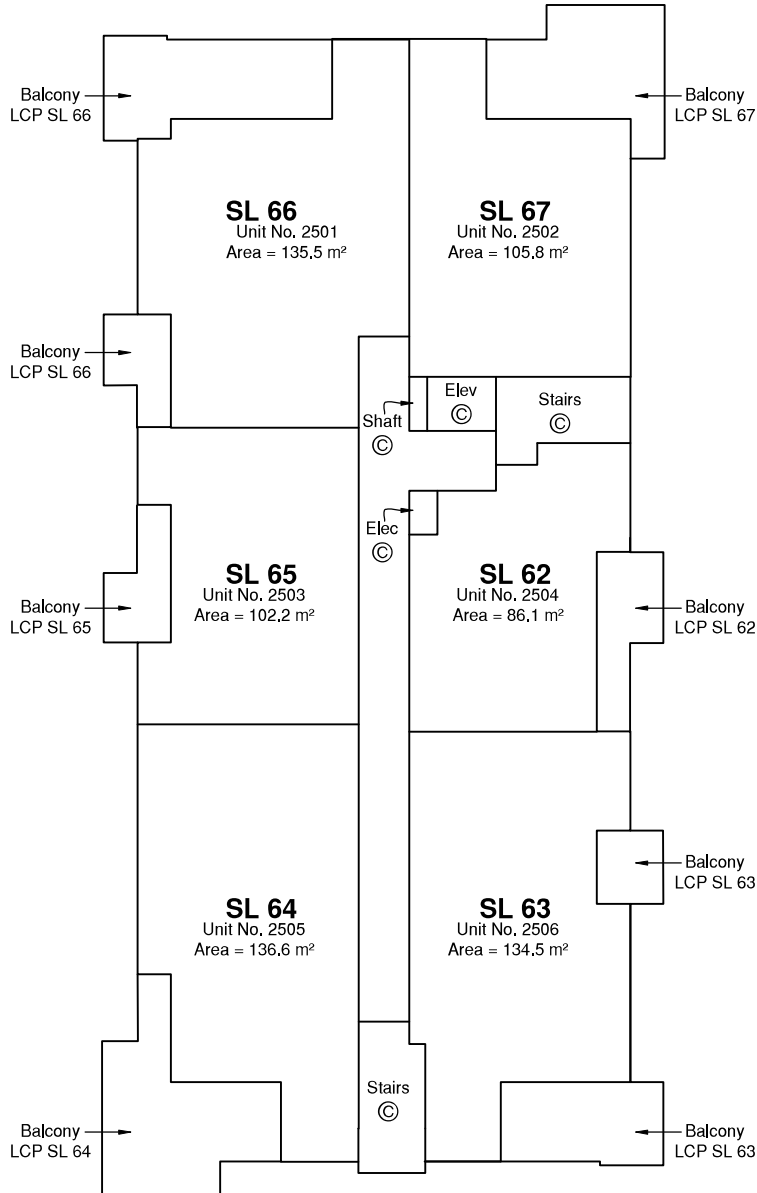

Plotted: 8/3/2023 10:40 AM User: Karla Herrera



202 - 1475 Ellis Street
Kelowna, BC

PROJECT REF./DRAWING No.
22-03760-001-DSC01-R2

Anna Niraz, BCLS 964
August 1st, 2023

BUILDING 2 - ROOF LEVEL

Sheet 13 of 19 Sheets

PRE-STRATA PLAN PHASE 1



The intended plot size of this plan is 432mm in width by 280mm in height (B size) when plotted at a scale of 1:200.

LEGEND

- SL denotes Strata Lot
- ⊙ denotes Common Property
- LCP denotes Limited Common property for the Exclusive Use of Designated Strata Lot
- Mech denotes mechanic room
- Elev denotes elevator
- Vest denotes vestibule

Areas of Limited Common Property (Private Gardens and Balconies) lower/upper vertical extent are defined by the centre of the floor below/above or its extensions, or where there is no floor below/above, by the average height of a strata lot within the same building unless otherwise indicated.

Method of Measurement:

- Midpoint of structural portion of exterior walls
- Midpoint of structural portion of demising walls between strata lots

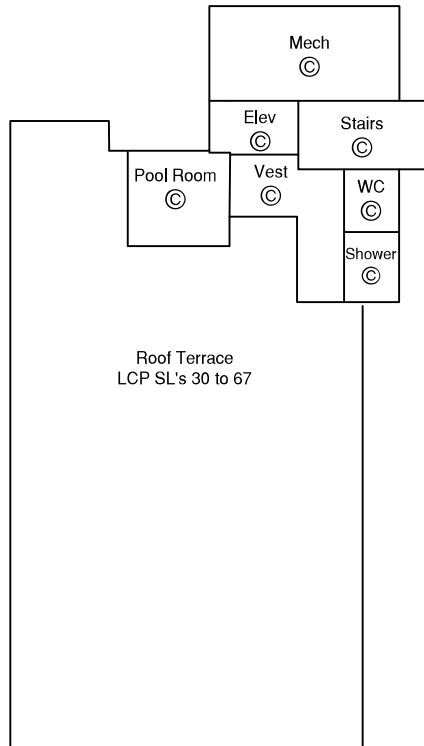

Plotted: 8/3/2023 10:40 AM User: Karla Herrera



202 - 1475 Ellis Street
Kelowna, BC

PROJECT REF./DRAWING No.
22-03760-001-DSC01-R2

Anna Niraz, BCLS 964
August 1st, 2023

BUILDING 3 - LEVEL 1 PART SL'S 68 TO 80 INCLUSIVE

Sheet 14 of 19 Sheets

PRE-STRATA PLAN PHASE 1



The intended plot size of this plan is 432mm in width by 280mm in height (B size) when plotted at a scale of 1:200.

LEGEND

- SL denotes Strata Lot
- ⊙ denotes Common Property
- LCP denotes Limited Common property for the Exclusive Use of Designated Strata Lot
- Mech denotes mechanic room
- Elev denotes elevator
- Vest denotes vestibule

Areas of Limited Common Property (Private Gardens and Balconies) lower/upper vertical extent are defined by the centre of the floor below/above or its extensions, or where there is no floor below/above, by the average height of a strata lot within the same building unless otherwise indicated.

Method of Measurement:

- Midpoint of structural portion of exterior walls
- Midpoint of structural portion of demising walls between strata lots

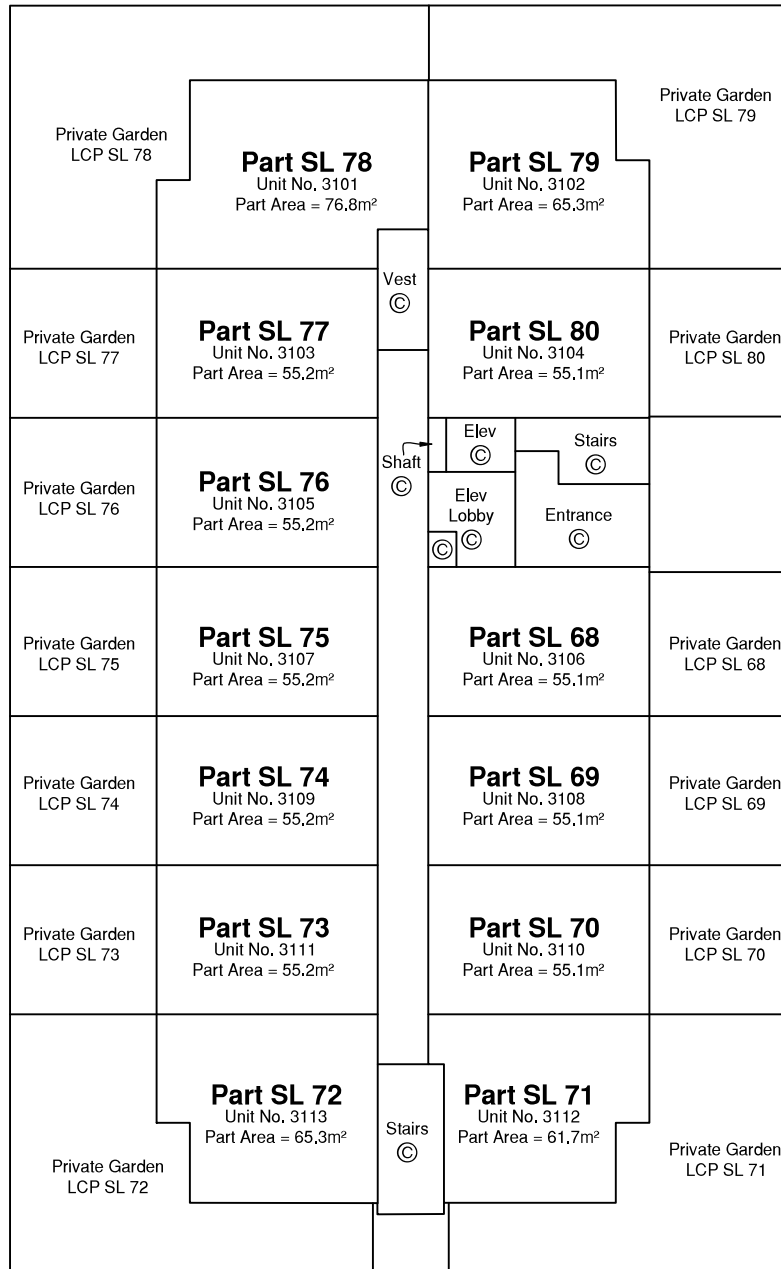

Plotted: 8/3/2023 10:40 AM User: Karla Herrera



202 - 1475 Ellis Street
Kelowna, BC

PROJECT REF./DRAWING No.
22-03760-001-DSC01-R2

Anna Niraz, BCLS 964
August 1st, 2023

BUILDING 3 - LEVEL 2 PART SL'S 68 TO 80 INCLUSIVE

PRE-STRATA PLAN PHASE 1



The intended plot size of this plan is 432mm in width by 280mm in height (B size) when plotted at a scale of 1:200.

LEGEND

- SL denotes Strata Lot
- ⊙ denotes Common Property
- LCP denotes Limited Common property for the Exclusive Use of Designated Strata Lot
- Mech denotes mechanic room
- Elev denotes elevator
- Vest denotes vestibule

Areas of Limited Common Property (Private Gardens and Balconies) lower/upper vertical extent are defined by the centre of the floor below/above or its extensions, or where there is no floor below/above, by the average height of a strata lot within the same building unless otherwise indicated.

Method of Measurement:

- Midpoint of structural portion of exterior walls
- Midpoint of structural portion of demising walls between strata lots

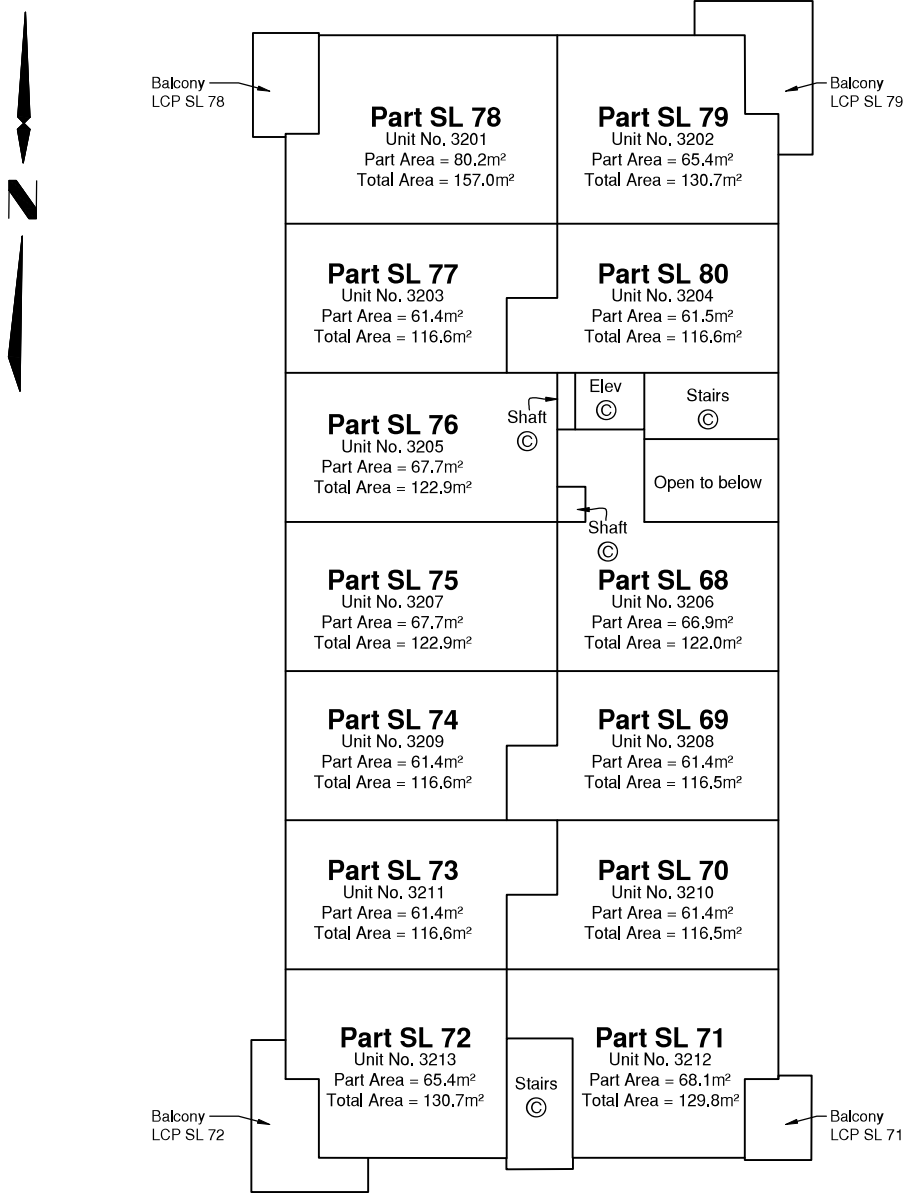

Plotted: 8/3/2023 10:40 AM User: Karla Herrera

GeoVerra
 202 - 1475 Ellis Street
 Kelowna, BC
 PROJECT REF./DRAWING No.
 22-03760-001-DSC01-R2

BUILDING 3 - LEVEL 3 SL'S 81 TO 88 INCLUSIVE

Sheet 16 of 19 Sheets

PRE-STRATA PLAN PHASE 1



The intended plot size of this plan is 432mm in width by 280mm in height (B size) when plotted at a scale of 1:200.

LEGEND

- SL denotes Strata Lot
- ⊙ denotes Common Property
- LCP denotes Limited Common property for the Exclusive Use of Designated Strata Lot
- Mech denotes mechanic room
- Elev denotes elevator
- Vest denotes vestibule

Areas of Limited Common Property (Private Gardens and Balconies) lower/upper vertical extent are defined by the centre of the floor below/above or its extensions, or where there is no floor below/above, by the average height of a strata lot within the same building unless otherwise indicated.

Method of Measurement:

- Midpoint of structural portion of exterior walls
- Midpoint of structural portion of demising walls between strata lots

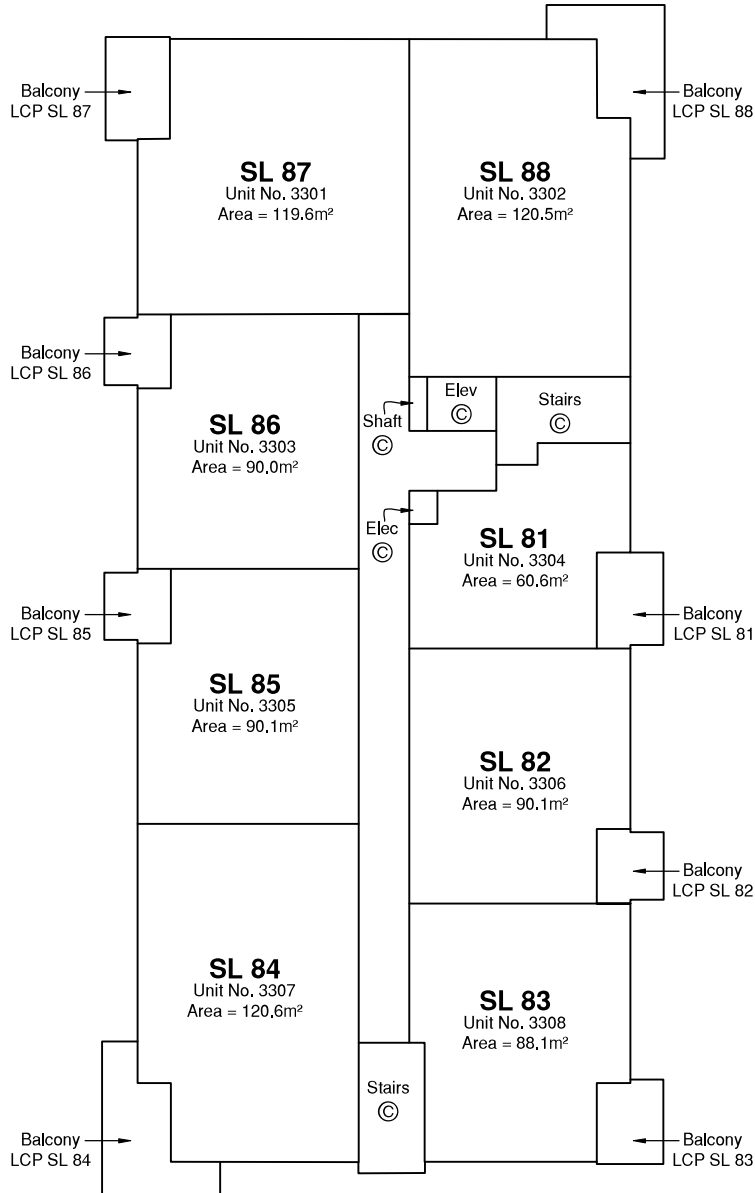

Plotted: 8/3/2023 10:40 AM User: Karla Herrera



202 - 1475 Ellis Street
Kelowna, BC

PROJECT REF./DRAWING No.
22-03760-001-DSC01-R2

BUILDING 3 - LEVEL 4 SL'S 89 TO 96 INCLUSIVE

Sheet 17 of 19 Sheets

PRE-STRATA PLAN PHASE 1



The intended plot size of this plan is 432mm in width by 280mm in height (B size) when plotted at a scale of 1:200.

LEGEND

- SL denotes Strata Lot
- ⊙ denotes Common Property
- LCP denotes Limited Common property for the Exclusive Use of Designated Strata Lot
- Mech denotes mechanic room
- Elev denotes elevator
- Vest denotes vestibule

Areas of Limited Common Property (Private Gardens and Balconies) lower/upper vertical extent are defined by the centre of the floor below/above or its extensions, or where there is no floor below/above, by the average height of a strata lot within the same building unless otherwise indicated.

Method of Measurement:

- Midpoint of structural portion of exterior walls
- Midpoint of structural portion of demising walls between strata lots

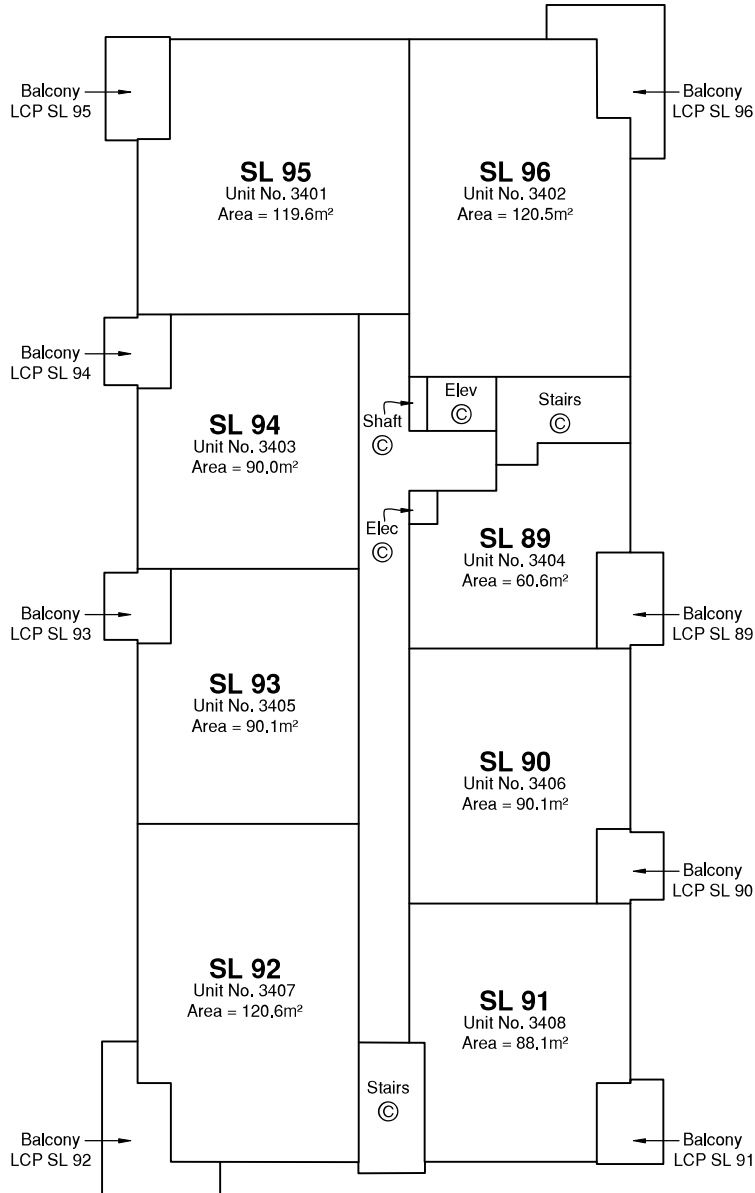

Plotted: 8/3/2023 10:40 AM User: Karla Herrera



202 - 1475 Ellis Street
Kelowna, BC

PROJECT REF./DRAWING No.
22-03760-001-DSC01-R2

Anna Niraz, BCLS 964
August 1st, 2023

BUILDING 3 - LEVEL 5 SL'S 97 TO 102 INCLUSIVE

Sheet 18 of 19 Sheets

PRE-STRATA PLAN PHASE 1



The intended plot size of this plan is 432mm in width by 280mm in height (B size) when plotted at a scale of 1:200.

LEGEND

- SL denotes Strata Lot
- ⊙ denotes Common Property
- LCP denotes Limited Common property for the Exclusive Use of Designated Strata Lot
- Mech denotes mechanic room
- Elev denotes elevator
- Vest denotes vestibule

Areas of Limited Common Property (Private Gardens and Balconies) lower/upper vertical extent are defined by the centre of the floor below/above or its extensions, or where there is no floor below/above, by the average height of a strata lot within the same building unless otherwise indicated.

Method of Measurement:

- Midpoint of structural portion of exterior walls
- Midpoint of structural portion of demising walls between strata lots

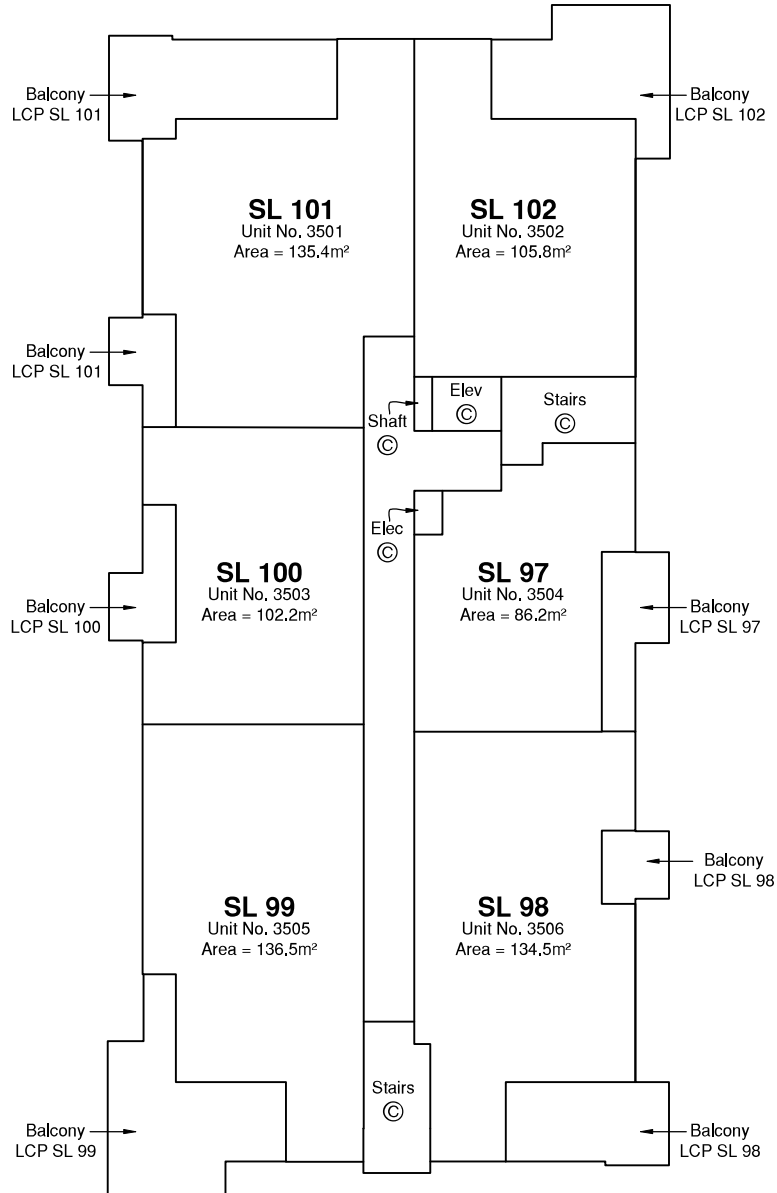

Plotted: 8/3/2023 10:40 AM User: Karla Herrera



202 - 1475 Ellis Street
Kelowna, BC

PROJECT REF./DRAWING No.
22-03760-001-DSC01-R2

Anna Niraz, BCLS 964
August 1st, 2023

BUILDING 3 - ROOF LEVEL

Sheet 19 of 19 Sheets

PRE-STRATA PLAN PHASE 1



The intended plot size of this plan is 432mm in width by 280mm in height (B size) when plotted at a scale of 1:200.

LEGEND

- SL denotes Strata Lot
- ⊙ denotes Common Property
- LCP denotes Limited Common property for the Exclusive Use of Designated Strata Lot
- Mech denotes mechanic room
- Elev denotes elevator
- Vest denotes vestibule

Areas of Limited Common Property (Private Gardens and Balconies) lower/upper vertical extent are defined by the centre of the floor below/above or its extensions, or where there is no floor below/above, by the average height of a strata lot within the same building unless otherwise indicated.

Method of Measurement:

- Midpoint of structural portion of exterior walls
- Midpoint of structural portion of demising walls between strata lots

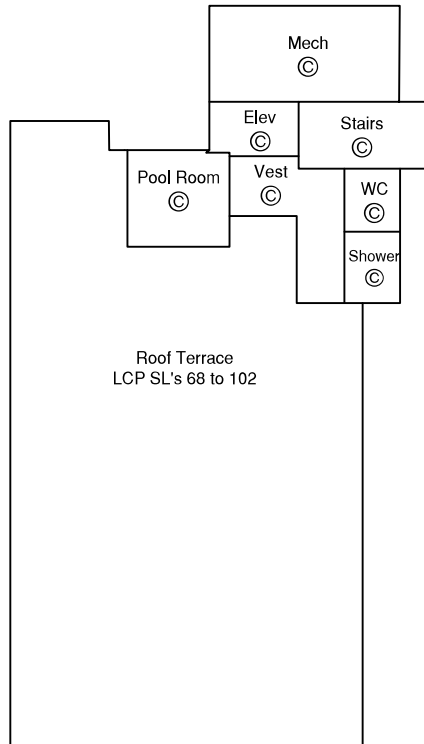

Plotted: 8/3/2023 10:40 AM User: Karla Herrera



202 - 1475 Ellis Street
Kelowna, BC

PROJECT REF./DRAWING No.
22-03760-001-DSC01-R2

Anna Niraz, BCLS 964
August 1st, 2023

EXHIBIT B
FORM P - PHASED STRATA PLAN DECLARATION
ORIGINAL FORM P

See attached.

FORM P

Strata Property Act

PHASED STRATA PLAN DECLARATION

(Section 221, 222)

We, 0929468 B.C. Ltd., of #900 - 900 West Hastings Street, Vancouver, B.C., Canada, declare:

1. That we intend to create a strata plan by way of phased development of the following land which we own:

<i>[parcel identifier]</i>	<i>[legal description]</i>
•	Lot • Section 23 Township 23 Range 2 West of the 6th Meridian Kootenay District Plan EPP•

2. That the plan of development is as follows:

- (a) The following is a schedule of the number of phases in the order in which the phases will be deposited in the Land Title Office and specifying any common facility to be constructed in conjunction with each particular phase:

Phase Number	Common Facilities
1	None
2	None

- (b) attached hereto as Schedule A is a sketch plan showing:
- (i) all the land to be included in the phased strata plan;
 - (ii) the proposed parcel boundaries;
 - (iii) the approximate boundaries of each phase; and
 - (iv) the approximate location of the common facilities.
- (c) the estimated date for the beginning of construction and completion of construction of each phase is as follows:

Phase Number	Estimated Date for Commencement of Construction	Estimated Date for Completion of Construction
1	August 1, 2023	September 1, 2025
2	August 1, 2024	September 1, 2026

- (d) the estimated unit entitlement of each phase and the estimated total unit entitlement of the completed development are as follows:

Phase Number	Unit Entitlement
1	10,946
2	10,946
Total:	21,892

- (e) the maximum number of units and the general type of residence or other structure to be built in each phase will be as follows:

Phase Number	No. of Units	No. of Buildings	Type of Structure
1	99	3	One (1) four-storey and two (2) five-storey buildings of load bearing steel stud and light weight steel truss construction constructed above a portion of a concrete underground parking facility.
2	99	3	One (1) four-storey and two (2) five-storey buildings of load bearing steel stud and light weight steel truss construction constructed above a portion of a concrete underground parking facility.
Total:	198	6	

3. We will elect to proceed with each phase on or by the following dates:

Phase Number	Date
1	August 1, 2024
2	August 1, 2025

[Signature page follows. Remainder of page left intentionally blank.]

0929468 B.C. LTD.

By: _____
Authorized Signatory

By: _____
Authorized Signatory

Date of Approval: _____ *

Signature of Approving Officer

City of Revelstoke

* Section 222(2) of the Act provides that approval expires after one year unless the first phase is deposited before that time.

SCHEDULE A
SKETCH PLAN

See attached.

SKETCH PLAN TO ACCOMPANY FORM P OF THE STRATA PROPERTY ACT FOR A PHASED STRATA DEVELOPMENT ON LOT B SECTION 23 TOWNSHIP 23 RANGE 2 WEST OF THE 6TH MERIDIAN KOOTENAY DISTRICT PLAN EPP125979 (Pending Registration)

BCGS 82L.100



The intended plot size of this plan is 432mm in width by 280mm in height (B size) when plotted at a scale of 1:1250.

LEGEND

- SL denotes Strata Lot
- © denotes Common Property
- · - denotes phase boundary

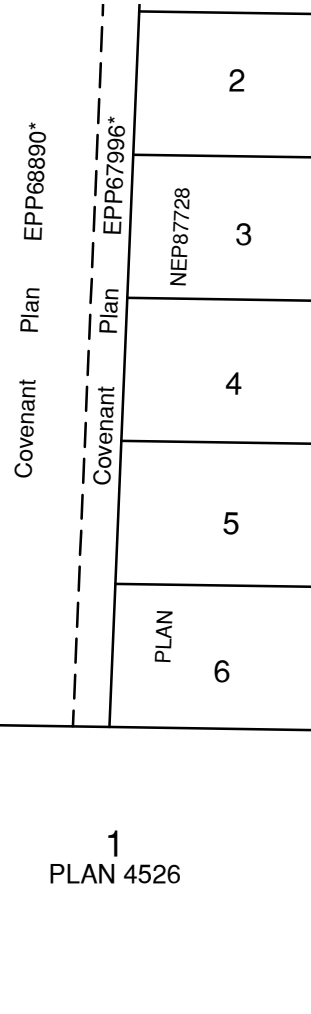
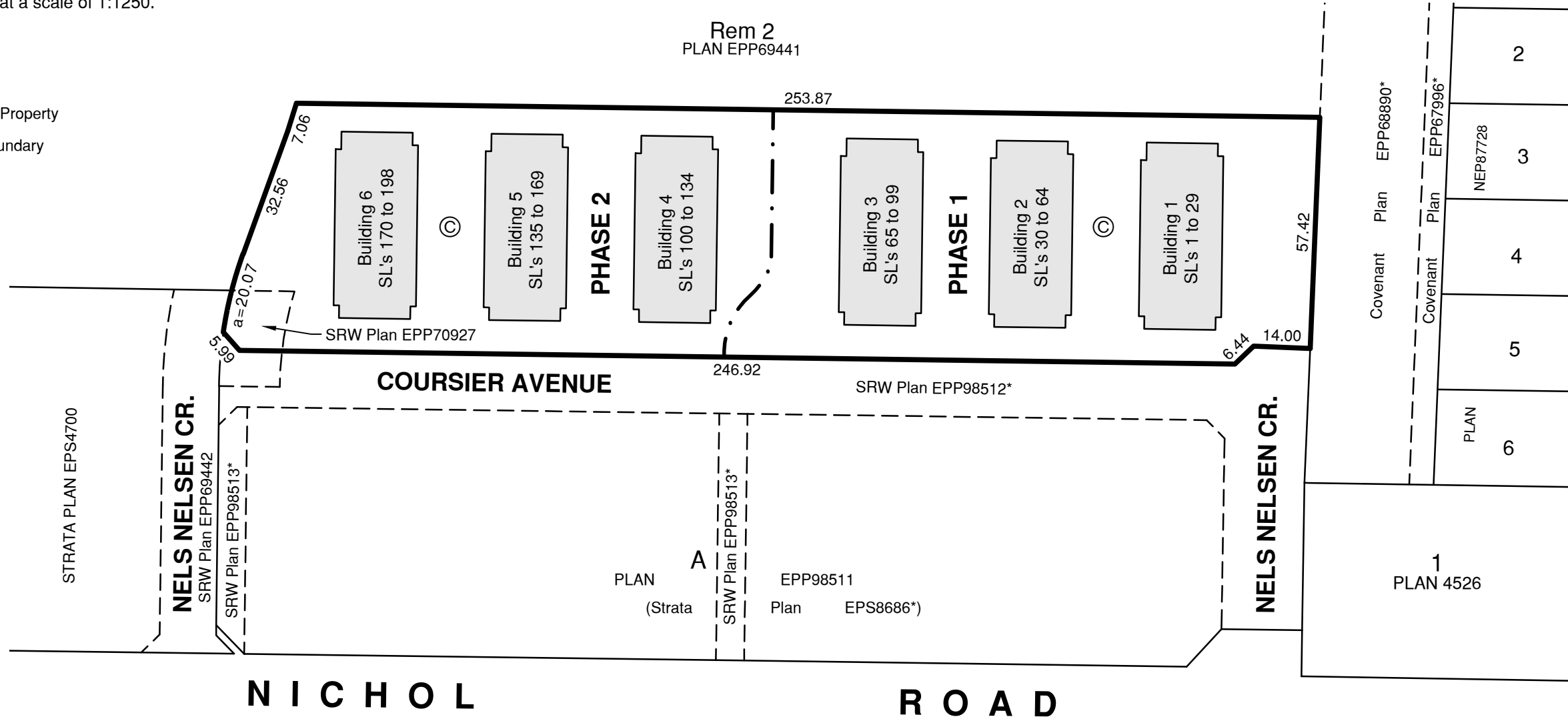

Plotted: 12/13/2022 12:30 PM User: Mike.Evans



202 - 1475 Ellis Street
Kelowna, BC

PROJECT REF./DRAWING No.
22-03760-001-FMP01

Project Name:
The Selkirks and Monashees at
MacKenzie Village

Civic Address:
Nichol Road, Revelstoke, BC

Phase 1 Strata Lots: 99
Phase 2 Strata Lots: 99
Total Strata Lots: 198

December 12, 2022

REVISED FORM P

See attached.

FORM P

Strata Property Act

PHASED STRATA PLAN DECLARATION

(Section 221, 222)

We, 0929468 B.C. Ltd., of #900 - 900 West Hastings Street, Vancouver, B.C., Canada, declare:

1. That we intend to create a strata plan by way of phased development of the following land which we own:

<i>[parcel identifier]</i>	<i>[legal description]</i>
•	Lot • Section 23 Township 23 Range 2 West of the 6th Meridian Kootenay District Plan EPP•

2. That the plan of development is as follows:

- (a) The following is a schedule of the number of phases in the order in which the phases will be deposited in the Land Title Office and specifying any common facility to be constructed in conjunction with each particular phase:

Phase Number	Common Facilities
1	None
2	None

- (b) attached hereto as Schedule A is a sketch plan showing:
- (i) all the land to be included in the phased strata plan;
 - (ii) the proposed parcel boundaries;
 - (iii) the approximate boundaries of each phase; and
 - (iv) the approximate location of the common facilities.
- (c) the estimated date for the beginning of construction and completion of construction of each phase is as follows:

Phase Number	Estimated Date for Commencement of Construction	Estimated Date for Completion of Construction
1	December 1, 2023	September 1, 2025
2	August 1, 2024	September 1, 2026

- (d) the estimated unit entitlement of each phase and the estimated total unit entitlement of the completed development are as follows:

Phase Number	Unit Entitlement
1	10,852
2	10,849
Total:	21,701

- (e) the maximum number of units and the general type of residence or other structure to be built in each phase will be as follows:

Phase Number	No. of Units	No. of Buildings	Type of Structure
1	102	3	One (1) four-storey and two (2) five-storey buildings of load bearing steel stud and light weight steel truss construction constructed above a portion of a concrete underground parking facility.
2	102	3	One (1) four-storey and two (2) five-storey buildings of load bearing steel stud and light weight steel truss construction constructed above a portion of a concrete underground parking facility.
Total:	204	6	

3. We will elect to proceed with each phase on or by the following dates:

Phase Number	Date
1	August 1, 2024
2	August 1, 2025

[Signature page follows. Remainder of page left intentionally blank.]

0929468 B.C. LTD.

By: _____
Authorized Signatory

By: _____
Authorized Signatory

Date of Approval: _____ *

Signature of Approving Officer

City of Revelstoke

* Section 222(2) of the Act provides that approval expires after one year unless the first phase is deposited before that time.

SCHEDULE A
SKETCH PLAN

See attached.

SKETCH PLAN TO ACCOMPANY FORM P OF THE STRATA PROPERTY ACT FOR A PHASED STRATA DEVELOPMENT ON LOT B SECTION 23 TOWNSHIP 23 RANGE 2 WEST OF THE 6TH MERIDIAN KOOTENAY DISTRICT PLAN EPP125979 (Pending Registration)

BCGS 82L.100



The intended plot size of this plan is 432mm in width by 280mm in height (B size) when plotted at a scale of 1:1250.

LEGEND

- SL denotes Strata Lot
- © denotes Common Property
- · - denotes phase boundary

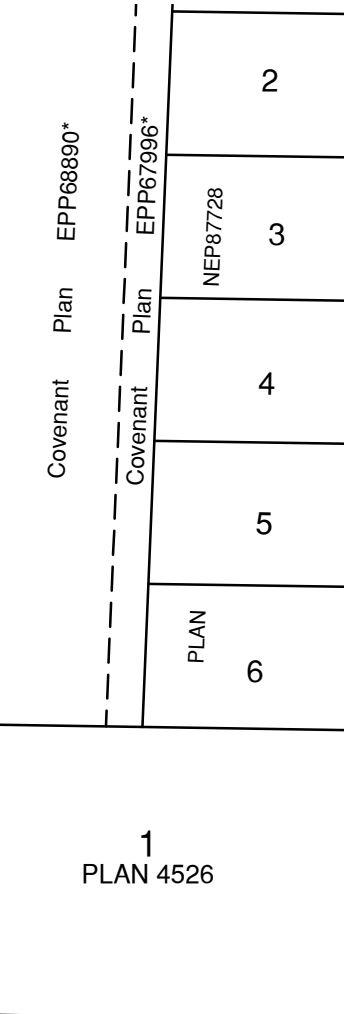
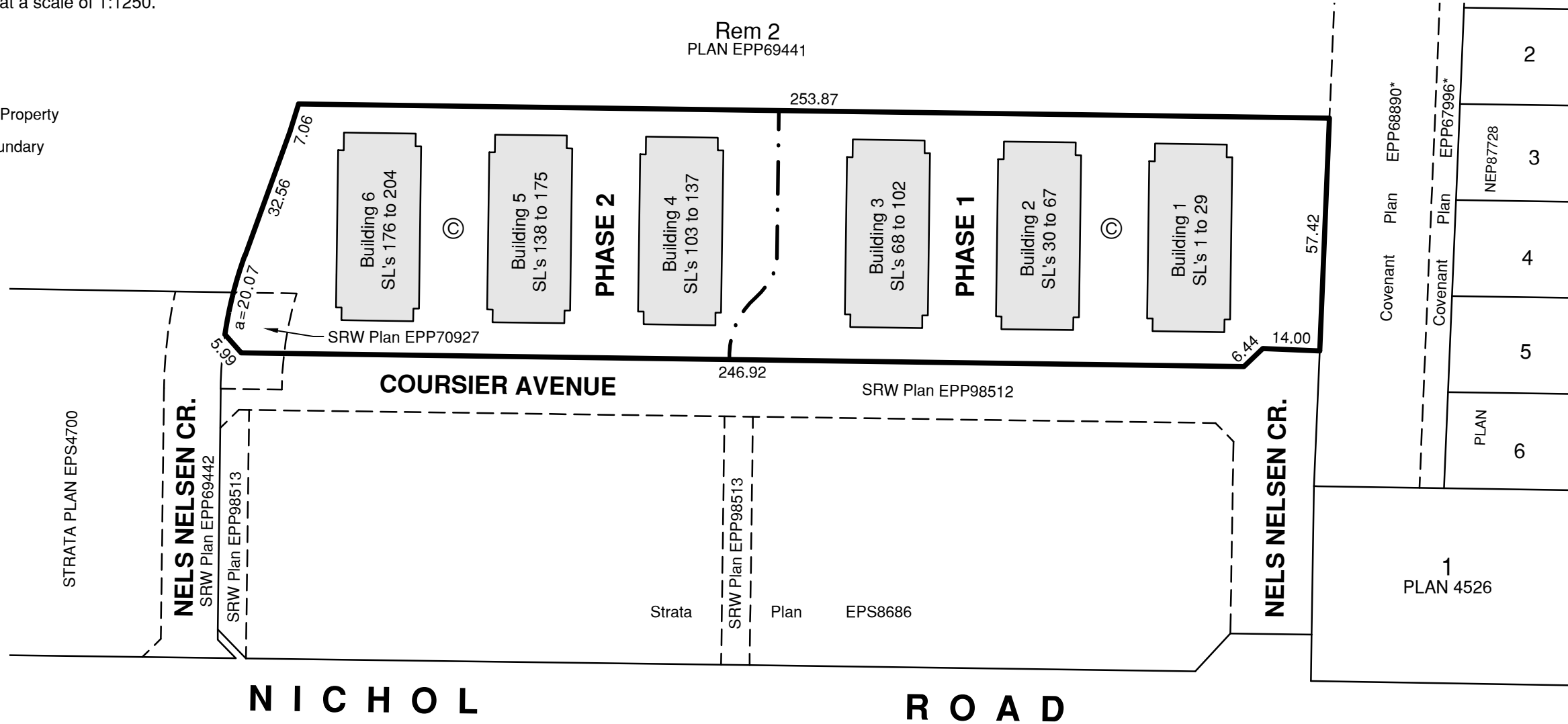

Plotted: 8/4/2023 7:18 AM User: Karla.Herrera



202 - 1475 Ellis Street
Kelowna, BC

PROJECT REF./DRAWING No.
22-03760-001-FMP01-R2

Project Name:
The Selkirks and Monashees at
MacKenzie Village

Civic Address:
Nichol Road, Revelstoke, BC

Phase 1 Strata Lots: 102
Phase 2 Strata Lots: 102
Total Strata Lots: 204

August 4th, 2023

EXHIBIT C-1

PROPOSED FORM V – SCHEDULE OF ESTIMATED UNIT ENTITLEMENT – PHASE 1

See attached.

Strata Property Act

FORM V

SCHEDULE OF UNIT ENTITLEMENT

(Sections 245(a), 246, 264)

Re: Strata Plan (unregistered), being a Phase 1 Pre-strata plan of

PID unavailable PART LOT B SECTION 23 TOWNSHIP 23 RANGE 2 WEST OF THE
6TH MERIDIAN KOOTENAY DISTRICT PLAN EPP125979
(Pending Registration)

STRATA PLAN CONSISTING ENTIRELY OF RESIDENTIAL STRATA LOTS

The unit entitlement for each residential strata lot is one of the following, as set out in the following table:

- (a) the habitable area of the strata lot, in square metres, rounded to the nearest whole number as determined by a British Columbia land surveyor as set out in section 246(3)(a)(i) of the *Strata Property Act*.

Certificate of British Columbia Land Surveyor

I, Anna Niraz, a British Columbia land surveyor, certify that the following table reflects the habitable area of each residential strata lot.

Date: August 2, 2023.



Signature

OR

- (b) a whole number that is the same for all of the residential strata lots as set out in section 246(3)(a)(ii) of the *Strata Property Act*.

OR

- (c) a number that is approved by the Superintendent of Real Estate in accordance with section 246(3)(a)(iii) of the *Strata Property Act*.

Signature of Superintendent of Real Estate

Strata Lot No.	Sheet No.	Habitable Area in m ²	Unit Entitlement	%* of Total Unit Entitlement**
1	3/4	122.0	122	1.1%
2	3/4	116.5	117	1.1%
3	3/4	116.5	117	1.1%
4	3/4	129.8	130	1.2%
5	3/4	130.7	131	1.2%
6	3/4	116.6	117	1.1%
7	3/4	116.6	117	1.1%
8	3/4	122.9	123	1.1%
9	3/4	122.9	123	1.1%
10	3/4	116.6	117	1.1%
11	3/4	157.0	157	1.4%
12	3/4	130.7	131	1.2%
13	3/4	116.6	117	1.1%
14	5	60.6	61	0.6%
15	5	90.1	90	0.8%
16	5	88.1	88	0.8%
17	5	120.6	121	1.1%
18	5	90.1	90	0.8%
19	5	90.0	90	0.8%
20	5	119.6	120	1.1%
21	5	120.5	121	1.1%
22	6	60.6	61	0.6%
23	6	90.1	90	0.8%
24	6	87.9	88	0.8%
25	6	120.8	121	1.1%
26	6	90.1	90	0.8%
27	6	90.0	90	0.8%
28	6	119.6	120	1.1%
29	6	120.7	121	1.1%

30	8	64.7	65	0.6%
31	8	65.8	66	0.6%
32	8	87.9	88	0.8%
33	8	121.2	121	1.1%
34	8	90.5	91	0.8%
35	8	90.6	91	0.8%
36	8	120.4	120	1.1%
37	8	121.3	121	1.1%
38	9	64.6	65	0.6%
39	9	65.7	66	0.6%
40	9	88.1	88	0.8%
41	9	120.7	121	1.1%
42	9	90.2	90	0.8%
43	9	90.3	90	0.8%
44	9	119.7	120	1.1%
45	9	120.8	121	1.1%
46	10	60.6	61	0.6%
47	10	90.1	90	0.8%
48	10	89.5	90	0.8%
49	10	120.6	121	1.1%
50	10	90.1	90	0.8%
51	10	90.1	90	0.8%
52	10	119.6	120	1.1%
53	10	120.5	121	1.1%
54	11	60.6	61	0.6%
55	11	90.1	90	0.8%
56	11	88.1	88	0.8%
57	11	120.6	121	1.1%
58	11	90.1	90	0.8%
59	11	90.0	90	0.8%

60	11	119.3	119	1.1%
61	11	120.5	121	1.1%
62	12	86.1	86	0.8%
63	12	134.5	135	1.2%
64	12	136.6	137	1.3%
65	12	102.2	102	0.9%
66	12	135.5	136	1.3%
67	12	105.8	106	1.0%
68	14/15	122.0	122	1.1%
69	14/15	116.5	117	1.1%
70	14/15	116.5	117	1.1%
71	14/15	129.8	130	1.2%
72	14/15	130.7	131	1.2%
73	14/15	116.6	117	1.1%
74	14/15	116.6	117	1.1%
75	14/15	122.9	123	1.1%
76	14/15	122.9	123	1.1%
77	14/15	116.6	117	1.1%
78	14/15	157.0	157	1.4%
79	14/15	130.7	131	1.2%
80	14/15	116.6	117	1.1%
81	16	60.6	61	0.6%
82	16	90.1	90	0.8%
83	16	88.1	88	0.8%
84	16	120.6	121	1.1%
85	16	90.1	90	0.8%
86	16	90.0	90	0.8%
87	16	119.6	120	1.1%
88	16	120.5	121	1.1%
89	17	60.6	61	0.6%

90	17	90.1	90	0.8%
91	17	88.1	88	0.8%
92	17	120.6	121	1.1%
93	17	90.1	90	0.8%
94	17	90.0	90	0.8%
95	17	119.6	120	1.1%
96	17	120.5	121	1.1%
97	18	86.2	86	0.8%
98	18	134.5	135	1.2%
99	18	136.5	137	1.3%
100	18	102.2	102	0.9%
101	18	135.4	135	1.2%
102	18	105.8	106	1.0%
Total number of lots: 102			Total unit entitlement: 10852	

- * expression of percentage is for informational purposes only and has no legal effect
- ** not required for a phase of a phased strata plan

Date:

Signature of Owner Developer

Signature of Superintendent of Real Estate (if submitted under section 264 of the Act)

EXHIBIT E-1

PROPOSED INTERIM BUDGET OF OPERATING EXPENSES – PHASE 1

See attached.

**Mackenzie Village Selkirks and Monashees Phase 1
PROPOSED OPERATING BUDGET**

ACCOUNT TITLE	PROPOSED
<u>REVENUE</u>	
Maintenance Fee Revenue	\$ 499,373.60
Interest Income	0.00
TOTAL REVENUE	\$ 499,373.60
<u>EXPENSES</u>	
Administration	
Audit Fees	\$ 375.00
Insurance	98,000.00
Insurance Appraisal	700.00
Telephone & Internet	2,250.00
Professional Fees	2,250.00
Management Fees	28,950.00
Photocopy / Postage / Courier	1,500.00
Miscellaneous	1,250.00
Total Administration	135,275.00
Building	
Carpet Cleaning	1,500.00
Window Cleaning	3,750.00
Fire Alarm Monitoring	1,000.00
Fire Equipment Maintenance	2,500.00
Gutter Cleaning	3,500.00
Pest Control	1,250.00
Elevator	28,500.00
Dryer Vent Cleaning	3,250.00
Janitorial/Caretaker Services	48,900.00
Supplies	1,500.00
Emergency Generator	2,500.00
Security	3,500.00
R&M Interior	7,500.00
R&M - General	19,251.00
Total Building	128,401.00
Utilities	
Electricity	42,000.00
Garbage Disposal	22,500.00
Water & Sewage	48,500.00
Total Utilities	113,000.00

Grounds Maintenance	
Landscaping	42,000.00
Irrigation	1,250.00
Snow Removal	16,250.00
Tree Maintenance	2,500.00
Contribution to MV Community Association for Road and Trail System and Bus Service	11,800.00
Total Grounds Maintenance	<u>73,800.00</u>
Recreation Area	
Amenity Maintenance	3,500.00
Spa Chemicals and Maintenance	1,850.00
Total Recreation Area	<u>3,500.00</u>
TOTAL EXPENSES	\$ 453,976.00
Transfer to CRF	\$ 45,397.60
TOTAL EXPENSES & TRANSFERS	<u>\$ 499,373.60</u>
CURRENT YR OP SURPLUS (DEFICIT)	<u>\$ 0.00</u>
OPENING BALANCE OP SURPLUS (DEFICIT)	\$
ENDING BALANCE OP SURPLUS (DEFICIT)	<u><u>\$ 0.00</u></u>

EXHIBIT F

**CUMULATIVE BUDGETS OF OPERATING EXPENSES FOR PHASES 1 – 2 (FOR
ILLUSTRATIVE PURPOSES ONLY)**

See attached.

**Mackenzie Village Selkirks and Monashees Phase 1 and 2
PROPOSED OPERATING BUDGET**

ACCOUNT TITLE	BUDGET	PROPOSED
	<i>Phase 1</i>	<i>Phase 1 & 2</i>
<u>REVENUE</u>		
Maintenance Fee Revenue	\$ 499,923.60	\$ 963,965.20
Interest Income	0.00	0.00
TOTAL REVENUE	\$ 499,923.60	\$ 963,965.20
<u>EXPENSES</u>		
Administration		
Audit Fees	\$ 375.00	\$ 750.00
Insurance	98,000.00	178,500.00
Insurance Appraisal	700.00	1,400.00
Telephone & Internet	2,250.00	4,500.00
Professional Fees	2,250.00	4,500.00
Management Fees	28,950.00	57,900.00
Photocopy / Postage / Courier	1,500.00	3,000.00
Miscellaneous	1,250.00	2,500.00
Total Administration	135,275.00	253,050.00
Building		
Carpet Cleaning	1,500.00	3,000.00
Window Cleaning	3,750.00	7,500.00
Fire Alarm Monitoring	1,000.00	2,000.00
Fire Equipment Maintenance	2,500.00	5,000.00
Gutter Cleaning	3,500.00	7,000.00
Pest Control	1,250.00	2,500.00
Elevator	28,500.00	57,000.00
Dryer Vent Cleaning	3,250.00	5,500.00
Janitorial Services	48,900.00	78,900.00
Supplies	1,500.00	1,000.00
Emergency Generator	2,500.00	5,000.00
Security	3,500.00	25,500.00
R&M Interior	7,500.00	15,000.00
R&M - General	19,251.00	38,502.00
Total Building	128,401.00	253,402.00
Utilities		
Electricity	42,500.00	80,000.00
Garbage Disposal	22,500.00	45,000.00
Water & Sewage	48,500.00	96,000.00
Total Utilities	113,500.00	221,000.00
Grounds Maintenance		
Landscaping	42,000.00	78,000.00
Irrigation	1,250.00	2,500.00
Snow Removal	16,250.00	32,500.00
Tree Maintenance	2,500.00	5,000.00
Contribution to MV Community Association for Road and Trail System and Bus Service	11,800.00	23,880.00
Total Grounds Maintenance	73,800.00	141,880.00
Recreation Area		

Amenity Maintenance	3,500.00	7,000.00
Spa Chemicals and Maintenance	<u>1,850.00</u>	<u>3,700.00</u>
Total Recreation Area	3,500.00	7,000.00
TOTAL EXPENSES	\$ 454,476.00	\$ 876,332.00
Transfer to CRF	\$ <u>45,447.60</u>	\$ <u>87,633.20</u>
TOTAL EXPENSES & TRANSFERS	\$ 499,923.60	\$ 963,965.20
CURRENT YR OP SURPLUS (DEFICIT)	\$ <u>0.00</u>	\$ <u>0.00</u>
OPENING BALANCE OP SURPLUS (DEFICIT)	\$ <u> </u>	\$ <u> </u>
ENDING BALANCE OP SURPLUS (DEFICIT)	\$ <u><u>0.00</u></u>	\$ <u><u>0.00</u></u>

EXHIBIT G-1

ESTIMATED MONTHLY ASSESSMENTS – PHASE 1

See attached.

**Mackenzie Village Selkirks and Monashees Phase 1
PROPOSED FEE SCHEDULE**

S.L.	UNIT	U/E	OPERATING FUND CONTRIBUTION	CRF FUND CONTRIBUTION	TOTAL MONTHLY FEES DUE
1		122	425.31	42.53	467.84
2		117	407.87	40.79	448.66
3		117	407.87	40.79	448.66
4		130	453.19	45.32	498.51
5		131	456.68	45.67	502.35
6		117	407.87	40.79	448.66
7		117	407.87	40.79	448.66
8		123	428.79	42.88	471.67
9		123	428.79	42.88	471.67
10		117	407.87	40.79	448.66
11		157	547.32	54.73	602.05
12		131	456.68	45.67	502.35
13		117	407.87	40.79	448.66
14		61	212.65	21.27	233.92
15		90	313.75	31.38	345.13
16		88	306.78	30.68	337.46
17		121	421.82	42.18	464.00
18		90	313.75	31.38	345.13
19		90	313.75	31.38	345.13
20		120	418.34	41.83	460.17
21		121	421.82	42.18	464.00
22		61	212.65	21.27	233.92
23		90	313.75	31.38	345.13
24		88	306.78	30.68	337.46
25		121	421.82	42.18	464.00
26		90	313.75	31.38	345.13
27		90	313.75	31.38	345.13
28		120	418.34	41.83	460.17
29		121	421.82	42.18	464.00
30		65	226.60	22.66	249.26
31		66	230.08	23.01	253.09
32		88	306.78	30.68	337.46
33		121	421.82	42.18	464.00
34		91	317.24	31.72	348.96
35		91	317.24	31.72	348.96
36		120	418.34	41.83	460.17
37		121	421.82	42.18	464.00
38		65	226.60	22.66	249.26
39		66	230.08	23.01	253.09
40		88	306.78	30.68	337.46
41		121	421.82	42.18	464.00
42		90	313.75	31.38	345.13
43		90	313.75	31.38	345.13
44		120	418.34	41.83	460.17
45		121	421.82	42.18	464.00
46		61	212.65	21.27	233.92
47		90	313.75	31.38	345.13
48		90	313.75	31.38	345.13
49		121	421.82	42.18	464.00
50		90	313.75	31.38	345.13
51		90	313.75	31.38	345.13
52		120	418.34	41.83	460.17
53		121	421.82	42.18	464.00
54		61	212.65	21.27	233.92
55		90	313.75	31.38	345.13
56		88	306.78	30.68	337.46
57		121	421.82	42.18	464.00

**Mackenzie Village Selkirks and Monashees Phase 1
PROPOSED FEE SCHEDULE**

S.L.	UNIT	U/E	OPERATING FUND CONTRIBUTION	CRF FUND CONTRIBUTION	TOTAL MONTHLY FEES DUE
58		90	313.75	31.38	345.13
59		90	313.75	31.38	345.13
60		119	414.85	41.48	456.33
61		121	421.82	42.18	464.00
62		86	299.81	29.98	329.79
63		135	470.63	47.06	517.69
64		137	477.60	47.76	525.36
65		102	355.58	35.56	391.14
66		136	474.11	47.41	521.52
67		106	369.53	36.95	406.48
68		122	425.31	42.53	467.84
69		117	407.87	40.79	448.66
70		117	407.87	40.79	448.66
71		130	453.19	45.32	498.51
72		131	456.68	45.67	502.35
73		117	407.87	40.79	448.66
74		117	407.87	40.79	448.66
75		123	428.79	42.88	471.67
76		123	428.79	42.88	471.67
77		117	407.87	40.79	448.66
78		157	547.32	54.73	602.05
79		131	456.68	45.67	502.35
80		117	407.87	40.79	448.66
81		61	212.65	21.27	233.92
82		90	313.75	31.38	345.13
83		88	306.78	30.68	337.46
84		121	421.82	42.18	464.00
85		90	313.75	31.38	345.13
86		90	313.75	31.38	345.13
87		120	418.34	41.83	460.17
88		121	421.82	42.18	464.00
89		61	212.65	21.27	233.92
90		90	313.75	31.38	345.13
91		88	306.78	30.68	337.46
92		121	421.82	42.18	464.00
93		90	313.75	31.38	345.13
94		90	313.75	31.38	345.13
95		120	418.34	41.83	460.17
96		121	421.82	42.18	464.00
97		86	299.81	29.98	329.79
98		135	470.63	47.06	517.69
99		137	477.60	47.76	525.36
100		102	355.58	35.56	391.14
101		135	470.63	47.06	517.69
102		106	369.53	36.95	406.48
TOTAL U/E		10,852	37,831.30	3,783.24	41,614.54
			x 12	x 12	x 12
			453,975.60	45,398.88	499,374.48

EXHIBIT H

**ESTIMATED CUMULATIVE ASSESSMENTS FOR PHASES 1 – 2
(FOR ILLUSTRATIVE PURPOSES ONLY)**

See attached.

**Mackenzie Village Selkirks and Monashees Phase 1 and 2
PROPOSED FEE SCHEDULE**

S.L.	UNIT	U/E	OPERATING FUND CONTRIBUTION	CRF FUND CONTRIBUTION	TOTAL MONTHLY FEES DUE
1		122	410.55	41.06	451.61
2		117	393.73	39.37	433.10
3		117	393.73	39.37	433.10
4		130	437.47	43.75	481.22
5		131	440.84	44.08	484.92
6		117	393.73	39.37	433.10
7		117	393.73	39.37	433.10
8		123	413.92	41.39	455.31
9		123	413.92	41.39	455.31
10		117	393.73	39.37	433.10
11		157	528.34	52.83	581.17
12		131	440.84	44.08	484.92
13		117	393.73	39.37	433.10
14		61	205.27	20.53	225.80
15		90	302.86	30.29	333.15
16		88	296.14	29.61	325.75
17		121	407.18	40.72	447.90
18		90	302.86	30.29	333.15
19		90	302.86	30.29	333.15
20		120	403.82	40.38	444.20
21		121	407.18	40.72	447.90
22		61	205.27	20.53	225.80
23		90	302.86	30.29	333.15
24		88	296.14	29.61	325.75
25		121	407.18	40.72	447.90
26		90	302.86	30.29	333.15
27		90	302.86	30.29	333.15
28		120	403.82	40.38	444.20
29		121	407.18	40.72	447.90
30		65	218.74	21.87	240.61
31		66	222.10	22.21	244.31
32		88	296.14	29.61	325.75
33		121	407.18	40.72	447.90
34		91	306.23	30.62	336.85
35		91	306.23	30.62	336.85
36		120	403.82	40.38	444.20
37		121	407.18	40.72	447.90
38		65	218.74	21.87	240.61
39		66	222.10	22.21	244.31
40		88	296.14	29.61	325.75
41		121	407.18	40.72	447.90
42		90	302.86	30.29	333.15
43		90	302.86	30.29	333.15
44		120	403.82	40.38	444.20
45		121	407.18	40.72	447.90
46		61	205.27	20.53	225.80
47		90	302.86	30.29	333.15
48		90	302.86	30.29	333.15
49		121	407.18	40.72	447.90
50		90	302.86	30.29	333.15
51		90	302.86	30.29	333.15

**Mackenzie Village Selkirks and Monashees Phase 1 and 2
PROPOSED FEE SCHEDULE**

S.L.	UNIT	U/E	OPERATING FUND CONTRIBUTION	CRF FUND CONTRIBUTION	TOTAL MONTHLY FEES DUE
52		120	403.82	40.38	444.20
53		121	407.18	40.72	447.90
54		61	205.27	20.53	225.80
55		90	302.86	30.29	333.15
56		88	296.14	29.61	325.75
57		121	407.18	40.72	447.90
58		90	302.86	30.29	333.15
59		90	302.86	30.29	333.15
60		119	400.45	40.05	440.50
61		121	407.18	40.72	447.90
62		86	289.41	28.94	318.35
63		135	454.30	45.43	499.73
64		137	461.03	46.10	507.13
65		102	343.25	34.32	377.57
66		136	457.66	45.77	503.43
67		106	356.71	35.67	392.38
68		122	410.55	41.06	451.61
69		117	393.73	39.37	433.10
70		117	393.73	39.37	433.10
71		130	437.47	43.75	481.22
72		131	440.84	44.08	484.92
73		117	393.73	39.37	433.10
74		117	393.73	39.37	433.10
75		123	413.92	41.39	455.31
76		123	413.92	41.39	455.31
77		117	393.73	39.37	433.10
78		157	528.34	52.83	581.17
79		131	440.84	44.08	484.92
80		117	393.73	39.37	433.10
81		61	205.27	20.53	225.80
82		90	302.86	30.29	333.15
83		88	296.14	29.61	325.75
84		121	407.18	40.72	447.90
85		90	302.86	30.29	333.15
86		90	302.86	30.29	333.15
87		120	403.82	40.38	444.20
88		121	407.18	40.72	447.90
89		61	205.27	20.53	225.80
90		90	302.86	30.29	333.15
91		88	296.14	29.61	325.75
92		121	407.18	40.72	447.90
93		90	302.86	30.29	333.15
94		90	302.86	30.29	333.15
95		120	403.82	40.38	444.20
96		121	407.18	40.72	447.90
97		86	289.41	28.94	318.35
98		135	454.30	45.43	499.73
99		137	461.03	46.10	507.13
100		102	343.25	34.32	377.57
101		135	454.30	45.43	499.73
102		106	356.71	35.67	392.38

**Mackenzie Village Selkirks and Monashees Phase 1 and 2
PROPOSED FEE SCHEDULE**

S.L.	UNIT	U/E	OPERATING FUND CONTRIBUTION	CRF FUND CONTRIBUTION	TOTAL MONTHLY FEES DUE
103		122	410.55	41.06	451.61
104		117	393.73	39.37	433.10
105		117	393.73	39.37	433.10
106		130	437.47	43.75	481.22
107		131	440.84	44.08	484.92
108		117	393.73	39.37	433.10
109		117	393.73	39.37	433.10
110		123	413.92	41.39	455.31
111		123	413.92	41.39	455.31
112		117	393.73	39.37	433.10
113		157	528.34	52.83	581.17
114		131	440.84	44.08	484.92
115		117	393.73	39.37	433.10
116		61	205.27	20.53	225.80
117		90	302.86	30.29	333.15
118		88	296.14	29.61	325.75
119		121	407.18	40.72	447.90
120		90	302.86	30.29	333.15
121		90	302.86	30.29	333.15
122		120	403.82	40.38	444.20
123		121	407.18	40.72	447.90
124		61	205.27	20.53	225.80
125		90	302.86	30.29	333.15
126		88	296.14	29.61	325.75
127		121	407.18	40.72	447.90
128		90	302.86	30.29	333.15
129		90	302.86	30.29	333.15
130		120	403.82	40.38	444.20
131		121	407.18	40.72	447.90
132		86	289.41	28.94	318.35
133		135	454.30	45.43	499.73
134		137	461.03	46.10	507.13
135		102	343.25	34.32	377.57
136		135	454.30	45.43	499.73
137		106	356.71	35.67	392.38
138		65	218.74	21.87	240.61
139		66	222.10	22.21	244.31
140		88	296.14	29.61	325.75
141		121	407.18	40.72	447.90
142		91	306.23	30.62	336.85
143		91	306.23	30.62	336.85
144		120	403.82	40.38	444.20
145		121	407.18	40.72	447.90
146		65	218.74	21.87	240.61
147		66	222.10	22.21	244.31
148		88	296.14	29.61	325.75
149		121	407.18	40.72	447.90
150		90	302.86	30.29	333.15
151		90	302.86	30.29	333.15
152		119	400.45	40.05	440.50
153		120	403.82	40.38	444.20

**Mackenzie Village Selkirks and Monashees Phase 1 and 2
PROPOSED FEE SCHEDULE**

S.L.	UNIT	U/E	OPERATING FUND CONTRIBUTION	CRF FUND CONTRIBUTION	TOTAL MONTHLY FEES DUE
154		61	205.27	20.53	225.80
155		90	302.86	30.29	333.15
156		88	296.14	29.61	325.75
157		121	407.18	40.72	447.90
158		90	302.86	30.29	333.15
159		90	302.86	30.29	333.15
160		120	403.82	40.38	444.20
161		121	407.18	40.72	447.90
162		61	205.27	20.53	225.80
163		90	302.86	30.29	333.15
164		88	296.14	29.61	325.75
165		121	407.18	40.72	447.90
166		90	302.86	30.29	333.15
167		90	302.86	30.29	333.15
168		120	403.82	40.38	444.20
169		121	407.18	40.72	447.90
170		86	289.41	28.94	318.35
171		135	454.30	45.43	499.73
172		137	461.03	46.10	507.13
173		102	343.25	34.32	377.57
174		136	457.66	45.77	503.43
175		106	356.71	35.67	392.38
176		122	410.55	41.06	451.61
177		117	393.73	39.37	433.10
178		117	393.73	39.37	433.10
179		130	437.47	43.75	481.22
180		131	440.84	44.08	484.92
181		117	393.73	39.37	433.10
182		117	393.73	39.37	433.10
183		123	413.92	41.39	455.31
184		123	413.92	41.39	455.31
185		117	393.73	39.37	433.10
186		157	528.34	52.83	581.17
187		131	440.84	44.08	484.92
188		117	393.73	39.37	433.10
189		61	205.27	20.53	225.80
190		90	302.86	30.29	333.15
191		88	296.14	29.61	325.75
192		121	407.18	40.72	447.90
193		90	302.86	30.29	333.15
194		90	302.86	30.29	333.15
195		120	403.82	40.38	444.20
196		121	407.18	40.72	447.90
197		61	205.27	20.53	225.80
198		90	302.86	30.29	333.15
199		88	296.14	29.61	325.75
200		121	407.18	40.72	447.90
201		90	302.86	30.29	333.15
202		90	302.86	30.29	333.15
203		120	403.82	40.38	444.20
204		121	407.18	40.72	447.90

**Mackenzie Village Selkirks and Monashees Phase 1 and 2
PROPOSED FEE SCHEDULE**

S.L.	UNIT	U/E	OPERATING FUND CONTRIBUTION	CRF FUND CONTRIBUTION	TOTAL MONTHLY FEES DUE
TOTAL U/E		21,701	73,027.42	7,302.76	80,330.18
			x 12	x 12	x 12
			876,329.04	87,633.12	963,962.16

EXHIBIT I

PROPOSED FORM OF PURCHASE AGREEMENT- PHASE 1

See attached.

THE SELKIRKS AND MONASHEES AT MACKENZIE VILLAGE
CONTRACT OF PURCHASE AND SALE

"Vendor" 0929468 B.C. Ltd.
Suite 900 - 900 West Hastings Street, Vancouver, B.C., V6C 1E5
Phone: (604) 932-9835 E-mail: david@mackenzievillage.ca

"Purchaser"	
_____	_____
_____	_____
_____	_____
Tel: (H): _____	Tel: (H): _____
Tel: (W): _____	Tel: (W): _____
Tel: (C): _____	Tel: (C): _____
Fax: _____	Fax: _____
E-mail: _____	E-mail: _____
_____	_____
Occupation/Principal Business:	Occupation/Principal Business:
_____	_____
Canadian Citizen/Permanent Resident:	Canadian Citizen/Permanent Resident:
<input type="checkbox"/> Yes / <input type="checkbox"/> No _____	<input type="checkbox"/> Yes / <input type="checkbox"/> No _____
(Country of Citizenship/Residency)	(Country of Citizenship/Residency)
Passport / ID No.	Passport / ID No.
_____	_____
Date of Birth:	Date of Birth:
_____	_____

"Strata Lot" Proposed **Strata Lot** _____ (**Unit No.** _____) in Phase 1 of a development (the "**Development**") known as "The Selkirks and Monashees at Mackenzie Village" to be constructed within a parcel to be subdivided from a portion of the lands (the "**Lands**") located at 1701 Coursier Avenue, Revelstoke, British Columbia and currently legally described as Parcel Identifier: 030-260-833, Lot 2, Section 23, Township 23, Range 2 West of the 6th Meridian, Kootenay District, Plan EPP69441 Except Plan EPP98511.

"Purchase Price" \$ _____ (plus any amount payable for upgrades and other extras). The Purchaser acknowledges and agrees that the Purchase Price is exclusive of applicable taxes (including goods and services tax ("**GST**") or any other federal or provincial sales, service, value added, transition or other tax, as set out in further detail in section 13 of Schedule A)).

1.01 Offer. The Purchaser hereby offers to purchase the Strata Lot from the Vendor for the Purchase Price and upon the terms set forth herein subject to the encumbrances (the "**Permitted Encumbrances**") referred to in the Disclosure Statement (as defined in section 26 of Schedule A). The Purchaser acknowledges that he/she/it is purchasing a strata lot which is to be constructed or is presently under construction.

1.02 Deposit. The Purchaser will pay deposits to Terra Law Corporation, (the "**Vendor's Solicitors**") in trust to be held by them as trustee in accordance with the *Real Estate Development Marketing Act* (British Columbia) ("**REDMA**") as follows:

- a. an initial deposit (the "**First Deposit**") by credit card via Avesdo, certified cheque or bank draft due upon presentation of this offer to the Vendor; \$1,000.00

INITIALS	

- b. a second deposit (the **“Second Deposit”**) equal to 5% of the Purchase Price, less the amount of the First Deposit (for clarity, the combined amount of the First Deposit and the Second Deposit will equal no more than 5% of the Purchase Price), payable by certified cheque or bank draft on or before the date that is 7 days after the Acceptance Date (as defined below); \$ _____
- c. a third deposit (the **“Third Deposit”**) equal to 5% of the Purchase Price, payable by certified cheque or bank draft on or before the date that is the earlier of: (i) 10 days after receipt by the Purchaser of the Building Permit Amendment and the Financing Amendment (each as defined in section 26 of Schedule A hereto); and (ii) 30 days following the Acceptance Date; and \$ _____
- d. a fourth deposit (the **“Fourth Deposit”**) equal to an additional 5% of the Purchase Price, payable by certified cheque or bank draft on or before the date that is the later of: (i) 10 days after receipt by the Purchaser of the Building Permit Amendment and the Financing Amendment (each as defined in section 26 of Schedule A hereto); and (ii) 90 days following the Acceptance Date. \$ _____

The First Deposit, Second Deposit, Third Deposit and Fourth Deposit are collectively referred to herein as the **“Deposit”**.

The Purchaser will pay the balance of the Purchase Price, subject to adjustments described herein, on the Completion Date (as defined in section 1 of Schedule A) by way of certified solicitor’s trust cheque or bank draft.

1.03 Included Items. The Purchase Price includes the following items unless otherwise noted in the Disclosure Statement:

- [a] Oven
- [b] Electric Cook Top
- [c] Dishwasher
- [d] Refrigerator
- [e] Washer and Dryer
- [f] Microwave and Hood Fan
- [g] Electric Hot Water Tank
- [h] Heat Pump or VRV/VRF/split system for heating and cooling (or such other heating and cooling equipment as may be determined by the Developer in its sole discretion)

Fixtures and features as represented in the Disclosure Statement will also be included, provided that the Vendor may substitute materials and brands of reasonably similar or better quality. Presentation Centre / Display Suite decorator features, fixtures, wall treatments, finishings, fittings, mill work, light fixtures and furnishings are not included in the Purchase Price.

The Purchase Price includes the right to the exclusive use of the following number of parking stall(s) and storage locker(s) located within the Development to be allocated in the manner described in the Disclosure Statement: The Vendor reserves the right to determine the location of any parking stall or storage locker allocated to the Purchaser in the Vendor’s sole discretion without consultation with the Purchaser and, if more than one parking stall is to be allocated to the Purchaser, such parking stalls may be allocated by the Vendor to the Purchaser in tandem design. The parking stalls in the Development may vary in size, shape and convenience of location, and may be partially obstructed by equipment and other facilities.

Initial Applicable Box

_____ parking stalls (s)

Purchaser	Purchaser	Vendor
-----------	-----------	--------

_____ storage locker(s)

Purchaser	Purchaser	Vendor
-----------	-----------	--------

1.04 Colour Scheme. The Purchaser selects the following colour scheme for the Strata Lot:

- Forest After Dark **OR** Alpine Sunset

INITIALS	

1.05 Completion, Possession and Adjustment Dates. See Schedule A attached hereto.

1.06 Receipt of Disclosure Statement. The Purchaser acknowledges that the Purchaser has received a copy of the Consolidated Disclosure Statement (as defined in section 26 of Schedule A hereto) for the Development and has been given a reasonable opportunity to read the Consolidated Disclosure Statement prior to entering into this Contract and the execution by the Purchaser of this Contract will constitute a receipt in respect thereof. The Purchaser acknowledges that the information in section 7.2 of the Disclosure Statement regarding this Contract has been drawn to the Purchaser's attention.

INITIALS	

1.07 Electronic Delivery of Disclosure Statement and Amendments. To the extent that the Vendor provided a copy of the Initial Disclosure Statement (as defined in section 26 of Schedule A hereto), the Consolidated Disclosure Statement, or any or all of the amendments to disclosure statement to the Purchaser by electronic means, including, without limitation, by e-mail to the e-mail address set out on page 1 hereof, the Purchaser hereby consents to such delivery by electronic means. The Purchaser hereby acknowledges and agrees that the Vendor may, in its discretion, deliver a copy of any amendment to disclosure statement which is filed in respect of the Disclosure Statement, including, without limitation, the Building Permit Amendment or the Financing Amendment, to the Purchaser by electronic means, including, without limitation, by e-mail to the e-mail address set out on page 1 hereof, and the Purchaser hereby consents to such delivery by electronic means. Any other communication or document to be given by the Vendor will be well and sufficiently given if sent by e-mail to the Purchaser to the e-mail address set out on page 1.

INITIALS	

1.08 Acceptance. The Purchaser's offer herein will be open for acceptance by the Vendor on presentation until 11:59 p.m. the third day after the date of execution of this offer by the Purchaser and upon acceptance by the Vendor signing a copy of this offer, there will be a binding agreement of sale (the "**Contract**") and purchase in respect of the Strata Lot for the Purchase Price, on the terms and subject to the conditions set out herein. The date on which this Contract is duly executed and delivered by each of the Vendor and the Purchaser is referred to herein as the "**Acceptance Date**".

This Contract is dated for reference _____, 202____.

THE TERMS AND CONDITIONS ATTACHED HERETO AS SCHEDULE A ARE PART OF THIS CONTRACT.

THE PURCHASER HAS EXECUTED THIS CONTRACT THIS _____ DAY OF _____, 202____.

WITNESS: _____ PURCHASER(S): _____
(seal)

(seal)

VENDOR'S ACCEPTANCE: The Vendor hereby accepts the Purchaser's offer to purchase contained herein this _____ day of _____ 202____

0929468 B.C. LTD.

By: _____
(Authorized Signatory)

SCHEDULE A

1. Completion Date. The Purchaser will pay the balance of the Purchase Price, as adjusted in accordance with this Contract, by way of a SOLICITOR'S CERTIFIED TRUST CHEQUE or BANK DRAFT by NO LATER THAN 2:00 p.m. on the completion date (the "**Completion Date**"), which will be the date identified by written notice given by the Vendor or the Vendor's Solicitors to the Purchaser or the Purchaser's solicitors/notary (the "**Purchaser's Solicitors**") as a date on which the Strata Lot is or will be ready to be occupied, provided the Vendor or the Vendor's Solicitors will give not less than 10 days' notice thereof. Whether the Strata Lot is ready to be occupied refers to the Strata Lot and not any other strata lot or common property within the Development and the Strata Lot will be deemed to be ready to be occupied on the Completion Date if (i) the City of Revelstoke (the "**City**") has given permission to occupy the Strata Lot, whether such permission is temporary, conditional or final and (ii) the applicable land title office (the "**LTO**") has issued a separate title for the Strata Lot. If the Completion Date is a Saturday, Sunday, statutory holiday or a day upon which the LTO is not open for business, the Completion Date will be the immediate following day on which the LTO is open for business. The notice of the Completion Date given by the Vendor or the Vendor's Solicitors to the Purchaser or the Purchaser's Solicitors may be based on the Vendor's estimate as to when the Strata Lot will be ready to be occupied. If the Strata Lot is not ready to be occupied on the Completion Date so established, then the Vendor may delay the Completion Date from time to time as required, by written notice of such delay to the Purchaser or the Purchaser's Solicitors. If the Completion Date has not occurred by December 31, 2026 (the "**Outside Date**"), then this Contract will terminate on the Outside Date, the Deposit will be returned to the Purchaser and the parties will be released from all of their obligations hereunder, provided that:

- (a) if the Vendor is delayed from completing construction of the Strata Lot as a result of epidemic, pandemic, earthquake, flood or other act of God, fire, explosion, terrorism or accident, howsoever caused, act of any governmental authority, strike, lockout, inability to obtain or delay in obtaining labour, supplies, materials or equipment, delay or failure by carriers or contractors, breakage or other casualty, climactic condition, interference of the Purchaser, or any other event of any nature whatsoever beyond the reasonable control of the Vendor, then the Vendor may, at its option, exercisable by written notice to the Purchaser, in addition to any extension pursuant to subsection 1(b) and whether or not any extension described in subsection 1(b) has been exercised, elect to extend the Outside Date by a period equivalent to such period of delay; and
- (b) the Vendor may, at its option, exercisable by written notice to the Purchaser, in addition to any extension pursuant to subsection 1(a) and whether or not any extension described in subsection 1(a) has been exercised, elect to extend the Outside Date for up to 120 days.

The Purchaser acknowledges that the estimated date range for completion of construction set out in the Disclosure Statement has been provided by the Vendor as a matter of convenience only, is not meant to be legally binding upon the Vendor and that the actual Completion Date will be established in the manner set out above.

2. Conveyance. The Purchaser will cause the Purchaser's Solicitors to prepare and deliver to the Vendor's Solicitors at least five days prior to the Completion Date a statement of adjustments and a Freehold Transfer (the "**Transfer**") for the Strata Lot. The Vendor will execute and deliver, or cause to be executed and delivered, the Transfer and the statement of adjustments to the Purchaser's Solicitors on or before the Completion Date on the condition that, forthwith upon the Purchaser's Solicitors obtaining a post registration index search from the LTO indicating that, in the ordinary course of LTO procedure, the Purchaser will become the registered owner of the Strata Lot (subject only to the Permitted Encumbrances and charges for which the Purchaser is responsible), the Purchaser will cause payment of the adjusted balance of the Purchase Price due on the Completion Date to be made by the Purchaser's Solicitors to the Vendor's Solicitors. The transfer of the Strata Lot will also be subject to the Vendor's financing arranged in connection with the Development or any builders' lien claims provided that the Vendor's Solicitors undertake to clear title to the Strata Lot of all encumbrances related to such financing and such builders' liens claims within a reasonable period of time after receiving the balance of the Purchase Price due on the Completion Date. The Purchaser acknowledges that the Vendor's financing may remain as a charge against the common property of the Development until the Vendor has completed the sale of the balance of the strata lots in the Development whereupon the Vendor covenants such financing will be discharged entirely.

If the Purchaser is relying upon a new mortgage to finance the Purchase Price, the Purchaser, while still required to pay the Purchase Price on the Completion Date, may wait to pay the Purchase Price to the Vendor until after the Transfer and new mortgage documents have been lodged for registration in the LTO, but only if, before such lodging, the Purchaser has: (a) made available for tender to the Vendor that portion of the Purchase Price not secured by the new mortgage; and (b) fulfilled all the new mortgagee's conditions for funding except lodging the mortgage for registration; and (c) made available to the Vendor a solicitor's or notary's undertaking to pay the Purchase Price upon the lodging of the Transfer and new mortgage documents and the advance by the mortgagee of the mortgage proceeds.

INITIALS	

3. Deposit. The Deposit will be dealt with as follows:

- (a) The Deposit, or any portion thereof, when received, will be deposited by the Vendor's Solicitors in an interest bearing trust account with the interest to accrue to the benefit of the Vendor.
- (b) The Vendor and the Purchaser agree that the total amount of the Deposit (including all portions thereof, whether paid or unpaid) together with interest thereon constitutes a genuine pre-estimate of the damages the Vendor will suffer as a result of the Purchaser's failure to pay any portion of the Deposit when required hereunder or failure to complete the purchase of the Strata Lot in default of its obligations hereunder. If the Purchaser fails to pay any portion of the Deposit when required hereunder or fails to complete the purchase of the Strata Lot in default of his/her/its/their obligations hereunder, then subject to section 7(b) of this Schedule A, the Vendor may elect to terminate this Contract and, in such event, the portion of the Deposit that has been paid together with interest thereon will be absolutely forfeited to the Vendor as liquidated damages, without prejudice to any other remedy which the Vendor may have in respect of the Purchaser's default including, without limitation, the right of the Vendor to pursue the Purchaser for any unpaid balance of the Deposit and to seek additional damages.
- (c) If the Vendor fails to complete the sale of the Strata Lot, then the Deposit paid will be paid to the Purchaser, together with any interest earned thereon, as the Purchaser's sole and exclusive remedy in accordance with section 8.

The Purchaser acknowledges that any payment made by the Purchaser that is returned for non-sufficient funds will be subject to a service charge equal to the amount charged by the applicable financial institution. The Purchaser acknowledges that the Vendor may appoint replacement solicitors for the Vendor's Solicitors and/or cause the Deposit paid and subsequent payments on account of the Deposit to be transferred to the trust account of such replacement solicitors or another trustee (as defined in REDMA), in either case upon written notice to the Purchaser.

Notwithstanding the foregoing, the Purchaser acknowledges and agrees that, in accordance with Section 19 of REDMA, the Vendor may enter into a deposit protection contract (the "**Deposit Protection Contract**") with an approved insurer, pursuant to which the deposits paid by purchasers of strata lots in the Development, including the Deposit, are insured and, as such, may be released by the Vendor's Solicitors, in whole or in part, to the Vendor and the Vendor may use such deposits for purposes related to the Development, including without limitation, the construction and marketing of the Development in accordance with the provisions of REDMA. Upon the release of the Deposit or any portion thereof to the Vendor in accordance with the Deposit Protection Contract, the provisions of this Contract will be deemed to have been amended accordingly. The Purchaser acknowledges that from and after the release of the Deposit or any portion thereof pursuant to a Deposit Protection Contract, no further interest will be earned on the amount so released.

4. Possession, Risk and Adjustment. The Purchaser will assume all taxes, rates, local improvement assessments, water rates and scavenging rates, assessments of the strata corporation (the "**Strata Corporation**") of which the Strata Lot forms a part, and all other adjustments both incoming and outgoing of whatever nature in respect of the Strata Lot, including an adjustment to credit the Vendor with the Purchaser's share of the prepaid insurance premium for the Strata Corporation, will be made as of the Completion Date. The Strata Lot will be at the risk of the Vendor to and including the day preceding the Completion Date, and thereafter at the risk of the Purchaser. So long as the Purchase Price and all other amounts payable by the Purchaser to the Vendor in respect of the Strata Lot have been paid in full, the Purchaser may have possession of the Strata Lot on the day following the Completion Date (the "**Possession Date**").

The Purchaser is responsible for all utility charges as of the Possession Date and must ensure that he/she/it notifies the necessary utility companies to have the utilities transferred into his/her/its/their name on the Possession Date. In the event the Purchaser does not transfer the utilities into his/her/its/their name as of the Possession Date, any charges to the Vendor that should be the Purchaser's responsibility will be paid to the Vendor in full within five Business Days (as defined in section 28 of this Schedule A) after notification thereof from the Vendor. If said amount is not paid within the five Business Day period, then an initial charge of \$50.00, plus a further charge of \$50.00 each month thereafter, will be applied to the outstanding amount until such amount and such charges are paid in full by the Purchaser.

5. Builders' Lien Holdback. That portion, if any, of the balance of the Purchase Price required by law to be held back by the Purchaser in respect of builders' lien claims (the "**Lien Holdback**") will be paid to the Vendor's Solicitors on the Completion Date. The Lien Holdback will be held in trust for the Purchaser pursuant to the *Strata Property Act* (British Columbia) and *Builders Lien Act* (British Columbia) (or successor statutes) solely in respect of lien claims registered in

INITIALS	

the LTO in connection with work done at the behest of the Vendor. The Vendor's Solicitors are authorized to invest the Lien Holdback in an interest bearing trust account and to pay to the Vendor (or as directed by the Vendor), on the earlier of (i) the date on which the time for filing a claim of lien under the *Builders Lien Act* (British Columbia) expires; and (ii) the date which is 55 days after the date that the balance of the Purchase Price becomes due as aforesaid, the Lien Holdback plus interest, if any, accrued thereon, less the amount of any builders' lien claim filed against the Strata Lot of which the Purchaser or the Purchaser's Solicitors notify the Vendor's Solicitors in writing by 1:00 p.m. on that day. The Purchaser hereby authorizes the Vendor and the Vendor's Solicitors to do all things necessary to discharge any builders' liens, including bringing court proceedings in the name of the Purchaser, provided that any such proceedings will be at the sole expense of the Vendor.

6. Vendor's Condition Precedent. The obligation of the Vendor to complete the sale of the Strata Lot is subject to the Vendor obtaining construction financing in respect of Phase 1 that is satisfactory to the Vendor in its sole, absolute and unfettered discretion on or before December 19, 2023.

The foregoing condition is for the exclusive benefit of the Vendor and may be waived by the Vendor at any time on or prior to the time set forth for satisfaction of the same. The condition will be deemed to have been waived within the time set forth if the Purchaser has not received, within seven (7) days following the date on which such condition is to be satisfied, notification from the Vendor that such condition has not been satisfied or waived. In the event the Vendor provides notice within such seven (7) day period that such condition is not waived or satisfied, this Contract will be terminated, whereupon the Deposit will be forthwith returned to the Purchaser without deduction, and this Contract will thereupon be null and void, and of no further force or effect, and the Vendor will not be liable for any costs or damages suffered by the Purchaser as a result of or in connection with this Contract or as a direct or indirect result of its termination. In consideration of the amount of \$1.00 now paid by the Vendor to the Purchaser, the receipt and sufficiency of which is hereby acknowledged by the Purchaser, this Contract is irrevocable by the Purchaser notwithstanding the foregoing condition precedent.

7. Time is of The Essence/Purchaser Default. Time will be of the essence hereof. If the Purchaser fails to make any payment on account of the Purchase Price (including, without limitation, any portion of the Deposit or the balance of the Purchase Price), together with adjustments thereto as provided herein, when due or fails to pay any other amount payable hereunder when due, then the Vendor may, at its option:

- (a) terminate this Contract by written notice to the Purchaser and, in such event, the portion of the Deposit that has been paid and all interest accrued thereon will be absolutely forfeited to the Vendor as liquidated damages, the parties agreeing that the total amount of the Deposit (including all portions thereof, whether paid or unpaid) together with interest thereon constitutes a genuine pre-estimate of the damages the Vendor will suffer as a result of the Purchaser's failure to pay, when due, any payment on account of the Purchase Price, together with adjustments thereto as provided herein, or any other amounts payable hereunder, without prejudice to the Vendor's other remedies including, without limitation, the right of the Vendor to pursue the Purchaser for any unpaid balance of the Deposit and to seek additional damages and, subject to the provisions of REDMA, the Vendor's Solicitors are hereby irrevocably authorized and directed by the Purchaser to pay the amount held by them and such interest as may have accrued thereon to the Vendor upon written demand therefor by the Vendor; or
- (b) elect to extend the date for payment or the Completion Date, as applicable, to a certain date determined by the Vendor, time to remain of the essence hereof and subject to the Vendor's right in its sole discretion, to grant further extensions to a certain date each time, in which event the Purchaser will pay to the Vendor, in addition to the Purchase Price, interest on the unpaid portion of the Purchase Price and other unpaid amounts payable hereunder at the rate of 2% per month (26.82% per annum), calculated daily and compounded monthly not in advance, from the date upon which such portion and amounts were due to the date upon which such portion and amounts are paid.

The Vendor may cancel this Contract pursuant to subsection 7(a) of this Schedule A or grant one or more further extensions pursuant to subsection 7(b) of this Schedule A, at any time after extending the date for payment or the Completion Date, as the case may be, pursuant to subsection 7(b) of this Schedule A if the Purchaser fails to make such payment or complete the purchase of the Strata Lot, as the case may be, in accordance with this Contract on or before such extended date.

8. Vendor's Default. Notwithstanding anything else contained herein, the Purchaser acknowledges and agrees that any and all claims, whether in contract or tort, which the Purchaser has or hereafter may have against the Vendor in any way arising out of, or related to, the Strata Lot or the Vendor's obligations and covenants pursuant to this Contract will be limited to the amount paid by the Purchaser on account of the Deposit. The Purchaser acknowledges and agrees

INITIALS	

that if the Vendor fails to complete the sale of the Strata Lot in default of its obligations hereunder, then the Deposit will be repaid to the Purchaser as liquidated damages as the Purchaser's sole and exclusive remedy and the Purchaser will have no further claims whatsoever against the Vendor in respect of such default and the Vendor will have no further obligations or liabilities whatsoever hereunder, and the Purchaser hereby releases and discharges the Vendor from any claim beyond the amount of the Deposit. The Purchaser acknowledges and agrees that the Vendor will not be liable for any damages or costs whatsoever beyond the amount of the Deposit which may be incurred by the Purchaser resulting from any such failure including, without limiting the generality of the foregoing, relocation costs, professional fees and disbursements, opportunity costs, loss of bargain, damages and/or costs resulting from hardship or any other damages or costs incurred by the Purchaser, directly or indirectly, as a result of the Vendor's default.

9. **Entire Contract/Representations.** The Purchaser acknowledges and agrees that this Contract constitutes the entire agreement between the parties with respect to the sale and purchase of the Strata Lot and supersedes any prior agreements, negotiations or discussions, whether oral or written, of the Vendor and the Purchaser, and that there are no representations, warranties, conditions or collateral contracts, expressed or implied, statutory or otherwise, or applicable hereto, made by the Vendor, its agents or employees, or any other person on behalf of the Vendor, including, without limitation, arising out of any sales brochures, models, websites, social media, blogs, Twitter, Facebook, representative view sets, showroom displays, photographs, illustrations or renderings or other marketing materials provided to the Purchaser or made available for his/her/its/their viewing other than those contained herein and in the Disclosure Statement. In particular, the Purchaser acknowledges and agrees that the materials, specifications, details, dimensions and floor plans set out in any materials viewed by the Purchaser are approximate and subject to change without notice in order to comply with building site conditions and municipal, structural and Vendor and/or architectural requirements.

10. **Construction.**

(a) The Vendor will cause the Strata Lot to be constructed and completed in a good and workmanlike manner substantially in accordance with the plans and specifications (the "**Plans and Specifications**") for the Development prepared by the Vendor's architect(s) for the Development (the "**Architect**") subject to any changes required by the City. The Vendor may make alterations to the features, design and layout of the Strata Lot which are desirable in the reasonable discretion of the Vendor and may use materials other than as prescribed in the Plans and Specifications if they are reasonably similar to what is prescribed. The Vendor reserves the right to alter the common property of the Development at any time and from time to time if, in its sole opinion, such alteration or alterations improve the structural integrity of the Development, its mechanical systems, its ability to withstand water penetration or aesthetics. The Purchaser is aware that the preliminary strata plan (the "**Preliminary Plan**") for the phase of the Development in which the Strata Lot is located, a copy of which Preliminary Plan is attached to the Disclosure Statement in Exhibit A, is based on architectural drawings and measurements. The actual size, dimensions and/or configuration of the Strata Lot including any balcony, patio or deck, as set forth in the final strata plan (the "**Final Strata Plan**") for the phase of the Development in which the Strata Lot is located may vary from what is depicted on the Preliminary Plan. The areas and dimensions of the strata lots (including the Strata Lot) in the Development set out in the marketing materials referred to in section 9 of this Schedule A, including balconies, patios and decks, are approximate, based on architectural drawings and provided for reference purposes only, and are not represented as being the actual final areas and dimensions. The Vendor represents and warrants that the actual area of the Strata Lot, as set forth in the Final Strata Plan, will be no more than 3% smaller than indicated in the Disclosure Statement when both measurements are calculated in accordance with the *Strata Property Act* (British Columbia). If the Strata Lot is more than 3% smaller, then the Purchase Price will be reduced by a percentage equal to the number of percent (rounded to the nearest one-hundredth of a percentage point) by which the Strata Lot is more than 3% smaller and for greater certainty, the foregoing will be the Purchaser's sole remedy in respect thereof.

(b) The Purchaser acknowledges that the Development will include service facilities and equipment required in connection therewith such as transformers, fire hydrants, vents, ducts, fans and other such facilities and equipment (the "**Service Facilities**"). The Service Facilities will be located within the Development as required by the City or recommended by the Vendor's consultants. The Purchaser acknowledges that the current plans for the Development may not indicate the location of all the Service Facilities and that the Vendor reserves the right to relocate, add or delete all or a portion of the Service Facilities as deemed necessary by the Vendor, without compensation to the Purchaser.

(c) The Purchaser will make the selection of colour scheme, materials and optional items (to the extent the Vendor permits such selection to be made) and pay any additional costs therefor, promptly when requested to do so by the Vendor. If the Purchaser fails to do so, the Vendor may make any such selection and the Purchaser will be bound thereby and will pay any additional costs associated with such selection.

INITIALS	

- (d) Due to the natural variation of colour and texture in any wood, stone, granite, and dye lots of any tile, carpet and other components of the Strata Lot and the fact that the colour of natural products (especially wood) will change over time, the finishes of any wood, granite, tile, stone, carpet and other components of the Strata Lot may differ from the colour, grain, vein, pattern, size, stain resistance and textures shown in the display unit or any samples provided to or viewed by the Purchaser. In addition, even within the Strata Lot, the textures, colours and finishes may vary for the same reasons. The variations are inherent characteristics which cannot be fully controlled and any such variations will not in any event be considered or deemed to be deficiencies in the Strata Lot.
- (e) The Purchaser acknowledges and agrees that the ceiling heights of all strata lots in the Development may vary from floor to floor and may have areas of the ceilings dropped down from the typical height of the ceilings in order to accommodate construction requirements including, but not limited to, mechanical, electrical equipment, ducting, ventilation systems, plumbing and structural requirements.

11. Purchaser Acknowledgements. The Purchaser acknowledges and agrees that:

- (a) the Deposit payment (or portion thereof) that is paid will not begin to bear interest until after it is deposited into the Vendor's Solicitors' trust account which may, in the Vendor's discretion, be after the expiry of all statutory rescission periods;
- (b) the municipal address(es) of the Development, the suite and strata lot number assigned to the Strata Lot and the number assigned to the floor in the Development on which the Strata Lot is located are subject to change as determined by the Vendor or the City;
- (c) the Completion Date may be any day up to and including the Outside Date, as extended pursuant to subsection 1(a) and 1(b) of this Schedule A and the Purchaser releases the Vendor and its affiliates from any actions, causes of action, costs, claims, demands and liabilities arising as a result of the date on which the Completion Date occurs;
- (d) in the event of any discrepancy between the strata lot number and suite number set out on page 1 of this Contract, the Strata Lot is the strata lot labelled on the Preliminary Plan with the strata lot number set out on page 1 of this Contract, as the same may change as contemplated in subsection 11(b);
- (e) the parking stalls and storage lockers in the Development, including any parking stall(s) and storage locker(s) to which the Purchaser is entitled hereunder, if any, will vary in size, shape and convenience of location, and the parking stalls and storage lockers in the Development, including any parking stall(s) and storage locker(s) to which the Purchaser is entitled hereunder, if any, may be partially obstructed by columns, pipes, ducts, mechanical equipment, electrical equipment and other facilities, and the Purchaser will accept any parking stall(s) and storage locker(s) to which the Purchaser is entitled hereunder, if any, on an "as is, where is" basis and will have no claim against the Vendor in respect of any variation in the size, shape or convenience of location of such parking stall(s) and / or storage locker(s) or any partial obstruction of such parking stall(s) and / or storage locker(s);
- (f) the Strata Lot forms a part of a phased development and the Purchaser understands and accepts that the Purchaser may be inconvenienced by ongoing construction activities relating to other phase(s) of the Development which may, from time to time, result in noise, vibrations, odours, dirt, dust and such other irritants that are associated with construction projects similar to the Development; and
- (g) it has read and understood the summary of the legal notations, covenants, easements, statutory rights of way and other encumbrances that are described in subsections 4.3 and 4.4 of the Disclosure Statement.

12. Inspection. The Vendor warrants that, on the Completion Date, the Strata Lot and the common property in completed phases of the Development will be registered under a third-party new home warranty provider. The Purchaser or his/her/its/their representative will have the right to inspect the Strata Lot with a representative of the Vendor at a reasonable time designated by the Vendor by written notice or by telephone prior to the Completion Date and a refusal or failure by the Purchaser to inspect the Strata Lot at such time will be deemed to be a waiver and forfeiture of such right, in which case the Purchaser will be deemed to be satisfied with and to have accepted the physical condition of the Strata Lot (including the existing kitchen, bathrooms and other installations, equipment, appliances and furnishings in the Strata Lot) on the Completion Date. At the conclusion of such inspection, the Vendor will prepare a conclusive list of any defects or deficiencies (the "Deficiencies") which are to be rectified by the Vendor. The parties will sign the list and the Purchaser will be deemed to be satisfied with and to have accepted the physical condition of the Strata Lot

INITIALS	

(including the existing kitchen, bathrooms and other installations, equipment, appliances and furnishings) subject only to the Deficiencies. If the Purchaser does not sign the Deficiencies list, the Purchaser will be deemed to be satisfied with and to have accepted the physical condition of the Strata Lot (including the existing kitchen, bathroom and other installations, equipment, appliances and furnishings). The Purchaser covenants and agrees to complete the purchase of the Strata Lot on the Completion Date on the terms and conditions herein contained notwithstanding that the Deficiencies may be rectified subsequent to the Completion Date. The Purchaser will not be allowed to have access to the Strata Lot except for this inspection prior to the Possession Date. No holdback will be made on closing in respect of the Deficiencies or other deficiencies. In the event of a disagreement between the Purchaser and the Vendor as to what constitutes a defect or deficiency, or whether or not a defect or deficiency has been rectified, the decision of the Architect or any replacement therefor appointed by the Vendor will be conclusive, final and binding on the parties. Following the Completion Date, the Purchaser agrees to provide the Vendor and its representatives, contractors and agents with access to the Strata Lot at all reasonable times on 24 hours' notice from the Vendor in order for the Vendor or its representatives, contractors or agents to rectify any outstanding Deficiencies, and the Purchaser will in no manner interfere with or impede any such person while he or she is carrying out such work.

- 13. Costs/Sales and Transfer Taxes.** The Purchaser will pay all taxes and costs in connection with the sale and purchase of the Strata Lot (including property transfer tax, any additional property transfer tax payable if the Purchaser is a foreign entity, a taxable trustee or both and any GST or any other federal or provincial sales, service, value added, transition or other tax required to be paid by the Purchaser in connection with the purchase and sale of the Strata Lot and the equipment and appliances included with the Strata Lot), other than the costs of the Vendor incurred in clearing title to the Strata Lot. Without limiting the generality of the foregoing, the Purchaser agrees that the Purchase Price does not include any applicable taxes (including GST or any other federal or provincial sales, service, value added, transition or other tax) that may be applicable to the sale of the Strata Lot (and any equipment and appliances included with it) hereunder whether levied against the Purchaser or the Vendor, all of which will be payable by the Purchaser on the Completion Date in addition to the Purchase Price.

If and to the extent required under Part IX of the *Excise Tax Act* (Canada), and subject to the foregoing, the Purchaser will remit to the Vendor on the Completion Date any GST that may be exigible under Part IX of the *Excise Tax Act* (Canada) in respect of the transaction contemplated herein, and the Vendor agrees that it will remit or otherwise account for such funds to Canada Revenue Agency ("**CRA**") in accordance with its obligations under Part IX of the *Excise Tax Act* (Canada) and the foregoing. Notwithstanding the foregoing, if the Purchaser is a corporation, trust or partnership which is registered for GST purposes and, on or before the Completion Date, the Purchaser provides the Vendor with a certificate as to the GST registered status of the Purchaser containing the Purchaser's GST registration number, the Purchaser will not be required to pay the GST to the Vendor but will be liable for, will self-assess and will remit same directly to CRA. The Purchaser will indemnify and save harmless the Vendor from and against any and all GST, penalties, costs and/or interest which may become payable by or assessed against the Vendor as a result of any failure by the Purchaser to comply with the foregoing and such indemnity will survive and not merge upon closing of the sale of the Strata Lot contemplated herein. The Purchaser acknowledges that the Vendor will have no obligation to adjust the Purchase Price to credit the Purchaser for any new housing rebate to which the Purchaser might be entitled.

14. Requirements under REDMA respecting Assignments.

- (a) In accordance with section 20.3(1) of REDMA and section 10.2(1) of the *Real Estate Development Marketing Regulation*, B.C. Reg. 505/2004 (the "**REDMA Regulation**"), the Vendor and the Purchaser agree as follows:
- (i) Without the Vendor's prior consent, any assignment of this Contract is prohibited.
 - (ii) An assignment under REDMA is a transfer of some or all of the rights, obligations and benefits under a purchase agreement made in respect of a strata lot in a development property, whether the transfer is made by the purchaser under the purchase agreement to another person or is a subsequent transfer.
 - (iii) Each proposed party to an assignment agreement must provide the Vendor with the information and records required under REDMA.
- (b) Pursuant to section 20.3(1) of REDMA and section 10.2(2) of the REDMA Regulation, the Vendor hereby gives notice to the Purchaser of the following:

INITIALS	

- (i) Before the Vendor consents to the assignment of this Contract, the Vendor will be required to collect information and records under REDMA from each proposed party to an assignment agreement, including personal information, respecting the following:
 - A. the party's identity;
 - B. the party's contact and business information; and
 - C. the terms of the assignment agreement.
- (ii) Information and records collected by the Vendor must be reported by the Vendor to the administrator designated under the *Property Transfer Tax Act*. The information and records may only be used or disclosed for tax purposes and other purposes authorized by section 20.5 of REDMA, which includes disclosure to the Canada Revenue Agency.
- (c) Without limiting anything set out in subsections 14(a) or 14(b), prior to the Vendor consenting to any assignment of this Contract, the Purchaser will cause each proposed party to an assignment agreement to give to the Vendor all information and records prescribed pursuant to section 20.3(2) of REDMA and/or section 10.3 of the REDMA Regulation (collectively, the "**Prescribed Information and Records**").
- (d) If the Vendor consents to any assignment of this Contract, the Purchaser will cause the parties to the assignment agreement to forthwith deliver to the Vendor a copy of the written and signed assignment agreement, and the Purchaser acknowledges and agrees that the Vendor may keep and use such copy of the assignment agreement for such purposes as may be required or permitted under REDMA or the REDMA Regulation.
- (e) The Purchaser acknowledges and agrees that the Vendor may, at any time and from time to time, (i) file the Prescribed Information and Records, as well as any other information and records regarding the Purchaser, any assignee or proposed assignee of this Contract and/or any assignment or proposed assignment of this Contract, with the administrator designated under the *Property Transfer Tax Act* and (ii) disclose the Prescribed Information and Records and such other information and records to such persons as may otherwise be required by law.
- (f) Forthwith upon the request of the Vendor, the Purchaser will provide, and will cause any assignee or proposed assignee of this Contract to provide, such other information and records as the Vendor may require or desire in connection with any assignment or proposed assignment of this Contract, including information regarding the Purchaser, the assignee or proposed assignee and/or the assignment or proposed assignment of this Contract. The Purchaser acknowledges that REDMA may be amended from time to time to modify the obligations and requirements, or to impose additional obligations and requirements, of the Vendor and/or the Purchaser with respect to assignments of purchase contracts, and the Purchaser covenants and agrees to comply with all such obligations and requirements and to cooperate with the Vendor and promptly comply with all requests of the Vendor in relation to such obligations and requirements.
- (g) For greater certainty, and notwithstanding anything else in this section 14 the notices, terms and conditions in this section 14 do not: (i) constitute consent by the Vendor to any assignment of this Contract; (ii) obligate the Vendor to consent to any assignment of this Contract; or (iii) derogate from, diminish, limit, amend or affect the Vendor's right to arbitrarily withhold its consent to any assignment of this Contract in the Vendor's sole and unfettered discretion pursuant to section 15 of this Contract. Accordingly, the Purchaser should not enter into this Contract with any expectation of, on reliance upon, the Purchaser's ability to assign this Contract in the future.

15. Assignment.

- (a) The Purchaser will not assign its interest in the Strata Lot or in this Contract without the prior written consent of the Vendor, which consent may be arbitrarily withheld in the Vendor's sole and unfettered discretion, and, without limiting the foregoing, the Vendor may withhold its consent in accordance with section 14 above. Unless the Vendor so consents, the Vendor is not required to convey the Strata Lot to anyone other than the Purchaser named in this Contract. Any consent permitted hereunder will be in the form of consent provided by the Vendor and will contain such terms and conditions as may be required by the Vendor in its sole discretion.

INITIALS	

- (b) The Purchaser will not, at any time before the Completion Date, advertise or solicit offers from the public with respect to the assignment of this Contract or the resale of the Strata Lot by the Purchaser without the prior written consent of the Vendor, which consent may be arbitrarily withheld in the Vendor's sole and unfettered discretion, and in particular, the Purchaser will not list the Strata lot or the Purchaser's interest in this Contract on any Multiple Listing Service (MLS). For greater certainty, if the Developer consents to the Purchaser advertising or soliciting offers from the public with respect to the assignment of this Contract or the resale of the Strata Lot by the Purchaser:
 - (i) such consent will be in the form of consent provided by the Vendor and will contain such terms and conditions as may be required by the Vendor in its sole discretion; and
 - (ii) such consent will not in any event be interpreted or construed as the Developer consenting to the assignment of the Contract by the Purchaser (which consent, for greater certainty, may be arbitrarily withheld by the Vendor in the Vendor's sole and unfettered discretion pursuant to subsection 15(a)).
- (c) As a condition for agreeing to an assignment of the Purchaser's interest in the Strata Lot or in this Contract and for any associated legal and administrative costs, the Vendor may, at its sole option, charge the Purchaser an administration fee equal to 2% of the aggregate of:
 - (i) an amount equal to any consideration paid by the assignee to the Purchaser in relation to the assignment plus applicable taxes thereon; and
 - (ii) the Purchase Price plus applicable taxes thereon.
- (d) Notwithstanding paragraph 15(c)(i) and 15(c)(ii), the Vendor will charge the Purchaser a flat fee of \$350.00 plus applicable taxes thereon if the assignee is the Purchaser's spouse, parent, child, grandparent, grandchild or sibling or a company controlled by the Purchaser. Following any assignment, the assignor will not be relieved of its obligations under this Contract but will continue to remain liable to perform all obligations of the Purchaser under this Contract.

16. Continuing Construction and Marketing. The Purchaser agrees that the Vendor may continue to carry out construction work on the Development after the completion of the purchase of the Strata Lot by the Purchaser, including, without limitation, construction of future phase(s), if any. The Purchaser acknowledges and accepts that such work may cause inconvenience to the use and enjoyment of the Strata Lot. The Purchaser will not impede or interfere with the Vendor's completion of construction of other strata lots, the common property or the Development. The Purchaser acknowledges that the Vendor may retain strata lots in the Development for use as sales and administrative offices and/or display suites for marketing purposes or otherwise to market the Development. The Purchaser agrees that for so long as the Vendor is the owner of any strata lots in the Development, the Vendor may carry out marketing, promotional and sales activities within the common property (including parking stalls and recreational facilities) of the Development or strata lots owned or leased by the Vendor, including, without limitation, maintaining display suites, other display areas, parking areas and signage (including signage on the exterior of the Development) and permitting public access to same for the purpose of marketing any unsold strata lots in the Development. In addition, the Vendor may conduct tours of the Development from time to time with prospective purchasers and hold events and other activities within the Development in connection with the marketing and sales activities for the Development.

17. Proxies. The Purchaser covenants and agree to, on or before the Completion Date and from time to time thereafter as the Developer may request, grant proxies to the Developer or to such other entities as the Developer may direct, in such form and containing such terms and conditions as the Developer may determine, in its sole discretion, permitting the Developer or such other entities to exercise the Purchaser's vote in the Strata Corporation, to, among other things, amend any strata plan(s) filed in the LTO in respect of the Development or any phase thereof or designate certain areas on such strata plans as limited common property for the exclusive use of one or more strata lots in the Development, and the Purchaser further covenants and agrees not to revoke such proxies. The Purchaser's covenants and obligations contained in this section 17 will survive and not merge upon the completion of the purchase and sale of the Strata Lot contemplated herein.

18. Successors and Assigns. This Contract will enure to the benefit of and be binding upon the parties hereto and their respective successors, permitted assigns, heirs, administrators and executors.

INITIALS	

- 19. Governing Law.** This Purchaser's offer herein and the Contract which results from its acceptance will be exclusively governed by and construed in accordance with the laws of the Province of British Columbia and the parties agree to attorn to the exclusive jurisdiction of the courts of the Province of British Columbia.
- 20. Contractual Rights.** This offer and the Contract which results from its acceptance creates contractual rights only and not any interest in land and the Purchaser will not be entitled to register this Contract or any interest arising under this Contract against the Strata Lot or the Lands. The Purchaser will acquire an interest in land upon completion of the purchase and sale contemplated herein.
- 21. Personal Information.** The Purchaser hereby consents to the collection, use and disclosure of personal information contained in this Contract and otherwise collected by or on behalf of the Vendor and its agents, affiliates and service providers for the following purposes:
- (a) to complete the transaction contemplated by this Contract;
 - (b) to secure financing in respect of the construction of the Development;
 - (c) to invest the Deposit as provided for herein including providing personal information to the financial institution as required for reporting interest earned on the Deposit in accordance with applicable laws;
 - (d) to facilitate the entering into of a Deposit Protection Contract with respect to the Deposit and release of the Deposit in accordance therewith;
 - (e) to facilitate the completion and management of the Development including the transfer of management of the Development to a property manager;
 - (f) to market, sell, provide and inform the Purchaser of products and services of the Vendor and its affiliates and partners, including information about future projects;
 - (g) for any or all of the following purposes: to comply with any and all applicable laws and regulations (including, without limitation, the *Proceeds of Crime (Money Laundering) and Terrorist Financing Act* (Canada) and regulations, rules and policies thereunder or relating thereto and REDMA and all regulations thereto); to comply with applicable legal or regulatory obligations, including as part of a judicial proceeding; in response to a subpoena, warrant, court order or other legal process; or as part of an investigation or request, whether formal or informal, from law enforcement or a government official;
 - (h) to disclose such personal information to the Vendor' affiliates, agents, assignees, partners, business partners, contractors and suppliers, bankers, lawyers, accountants, insurers, warranty providers, utility providers, relevant governmental authorities or agencies (including the LTO and the CRA) and other advisors and consultants in furtherance of any of the foregoing purposes;
 - (i) to comply with the *Freedom of Information and Privacy Act* (British Columbia) and regulations, rules and policies thereunder or relating thereto;
 - (j) if the Strata Lot is listed on a Multiple Listing Service®, for the purpose of the compilation, retention and publication by the real estate board that operates the Multiple Listing Service® and other real estate boards of any statistics including historical Multiple Listing Service® data for use by persons authorized to use the Multiple Listing Service® of that real estate board and other real estate boards;
 - (k) for enforcing codes of professional conduct and ethics for members of real estate boards;
 - (l) for the purpose (and to the recipients) described in the brochure published by the British Columbia Real Estate Association entitled Working with A Realtor®; and
 - (m) to comply with the Vendor's legal reporting requirements in respect of assignments and proposed assignments.

The Purchaser covenants and agrees to provide, and cause any third parties to provide, to the Vendor, the Vendor's agents and the Vendor's Solicitors, promptly upon request, any additional personal or other information not contained

INITIALS	

herein that is required in order to comply with the *Proceeds of Crime (Money Laundering) and Terrorist Financing Act* (Canada) and regulations, rules and policies thereunder or relating thereto, and the Purchaser acknowledges that the foregoing consent applies to any such personal information.

- 22. **Vendor's Right to Terminate.** The Vendor may in its sole discretion terminate this Contract if the Vendor has reasonable grounds to suspect that any part of the transaction contemplated by this Contract is related to the commission or attempted commission of a "money laundering offence" or a "terrorist activity financing offence", as defined in the *Proceeds of Crime (Money Laundering) and Terrorist Financing Act* (Canada) and regulations under that Act, as amended from time to time, in which event the portion of the Deposit that has been paid will be returned to the Purchaser and the Purchaser will have no further claims against the Vendor.
- 23. **Notices and Tender.** Any notice to be given to the Purchaser hereunder will be sufficiently given (a) if deposited in any postal receptacle in Canada addressed to the Purchaser at the Purchaser's address or the Purchaser's Solicitors at their offices and sent by regular mail, postage prepaid, or (b) if delivered by hand or if transmitted by facsimile or e-mail to the Purchaser's Solicitors at their office or to the Purchaser. Such notice will be deemed to have been received if so delivered or transmitted, when delivered or transmitted and if mailed, on the second Business Day after such mailing. The address, fax number (if any) and e-mail address (if any) for the Purchaser will be as set out above or such other address, fax number or e-mail address of which the Purchaser has last notified the Vendor in writing. Any documents to be tendered on the Purchaser may be tendered on the Purchaser or the Purchaser's Solicitors. Any notice to be given to the Vendor may be given to the Vendor or the Vendor's Solicitors in the same manner, and will be deemed to have been received, as provided for in the preceding provisions of this section, all other matters remaining the same except as altered where necessary. Any documents or money to be tendered on the Vendor or the Vendor's Solicitors will be tendered by way of certified funds or bank draft and will be delivered at the Purchaser's expense to the Vendor or the Vendor's Solicitors.
- 24. **Purchaser Comprising More Than One Party.** If the Purchaser consists of more than one party, then the obligations of the Purchaser hereunder will be the joint and several obligations of each party comprising the Purchaser and any notice given to one of such parties will be deemed to have been given at the same time to both or all of such parties comprising the Purchaser.
- 25. **Change of Address.** The Purchaser covenants and agrees to promptly notify the Vendor in writing of any change in the Purchaser's address, e-mail address, phone number and/or fax number.
- 26. **Disclosure Statement.**
 - (a) In this Contract:
 - (i) "Initial Disclosure Statement" means the initial disclosure statement dated December 19, 2022, filed with the Superintendent of Real Estate with respect to the Development;
 - (ii) "Disclosure Statement" means, collectively, the Initial Disclosure Statement together with and as amended by the amendment to disclosure statement dated August 30, 2023 and any and all amendments to disclosure statement filed from time to time with respect to the Initial Disclosure Statement; and
 - (iii) "Consolidated Disclosure Statement" means the consolidated disclosure statement dated August 30, 2023 filed with the Superintendent of Real Estate with respect to the Development.
 - (b) The Purchaser acknowledges and confirms that, before entering into this Contract, he/she/it has received a copy of, and has been given a reasonable opportunity to read, the Consolidated Disclosure Statement and any subsequent amendment(s) to disclosure statement if any, filed on or before the date hereof. The Purchaser acknowledges that the Consolidated Disclosure Statement contains the contents of the Disclosure Statement as of the date of the Consolidated Disclosure Statement (including the Initial Disclosure Statement and all amendments(s) to disclosure statement filed from time to time up to and including the date of the Consolidated Disclosure Statement).
 - (c) The Vendor acknowledges its obligation to deliver to the Purchaser an amendment (the "Building Permit Amendment") to the Disclosure Statement setting out particulars of the issued building permit in respect of the strata lots in Phase 1 of the Development and an amendment (the "Financing Amendment") to the Disclosure Statement setting out particulars of a satisfactory financing commitment in respect of the strata

INITIALS	

lots in Phase 1 of the Development, as contemplated in the Disclosure Statement. The Vendor and Purchaser agree that:

- (i) the Purchaser may cancel this Contract for a period of seven days after receipt of the Building Permit Amendment if the layout or size of the Strata Lot, the construction of a major common facility, including a recreation centre or clubhouse, or the general layout of the Development, is materially changed by the issuance of the building permit;
 - (ii) if the Building Permit Amendment is not received by the Purchaser within 12 months after the Initial Disclosure Statement was filed with the Superintendent of Real Estate (the “**Superintendent**”), the Purchaser may at his/her/its/their option cancel this Contract at any time after the end of the 12 month period until the Building Permit Amendment is received by the Purchaser, at which time the Purchaser may cancel this Contract for a period of seven days after receipt of the Building Permit Amendment only if the layout or size of the Strata Lot, the construction of a major common facility, including a recreation centre or clubhouse, or the general layout of the Development, is materially changed by the issuance of the building permit;
 - (iii) if the Financing Amendment is not received by the Purchaser within 12 months after the Initial Disclosure Statement was filed with the Superintendent, the Purchaser may at his/her/its/their option cancel this Contract at any time after the end of the 12-month period until the Financing Amendment is received by the Purchaser;
 - (iv) the amount of the Deposit to be paid by the Purchaser prior to receiving the Building Permit Amendment and the Financing Amendment will be no more than 10% of the Purchase Price; and
 - (v) all deposits paid by the Purchaser, including interest earned if applicable, will be returned promptly to the Purchaser upon notice of cancellation from the Purchaser pursuant to this section 26.
- (d) The Purchaser will, from time to time, forthwith upon receipt from the Vendor of a copy of any amendment to disclosure statement filed in respect of the Disclosure Statement, execute and deliver to the Vendor a receipt, in a form to be provided by the Vendor, pursuant to which the Purchaser confirms that it received a copy of such amendment to disclosure statement.

27. Counterparts and Delivery by Electronic Transmission. This Contract and any addendum hereto may be executed in any number of counterparts, each of which will be deemed to be an original and all of which, taken together, will be deemed to constitute one and the same instrument. Delivery of an executed copy of this Contract and any addendum hereto by any party by electronic transmission will be as effective as personal delivery of an originally executed copy of this Contract by such party.

28. Business Day. In this Contract, “**Business Day**” means any day that is not one of the following: a Saturday, Sunday, statutory holiday in British Columbia, Boxing Day, Easter Monday, the National Day for Truth and Reconciliation or any other day on which the Land Title Office is not open for business.

29. Phase. In this Contract, “**Phase 1**” and “**Phase 2**” will have the meaning given to those terms in the Disclosure Statement.

INITIALS	

EXHIBIT M

Intentionally deleted.