

THE SELKIRKS AND MONASHEES AT MACKENZIE VILLAGE

CONSOLIDATED DISCLOSURE STATEMENT

REAL ESTATE DEVELOPMENT MARKETING ACT OF BRITISH COLUMBIA

August 30, 2023

This consolidated disclosure statement relates to an offering by 0929468 B.C. Ltd. (the “**Developer**”) for the sale of proposed residential strata lots in phase 1 of a proposed 2 phase strata development known as “The Selkirks and Monashees at Mackenzie Village” (the “**Development**”) to be constructed on certain lands and premises located at 1701 Coursier Avenue, Revelstoke B.C. V0E 2S3.

This is a Consolidated Disclosure Statement filed pursuant to the Real Estate Development Marketing Act (British Columbia). This consolidated disclosure statement consolidates information contained in a disclosure statement dated December 19, 2022 as amended by an amendment to disclosure statement dated August 30, 2023.

DEVELOPER

Name:	0929468 B.C. Ltd.
Business Address and Address for Service:	Suite 900 - 900 West Hastings Street, Vancouver, B.C., V6C 1E5

BROKERAGE OF DEVELOPER

The Developer intends to market the Strata Lots (as defined in section 2.1) itself. Any employees of the Developer who market the Strata Lots on behalf of the Developer may not be licensed under the *Real Estate Services Act* (British Columbia) and are not acting on behalf of purchasers. In addition to marketing the Strata Lots itself, the Developer may also utilize the services of licensed realtors. Should the Developer utilize the services of licensed realtors, the Developer reserves the right to appoint agents from time to time or to change its agent.

This Disclosure Statement relates to a development property that is not yet completed. Please refer to section 7.2 for information on the Purchase Agreement. That information has been drawn to the attention of _____ who has confirmed that fact by initialling the space provided here _____.

DISCLAIMER

THE DISCLOSURE STATEMENT HAS BEEN FILED WITH THE SUPERINTENDENT OF REAL ESTATE, BUT NEITHER THE SUPERINTENDENT OF REAL ESTATE, NOR ANY OTHER AUTHORITY OF THE GOVERNMENT OF THE PROVINCE OF BRITISH COLUMBIA, HAS DETERMINED THE MERITS OF ANY STATEMENT CONTAINED IN THE DISCLOSURE STATEMENT OR WHETHER THE DISCLOSURE STATEMENT CONTAINS A MISREPRESENTATION OR OTHERWISE FAILS TO COMPLY WITH THE REQUIREMENTS OF THE *REAL ESTATE DEVELOPMENT MARKETING ACT* (BRITISH COLUMBIA). IT IS THE RESPONSIBILITY OF THE DEVELOPER TO DISCLOSE PLAINLY ALL MATERIAL FACTS, WITHOUT MISREPRESENTATION.

RIGHT OF RESCISSION

Under section 21 of the *Real Estate Development Marketing Act* (British Columbia), the purchaser or lessee of a development unit may rescind (cancel) the contract of purchase and sale or contract to lease by serving written notice on the Developer or the Developer's brokerage, within seven days after the later of the date the contract was entered into or the date the purchaser or lessee received a copy of this Disclosure Statement.

A purchaser may serve a notice of rescission by delivering a signed copy of the notice in person or by registered mail to:

- (A) The Developer at the address shown in the disclosure statement received by the purchaser;
- (B) The Developer at the address shown in the purchaser's purchase agreement;
- (C) The Developer's brokerage, if any, at the address shown in the disclosure statement received by the purchaser; or
- (D) The Developer's brokerage, if any, at the address shown in the purchaser's purchase agreement.

The Developer must promptly place purchaser's deposits with a brokerage, lawyer or notary public who must place the deposits in a trust account in a savings institution in British Columbia. If a purchaser rescinds their purchase agreement in accordance with the Act and regulations, the Developer or the Developer's trustee must promptly return the deposit to the purchaser.

Section 21 also provides that, subject to certain exceptions and conditions, a purchaser of a development unit may rescind a purchase agreement by serving a written notice of rescission on the developer or the developer's brokerage: (1) if the purchaser is entitled to a disclosure statement for the Development but does not receive the disclosure statement; or (2) if all of the following apply: (a) the purchaser does not receive an amendment to this Disclosure Statement which it was entitled to receive; (b) the amendment relates to or would have related to a fact or proposal to do something that is a material fact; (c) the amendment relates to or would have related to a fact or proposal to do something that was or would have been reasonably relevant to the purchaser in deciding to enter into the purchase agreement; and (d) no more than one year has elapsed after the transfer of title to the development unit to the purchaser. The foregoing rights of rescission apply regardless of whether title to the development unit has been transferred.

REAL ESTATE DEVELOPMENT MARKETING ACT (BRITISH COLUMBIA)
REQUIREMENTS

(Amended Policy Statement 5)

Amended Policy Statement 5 issued by the Superintendent of Real Estate pursuant to the *Real Estate Development Marketing Act* (British Columbia) requires that in order for a developer to market a development unit before obtaining a building permit:

- (a) The estimated date, as disclosed in the disclosure statement, for the issuance of a building permit is 12 months or less from the date the developer filed the disclosure statement with the superintendent (or if the applicable development unit was not offered for sale pursuant to the initial disclosure statement, then within 12 months after the amendment to disclosure statement offering such development unit for sale was filed with the superintendent);
- (b) The developer markets the proposed development units under the disclosure statement for a period of no more than 12 months from the date the disclosure statement was filed with the superintendent (or if the applicable development unit was not offered for sale pursuant to the initial disclosure statement, then within 12 months after the amendment to disclosure statement offering such development unit for sale was filed with the superintendent), unless an amendment to the disclosure statement that sets out particulars of the issued building permit is filed with the superintendent during that period. The developer must also either:
 - (i) prior to the expiry of the 12-month period, file with the superintendent an amendment to the disclosure statement that sets out particulars of the issued building permit; or
 - (ii) upon the expiry of the 12-month period, immediately cease marketing the development and confirm in a written undertaking to the superintendent that all marketing of the development has ceased and will not resume until after the necessary amendment has been filed, failing which a cease marketing or other order may be issued by the superintendent to the developer without further notice.

Additionally, the developer must provide written notice without delay to the superintendent if, during the 12-month period, all units in the development property being marketed under amended policy statement 5 are sold or the developer has decided not to proceed with the development.

- (c) Any purchase agreement used by the developer with respect to any development unit offered for sale or lease before the purchaser's receipt of an amendment to the disclosure statement that sets out particulars of the issued building permit must contain the following terms:
 - (i) The purchaser may cancel the purchase agreement for a period of seven days after receipt of an amendment to the disclosure statement that sets out particulars of the issued building permit if the layout or size of the applicable development unit, the construction of a major common facility, including a recreation centre or clubhouse, or the general layout of the development, is materially changed by the issuance of the building permit;
 - (ii) If an amendment to the disclosure statement that sets out particulars of an

issued building permit is not received by the purchaser within 12 months after the initial disclosure statement was filed (or if the applicable development unit was not offered for sale pursuant to the initial disclosure statement, then within 12 months after the amendment to disclosure statement offering such development unit for sale was filed), the purchaser may at his or her option cancel the purchase agreement at any time after the end of that 12-month period until the required amendment is received by the purchaser, at which time the purchaser may cancel the purchase agreement for a period of seven days after receipt of that amendment only if the layout or size of the applicable development unit, the construction of a major common facility, including a recreation centre or clubhouse, or the general layout of the development, is materially changed by the issuance of the building permit;

- (iii) The amount of the deposit to be paid by a purchaser who has not yet received an amendment to the disclosure statement that sets out particulars of an issued building permit is no more than 10% of the purchase price; and**
- (iv) All deposits paid by a purchaser, including interest earned if applicable, will be returned promptly to the purchaser upon notice of cancellation from the purchaser.**

Please see section 6.1 below in respect of the above requirements.

REAL ESTATE DEVELOPMENT MARKETING ACT (BRITISH COLUMBIA)
REQUIREMENTS
(Amended Policy Statement 6)

Policy Statement 6 issued by the Superintendent of Real Estate pursuant to the *Real Estate Development Marketing Act* (British Columbia) requires that in order for a developer to market a development unit before obtaining a satisfactory financing commitment:

- (a) The estimated date for obtaining a satisfactory financing commitment, as disclosed in the disclosure statement, is 12 months or less from the date the developer filed the disclosure statement with the superintendent (or if the applicable development unit was not offered for sale pursuant to the initial disclosure statement, then within 12 months after the amendment to disclosure statement offering such development unit for sale was filed);
- (b) The developer markets the proposed development units under the disclosure statement for a period of no more than 12 months from the date the disclosure statement was filed with the superintendent (or if the applicable development unit was not offered for sale pursuant to the initial disclosure statement, then within 12 months after the amendment to disclosure statement offering such development unit for sale was filed), unless an amendment to the disclosure statement that sets out particulars of a satisfactory financing commitment is filed with the superintendent during that period. The developer must also either:
 - (i) prior to the expiry of the 12-month period, file with the superintendent an amendment to the disclosure statement that sets out particulars of a satisfactory financing commitment; or
 - (ii) upon the expiry of the 12-month period, immediately cease marketing the development and confirm in a written undertaking to the superintendent that all marketing of the development has ceased and will not resume until after the necessary amendment has been filed, failing which a cease marketing or other order may be issued by the superintendent to the developer without further notice.

Additionally, the developer must provide written notice without delay to the superintendent if, during the 12-month period, all units in the development property being marketed under amended policy statement 6 are sold or the developer has decided not to proceed with the development.

- (c) Any purchase agreement used by the developer with respect to any development unit offered for sale or lease before the purchaser's receipt of an amendment to the disclosure statement that sets out particulars of a satisfactory financing commitment must contain the following terms:
 - (i) If an amendment to the disclosure statement that sets out particulars of a satisfactory financing commitment is not received by the purchaser within 12 months after the initial disclosure statement was filed (or if the applicable development unit was not offered for sale pursuant to the initial disclosure statement, then within 12 months after the amendment to disclosure statement offering such development unit for sale was filed),

the purchaser may at his or her option cancel the purchase agreement at any time after the end of that 12-month period until the required amendment is received by the purchaser;

- (ii) The amount of the deposit to be paid by a purchaser who has not yet received an amendment to the disclosure statement that sets out particulars of a satisfactory financing commitment is no more than 10% of the purchase price; and**
- (iii) All deposits paid by a purchaser, including interest earned if applicable, will be returned promptly to the purchaser upon notice of cancellation from the purchaser.**

Please see section 6.2 below in respect of the above requirements.

TABLE OF CONTENTS

1.	THE DEVELOPER -----	1
1.1	Particulars of Formation	1
1.2	Purpose of Formation	1
1.3	Registered and Records Office	1
1.4	Directors	1
1.5	Background of Developer, Directors, Officers and Principal Holders	1
1.6	Conflicts of Interest.....	3
2.	GENERAL DESCRIPTION -----	5
2.1	General Description of the Development.....	5
2.2	Permitted Uses	8
2.3	Phasing	9
3.	STRATA INFORMATION -----	11
3.1	Unit Entitlement	11
3.2	Voting Rights	11
3.3	Common Property and Facilities	11
3.4	Limited Common Property	13
3.5	Bylaws	15
3.6	Parking	18
3.7	Furnishings and Equipment.....	24
3.8	Budget	25
3.9	Utilities and Services	28
3.10	Strata Management Contracts	28
3.11	Insurance.....	29
4.	TITLE AND LEGAL MATTERS -----	29
4.1	Legal Description.....	29
4.2	Registered Ownership	30
4.3	Existing Encumbrances and Legal Notations	30
4.4	Proposed Encumbrances	38
4.5	Outstanding or Contingent Litigation or Liabilities	41
4.6	Environmental Matters	41
5.	CONSTRUCTION AND WARRANTIES -----	41
5.1	Construction Dates	41
5.2	Warranties	42
5.3	Previously Occupied Building.....	44
6.	APPROVALS AND FINANCES -----	44
6.1	Development Approval	44
6.2	Construction Financing.....	44
7.	MISCELLANEOUS -----	45
7.1	Deposits	45
7.2	Purchase Agreement.....	46
7.3	Developer's Commitments	53
7.4	Other Material Facts	53

1. THE DEVELOPER

1.1 Particulars of Formation

The Developer is a company incorporated under the *Business Corporations Act* (British Columbia) on January 05, 2012 under incorporation number BC0929468.

1.2 Purpose of Formation

- (a) The Developer was incorporated in order to acquire the Project Lands (as defined in subsection 2.1(f)) (which include the Lands) and to develop, market and sell the Strata Lots and certain other portions of the Project (as defined in subsection 2.1(f)).
- (b) The only assets of the Developer are:
 - (i) the Lands (as defined in section 4.1) and any rights associated with the Lands, the Development and the Project, provided that the Developer reserves the right to transfer the Remainder Lands (as defined in section 4.1) (other than the Development Parcel (as defined in section 4.1)) to one or more related or unrelated entities following the deposit of the Subdivision Plan (as defined in section 4.1); and
 - (ii) any remaining strata lots in the Mackenzie Plaza Development (as defined in section 2.1(f)). For greater certainty, the Developer has completed the sale of certain strata lots in the Mackenzie Plaza Development, and may complete the sale of some or all of the remaining strata lots in the Mackenzie Plaza Development following the date hereof and/or may retain certain of such strata lots.

1.3 Registered and Records Office

The registered and records office of the Developer is Suite 900 - 900 West Hastings Street, Vancouver, B.C., V6C 1E5.

1.4 Directors

The directors of the Developer are David Evans and Shelley Anne Evans.

1.5 Background of Developer, Directors, Officers and Principal Holders

- (a) *Disclosure of Experience in Real Estate Industry.* The following is a description of the nature and extent of the experience that the Developer and the directors and officers of the Developer have in the real estate development industry:
 - (i) The Developer was incorporated specifically for the purposes of acquiring the Project Lands and developing, marketing and selling the Strata Lots and certain other portions of the Project. The Developer has completed the development of the first development within the Project, being the EPS4700 Development (as defined in subsection 2.1(f)), and is in the process of developing the second development within the Project, being the Mackenzie Plaza Development (as defined in subsection 2.1(f)). Other than the foregoing, the Developer has not been involved in any real

estate developments and does not have any experience in the development industry.

- (ii) David Evans, a director of the Developer, has over 30 years of real estate experience and has, in his capacity as director, officer, consultant or investor of various development and investment entities, completed or been involved in the development of a number of residential and mixed-use properties in Whistler, Revelstoke, Beijing, London and other cities.
 - (iii) Shelley Anne Evans, a director of the Developer, has over 20 years of real estate experience and has, in her capacity as director, officer, consultant or investor of various development and investment entities, completed or been involved in the development of a number of residential single-family properties in Whistler and residential and mixed-use properties in Revelstoke.
- (b) *Disclosure of Penalties or Sanctions.* To the best of the Developer's knowledge, none of the Developer, nor any principal holder of the Developer, nor any of the directors or officers of the Developer or of any principal holder of the Developer, within the ten years before the date of the Developer's declaration attached to this Disclosure Statement, has been subject to any penalties or sanctions imposed by a court or regulatory authority, relating to the sale, lease, promotion, or management of real estate or securities, or to lending money secured by a mortgage of land, or to arranging, administering or dealing in mortgages of land, or to theft or fraud.
- (c) *Disclosure of Insolvency.* To the best of the Developer's knowledge, none of the Developer, nor any principal holder of the Developer, nor any of the directors or officers of the Developer or of any principal holder of the Developer, within the last five years before the date of the Developer's declaration attached to this Disclosure Statement, has been declared bankrupt or made a voluntary assignment in bankruptcy, made a proposal under any legislation relating to bankruptcy or insolvency and has not been subject to or instituted any proceedings, arrangement, or compromise with creditors or had a receiver, receiver manager or trustee appointed to hold the assets of that person.
- (d) *Disclosure Regarding Other Developers.* To the best of the Developer's knowledge, no director, officer or principal holder of the Developer, nor any director or officer of the principal holder of the Developer, within the five years prior to the date of the Developer's declaration attached to this Disclosure Statement, has been a director, officer or principal holder of any other developer that, while that person was acting in that capacity:
- (i) was subject to any penalties or sanctions imposed by a court or regulatory authority relating to the sale, lease, promotion, or management of real estate or securities, or to lending money secured by a mortgage of land, or to arranging, administering or dealing in mortgages of land, or to theft or fraud; or
 - (ii) was declared bankrupt or made a voluntary assignment in bankruptcy, made a proposal under any legislation relating to bankruptcy or insolvency or was subject to or instituted any proceedings, arrangement

or compromise with creditors or had a receiver, receiver manager or trustee appointed to hold its assets.

1.6 Conflicts of Interest

The Developer is not aware, to the best of its knowledge, of any existing or potential conflicts of interest among the Developer, manager, any principal holders of the Developer, or manager, any directors and officers of the principal holders, and any person providing goods or services to the Developer, manager or holders of the development units in connection with the Development which could reasonably be expected to affect the purchaser's purchase decision, except for the following:

- (a) Following completion of the Development, the Developer or one or more companies affiliated with the Developer may elect to retain any of the Strata Lots and may use, occupy, lease or transfer such Strata Lots on terms established by such parties.
- (b) The Parking Stalls (as defined in subsection 3.6(a)) and the Storage Lockers (as defined in subsection 3.6(e)) in the Development have been leased or will be leased by the Developer to the Parking Tenant (as defined in subsection 3.6(g)), an entity related to the Developer. If the Developer has agreed to provide any Parking Stall(s) and/or Storage Locker(s) to a purchaser of a Strata Lot, the Developer will cause the Parking Tenant to assign to the purchaser the Parking Tenant's interest in the number of Parking Stall(s) and/or Storage Locker(s), as applicable, specified in the contract of purchase and sale, and any addendum thereto, entered into by the purchaser for the purchase of the Strata Lot. In addition, the Developer or the Parking Tenant, as the case may be, may rent any Parking Stalls and/or Storage Lockers not assigned to owners or occupants of the Strata Lots to the owners and occupants of the Strata Lots, on an hourly, daily or monthly basis, or assign, or cause to be assigned, to any owners or occupants of the Strata Lots the Parking Tenant's interest in any particular Parking Stall and/or Storage Locker, while any are available, on the terms established from time to time by the Parking Tenant or the Developer, as the case may be, without compensation to the owners of the Strata Corporation (as defined in subsection 2.1(b)) or the owners of the Strata Lots. Upon the deposit of the Phase 1 Strata Plan (as defined in subsection 2.1(d)) in the Land Title Office (as defined in subsection 2.1(d)), the Strata Corporation will assume the Developer's obligations, as landlord, under the Parking and Storage Lease (as defined in subsection 3.6(g)) on terms and conditions determined by the Developer, provided however that the assumption by the Strata Corporation will be suspended insofar as the Parking and Storage Lease applies to Parking Stalls and Storage Lockers located within Phase 2 (as defined in paragraph 2.1(b)(i)) until, and conditional upon, the deposit of the Phase 2 Strata Plan (as defined in subsection 2.1(d)) in the Land Title Office. Following the deposit of the Phase 1 Strata Plan in the Land Title Office, the Developer may, in the Developer's discretion, cause the Parking Tenant to assign to the Developer some or all of the Parking Tenant's interest, as tenant, under the Parking and Storage Lease all as more particularly described in subsection 3.6(g).
- (c) The Developer will be entitled to carry out, for such period as the Developer determines to be necessary or desirable in connection with the marketing of the Development, any portion of the Project and/or any future development developed by the Developer or any affiliate of the Developer, marketing, leasing

and sales activities within the Common Property (as defined in section 2.1), any Limited Common Property amenity areas and any Strata Lots owned or leased by the Developer, including maintaining display suites, other display areas, landscaping and parking areas and permitting public access to the same. The Developer may place signage in and around any unsold Strata Lots, the Common Property and any Limited Common Property amenity areas for the duration of the marketing, leasing and sales program. The Developer may also conduct tours of the Development from time to time with prospective purchasers and tenants and hold events and other activities within the Development and use such Parking Stalls (as defined in subsection 3.6(a)) and Storage Lockers within the Development as are available and other Common Property and Limited Common Property, all as may be required in connection with such marketing, leasing and sales activities. In addition, the bylaws of the Strata Corporation, attached as Exhibit D hereto, contain certain provisions intended to enhance and protect the Developer's ability to conduct marketing, leasing and sales activities at the Development.

- (d) It is intended that the Developer will cause the Strata Corporation to enter into or to assume all obligations of the Developer under easements, statutory rights of way, restrictive covenants and other agreements which may encumber the Lands, the Development Parcel (as defined in section 4.1), the Strata Lots and/or the Common Property.
- (e) Following the filing of the Subdivision Plan, it is intended that the Developer, in its capacity as registered owner of the Development Parcel, will enter into one or more easement agreements, including, without limitation, those described in subsections 4.4(o), 4.4(p) and 4.4(q), and one or more statutory rights of way, including, without limitation, those described in subsection 7.4(g), in respect of, without limitation, access between and services for the Project Lands (as defined in subsection 2.1(f)), which easement agreements and statutory rights of way will include, without limitation, cost-sharing provisions between the Development and the other developments constructed or to be constructed on the Project Lands. The Developer will cause the Strata Corporation to assume the obligations and liabilities of the Developer, in its capacity as the registered owner of the Development Parcel, under such easement agreements and statutory rights of way once the Strata Corporation has been created. It is currently anticipated that the Remainder Lands will initially be owned by the Developer or one or more entities affiliated with the Developer, provided that the foregoing ownership arrangements are subject to change.
- (f) Until the entire Project is completed, the Developer (or an affiliate of the Developer) will remain in control of the Community Association (as defined in subsection 7.4(g)) and, accordingly and without limiting the foregoing, the Developer will have the right to make all decisions with respect to the operation, maintenance and repair by the Community Association of the Road System and the Trail System (each as defined in subsection 7.4(g)) (or the portions thereof for which the Community Association is responsible, as applicable).

2. GENERAL DESCRIPTION

2.1 General Description of the Development

(a) *Location of Development*

The Development will be located on the Development Parcel, being a portion of the Lands. The Lands are currently civically described as 1701 Coursier Avenue, Revelstoke, British Columbia (which address is subject to change at the discretion of the Developer or as required by the City of Revelstoke (the “City”). It is anticipated that the Development will be assigned multiple civic addresses by the City upon the completion of the various buildings within the Development.

(b) *Description of the Development*

(i) Phases

It is anticipated that the Development will be constructed in two phases (“**Phase 1**” and “**Phase 2**” respectively), as described more particularly in section 2.3. Each phase of the Development is referred to herein as a “**Phase**” and collectively, the “**Phases**”. The Developer currently intends to market Phase 1 as “The Selkirks at Mackenzie Village” and Phase 2 as “The Monashees at Mackenzie Village”, but reserves the right to change the name of the Phases and/or of the Development in its sole discretion at any time and from time to time.

Provided that the Developer elects to proceed with both Phases, the Development is expected to consist of 204 residential strata lots (the “**Strata Lots**”). The Strata Lots contained in Phases 1 and 2 are referred to herein as the “**Phase 1 Strata Lots**” and the “**Phase 2 Strata Lots**”, respectively.

It is intended that the Strata Lots will be constructed within 6 separate buildings, 2 of which will be four-storey buildings and 4 of which will be five-storey buildings (the “**Buildings**” and each a “**Building**”) of load bearing steel stud and light weight steel truss construction constructed above the Parking Facility (as defined in subsection 3.6(a)), as follows:

<u>Phase</u>	<u>Number of Strata Lots</u>	<u>Number of Buildings</u>
Phase 1	102	3
Phase 2	102	3

The Buildings in Phase 1, as shown on the Phase 1 Preliminary Plan (as defined in subsection 2.1(d)), are referred to herein as “**Building 1**”, “**Building 2**” and “**Building 3**”, respectively.

(ii) Strata Lots

The Strata Lots in Phase 1 are currently intended to consist of the following types:

<u>Type of Strata Lots</u>	<u>Building 1</u>	<u>Building 2</u>	<u>Building 3</u>
1 Bedroom	2	6	2
2 Bedroom	8	17	11
2 Bedroom + Den	0	0	0
3 Bedroom	18	13	19
3 Bedroom + Den	0	1	1
4 Bedroom	1	1	2
TOTAL	29	38	35

(iii) General

Each Strata Lot will be a separate Strata Lot and will be owned individually. Each purchaser will own his or her Strata Lot, together with a proportionate share of the common property (the “**Common Property**”) of the Development, the common facilities and the other assets of the strata corporation (the “**Strata Corporation**”), which the owners of the Strata Lots will own as tenants in common (subject to section 3.4 of this Disclosure Statement). The Common Property will be comprised of all the land and improvements contained within the Development, other than the Strata Lots. Collectively, all of the owners in the Development will form the Strata Corporation. Subject to certain exceptions, the Strata Corporation will be responsible for administering the Common Property, including, without limitation, the maintenance and repairs of the improvements thereon.

The Developer reserves the right to increase or decrease the number of floors of the Development, to amend the size, number and/or types of the Strata Lots from that shown on the preliminary plans for the Development, including the Phase 1 Preliminary Plan (as defined in subsection 2.1(d)), to combine two or more Strata Lots into a single Strata Lot, to consolidate any part of the Common Property with any Strata Lot, to alter the division among the types of Strata Lots and/or the types of Strata Lots, and/or to subdivide single Strata Lots into two or more Strata Lots, such that the number of Strata Lots and/or Strata Lots may vary. In addition, the Developer reserves the right to change the name of the Development, to change the civic address(es) for the Development (subject to approval by the City or at the City’s request) and the Strata Lots and/or the number assigned to each or any floor in the Development. As a consequence of any such changes, the suite and strata lot numbers assigned to any of the Strata Lots and the Unit Entitlement (as defined in section 3.1) figures with respect to any of the Strata Lots may be adjusted. Purchasers should be aware that ceiling heights of the Strata Lots may vary as a result of areas of the ceilings dropped down from the standard height thereof to accommodate construction requirements including, but not limited to, mechanical, electrical, ducting, ventilation systems, plumbing and structural requirements.

(c) *Offering for Sale*

The Developer is offering all of the Phase 1 Strata Lots for sale.

Although certain information in this Disclosure Statement relates to all of the Strata Lots which the Developer currently intends to develop in the Development, the Developer is not offering for sale, at this time, the Strata Lots located in Phase 2. The Developer will file an amendment to this Disclosure Statement before the Developer offers for sale any Phase 2 Strata Lots.

(d) *Strata Plan and Preliminary Plan*

Titles for the individual Strata Lots in a given Phase will be created by the deposit in the Kootenay Land Title Office (the “**Land Title Office**”) of a final surveyed strata plan (the “**Phase 1 Strata Plan**” and the “**Phase 2 Strata Plan**”, respectively) in respect of each such Phase.

The Phase 1 Strata Plan and the Phase 2 Strata Plan are each referred to herein as a “**Strata Plan**” and together as the “**Strata Plans**”.

The preliminary strata plan (the “**Phase 1 Preliminary Plan**”) for Phase 1 which shows the proposed layout and the proposed areas and location of the Phase 1 Strata Lots is attached as Exhibit A-1 to this Disclosure Statement.

The proposed layout of Phase 1 of the Development, including the Common Property and the Limited Common Property in Phase 1, is set out in the Phase 1 Preliminary Plan. The actual layout of Phase 1, including the Phase 1 Strata Lots, Common Property and Limited Common Property, and the actual layout, dimensions, location and area of the Phase 1 Strata Lots, may vary from what is depicted on the Phase 1 Preliminary Plan, which is based on architectural drawings, and the area of the Phase 1 Strata Lots on the final surveyed Phase 1 Strata Plan may also vary from the Phase 1 Preliminary Plan due to normal construction variations and different measurement methods.

The estimated areas, approximate dimensions, lot lines and locations of the Phase 1 Strata Lots are shown on the Phase 1 Preliminary Plan. The dimensions, areas, lot lines and locations of the Phase 1 Strata Lots, as shown on the Phase 1 Preliminary Plan, and in any sales brochures or other marketing materials, are provided for information purposes only and are not represented as being the actual final areas, lot lines, dimensions or locations of the Phase 1 Strata Lots. The Phase 1 Preliminary Plan is subject to modification based on compliance with any design or building requirements imposed by the City or any other governmental authority and based on the Developer’s requirements or the advice it receives from its consultants.

(e) *Strata Corporation*

Collectively, all of the owners of the Strata Lots will form a strata corporation (the “**Strata Corporation**”).

(f) *The Project*

The Development is part of a larger overall development (the “**Project**”), which consists of the following projects and is being developed on the following lands:

- (i) EPS4700 Lands: The first development within the Project (the “**EPS4700 Development**”) was constructed on the lands formerly legally described

as Lot 1, Plan EPP69441 (the “**EPS4700 Lands**”). The construction of the EPS4700 Development has been completed, and the EPS4700 Lands have been stratified by Strata Plan EPS4700. The EPS4700 Development consists of residential strata lots.

- (ii) Mackenzie Plaza Development Lands: The second development within the Project (the “**Mackenzie Plaza Development**”) was developed on the lands formerly legally described as Parcel Identifier: 031-465-421, Lot A Section 23 Township 23 Range 2 West of the 6th Meridian Kootenay District Plan EPP98511 (the “**Mackenzie Plaza Development Lands**”). The Mackenzie Plaza Development consists of commercial and residential strata lots constructed over two phases. The construction of the Mackenzie Plaza Development was completed in 2023, and the Mackenzie Plaza Development Lands have been stratified by Strata Plan EPS8686.
- (iii) Lands: The Development, which will be the third development within the Project, will be located on a subdivided portion of the Lands (as defined and described more particularly in section 4.1). The Lands have not yet been developed. Following completion of the Development, it is anticipated that the future developments within the Project will be located on the Remainder Lands, and that each such future development within the Project will be a separate residential strata development located within a separate legal parcel to be subdivided from the Remainder Lands in the future.

The EPS4700 Lands, the Mackenzie Plaza Development Lands and the Lands are collectively referred to herein as the “**Project Lands**”.

See subsection 7.4(g) for more information about the Project.

2.2 Permitted Uses

The zoning applicable to the Development is Comprehensive Development Zone 17 (CD17) (“**CD17 Zoning**”), pursuant to the City of Revelstoke Zoning Bylaw No. 2299, 2022 (the “**Revelstoke Zoning Bylaw**”), which zoning permits the form of the Development.

The permissible uses of the Strata Lots intended by the Developer are as follows:

- (a) apartment;
- (b) apartment building;
- (c) apartment house;
- (d) multifamily dwelling;
- (e) vacation rental unit; and
- (f) townhouse.

The foregoing permissible uses of the Strata Lots intended by the Developer are further described and have the meanings given to them in the Revelstoke Zoning Bylaw. Prospective purchasers should carefully review the Revelstoke Zoning Bylaw to ensure that their intended use of a Strata Lot is permitted.

Although the CD17 Zoning applicable to the Lands and the Development may permit other uses of the Lands and the Strata Lots beyond those intended by the Developer and described in subsections 2.2(a) to 2.2(f) above, the Strata Lots are intended to be residential, and it is the intention of the Developer that none of the Strata Lots may be used for commercial purposes or other purposes not ancillary to residential purposes. In addition, the Bylaws of the Strata Corporation will prohibit the use of any of the Strata Lots for purposes other than residential purposes and other purposes ancillary to residential purposes. Notwithstanding the foregoing and for greater certainty, the prohibition on the use of the Strata Lots for purposes other than residential purposes and other purposes ancillary to residential purposes is not intended to restrict the Strata Lots from being used as vacation rental units, provided that such use is in accordance with the Bylaws of the Strata Corporation, the Revelstoke Zoning Bylaw and all other laws and regulations applicable to the Strata Lots.

For more information relating to the zoning requirements applicable to the Lands, the Development and the Strata Lots and all permissible uses applicable to the Strata Lots, purchasers are advised as follows:

- (i) the complete text of the CD17 Zoning and the Revelstoke Zoning Bylaw are available for viewing on the City's website at:

<https://revelstoke.civicweb.net/filepro/documents/1049>

Purchasers should be aware that the Revelstoke Zoning Bylaw is subject to change by the City and that the City's website is updated from time to time and may, at any time, not be up to date; and

- (ii) purchasers may contact the City's Development Services Department as follows:

- Phone: 250-837-3637
- E-mail: development@revelstoke.ca
- Address: 216 Mackenzie Avenue, Revelstoke, B.C. V0E 2S0

The above contact information is current as of the date of this Disclosure Statement. If a purchaser calls the above number or uses the above address and they are no longer accurate, the purchaser should contact the City and ask to speak with someone in the Development Services Department.

2.3 Phasing

The Development is a phased development under the *Strata Property Act* (British Columbia) (the "**Strata Property Act**"). A phased strata development is completed in separate parts (phases) and all completed parts become one strata corporation upon the registration of the final, surveyed strata plan for each successive phase.

The Developer currently intends for the Development to consist of two Phases. The following is a description of the number of Strata Lots currently expected to be constructed in each Phase:

<u>Phase</u>	<u>Number of Strata Lots</u>
Phase 1	102
Phase 2	102
Total	204

The Developer is currently marketing only the Phase 1 Strata Lots.

Pursuant to section 221 of the *Strata Property Act*, in order to construct the Development in phases, the Developer requires approval from the approving officer (the “**Approving Officer**”) of the City with respect to a Form P – Phased Strata Plan Declaration (the “**Form P**”) for the Development. The Form P describes important aspects of the Development, including the approximate location of each Phase, the estimated total Unit Entitlement and estimated number of Strata Lots in each Phase and the date by which the Developer must elect whether to proceed with each Phase.

The Developer previously prepared a Form P (the “**Original Form P**”) that was attached as Exhibit B to the original disclosure statement dated December 19, 2022 for the Development. The Original Form P was not approved or signed by the Approving Officer. The Developer subsequently made certain changes to the Form P for the Development to reflect, among other things, changes to the number of strata lots in the Development. This Disclosure Statement was amended to include the updated Form P (the “**Revised Form P**”) by the first amendment to this Disclosure Statement. Copies of the Original Form P and the Revised Form P are attached to this Disclosure Statement as Exhibit B. The Approving Officer has not yet approved the phasing for the Development. The Approving Officer has not yet approved the Revised Form P, and has not indicated whether or not the Approving Officer is prepared to sign the Revised Form P in due course. Accordingly, the Revised Form P is subject to any changes required by the Approving Officer.

The approved Form P will be filed in the Land Title Office concurrently with the Phase 1 Strata Plan. Any changes to the approved Form P will require the approval of the Approving Officer and the Developer must comply with any requirements of the Approving Officer in connection with the phasing of the Development. The Developer may, in accordance with the *Strata Property Act*, amend the Form P, including amending the Form P to alter its proposed phasing of the Development or to change the number of Strata Lots in any Phase or in the Development in aggregate, and may elect not to proceed with future Phases of the Development, upon compliance with the requirements of the *Strata Property Act*.

In particular, the Developer may elect not to proceed with future Phases of the Development and may subdivide that portion of the Lands which would have comprised future Phases out of the Lands to create a separate legal parcel or parcels of land. In such event, such separate legal parcel or parcels of land will not form part of the Development.

3. STRATA INFORMATION

3.1 Unit Entitlement

The unit entitlement (the “**Unit Entitlement**”) of each Strata Lot is a figure indicating its share in the Common Property and common assets of the Strata Corporation and is also used to determine each Strata Lot owner’s contribution to expenses incurred in respect of the Common Property and common assets of the Strata Corporation.

The Unit Entitlement of each Strata Lot is the habitable area of each such Strata Lot in square metres, rounded to the nearest whole number, excluding any non-living areas such as patios, balconies, terraces, decks and roof decks.

The proposed schedule of Unit Entitlement for the Phase 1 Strata Lots, in Form V under the *Strata Property Act*, is attached as Exhibit C-1 to this Disclosure Statement. The calculation of Unit Entitlement for the Phase 1 Strata Lots, as set out in the schedule of proposed Unit Entitlement attached as Exhibit C-1 to this Disclosure Statement, is based on architectural drawings and will vary somewhat when calculated on the basis of the Phase 1 Strata Plan.

The final Form V for Phase 1 will be filed in the Land Title Office concurrently with the deposit of the Phase 1 Strata Plan.

3.2 Voting Rights

There will be one Strata Corporation in respect of the Strata Lots. Each Strata Lot within the Development will have one vote in the Strata Corporation.

3.3 Common Property and Facilities

(a) *General*

The Common Property is comprised of, among other things, all the land and buildings outside the individual Strata Lots but contained within the Strata Plans. Each of the Strata Lot owners is entitled to a proportionate, undivided share of the Common Property and common assets of the Strata Corporation, which the owners of the Strata Lots will own as tenants in common (subject to section 3.4 of this Disclosure Statement). The undivided share of the Common Property and common assets of the Strata Corporation owned by each owner of a Strata Lot will be based on the Unit Entitlement of such owner’s Strata Lot. Use of the Common Property by owners of the Strata Lots may be subject to certain restrictions and privileges relating to Bylaws, designations of limited common property and any licences, easements, leases or rights of way.

Costs and expenses incurred by the Strata Corporation in connection with the maintenance and repair of the Common Property and common assets will be shared by the owners of the Strata Lots on the basis of the Unit Entitlement of the Strata Lots and will be included in the owners’ monthly assessments.

(b) *Common Property*

Without limiting the generality of the foregoing, the Developer intends to include within the Common Property, for the benefit of the purchasers of the Strata Lots, the following facilities, some of which may be designated as the Limited Common Property (as

defined in section 3.4) of some of the Strata Lots, as shown for Phase 1 on the Phase 1 Preliminary Plan:

- portions of the Road System (as defined in subsection 7.4(g))
- portions of the Trail System (as defined in subsection 7.4(g))
- Parking Facility (as defined in subsection 3.6(a))
- Parking Stalls
- Storage Lockers
- Bike Storage Rooms (as defined in subsection 3.6(f))
- mechanical rooms
- certain stairwells
- certain drive aisles
- certain air intake shafts
- ramps
- certain corridors
- elevators
- certain portions of the elevator shafts
- elevator lobbies
- entryways
- planters
- service rooms
- elevator machine rooms
- certain electrical closets
- parkade exhausts
- elevator overruns
- roofs
- landscaping
- certain lobbies
- mail rooms

The approximate size and location of the areas and facilities forming part of the Common Property in Phase 1 are indicated on the Phase 1 Preliminary Plan. The Developer reserves the right to not include, or to increase or decrease the size of or alter the configuration, location or use of, any areas or facilities designated as Common Property, and may designate certain areas as Limited Common Property, all without compensation to the Strata Corporation, any section thereof and/or the purchasers of the Strata Lots.

(c) *Service Facilities*

The Development may also include additional service facilities and equipment such as transformers, fire protection systems and equipment, mechanical and electrical systems and equipment, fire prevention equipment, emergency generator systems and equipment, electrical room, vents, air shafts, ducts, fans, garage gates, drive aisles and other facilities and equipment which may not be depicted on the preliminary strata plan(s) attached hereto, but which may be required by the City or the Developer in connection with the Development (the “**Service Facilities**”). The Service Facilities will be located as required by the City or the Developer or as recommended by the Developer’s consultants.

(d) *Changes to Common Property and Common Facilities*

The Developer reserves the right to increase or decrease the proposed size, and substantially alter the proposed configuration and location, of any areas designated as Common Property including, without limitation, the Common Property facilities listed in section 3.3(b), the Service Facilities, certain portions of the Parking Facility and certain other facilities forming part of the Common Property (collectively, the “**Common Facilities**”). The Developer also reserves the right to change the facilities constituting the Common Facilities including, without limitation, changing the intended use of such facilities and/or removing any facilities from, or adding any facilities to, the list in subsection 3.3(b). In addition, the Developer reserves the right, in its sole discretion, to designate any of the Common Facilities or any other areas or amenities as Limited Common Property for the exclusive use of the owner or owners of certain adjacent or nearby Strata Lots, without compensation to the purchasers of the Strata Lots, the Strata Corporation or any section thereof.

(e) *Proximity to Common Property*

Certain of the Common Facilities may be located adjacent to or in the vicinity of certain Strata Lots. As a result, certain of the Common Facilities may obstruct views, sight lines or light in respect of the Strata Lots. In addition, noise, vibration, light and/or odours emanating from certain of the Common Facilities may be perceptible by the occupants of the Strata Lots.

3.4 Limited Common Property

(a) *Description of Limited Common Property*

Limited common property (the “**Limited Common Property**”) is an area within the Common Property that is designated for the exclusive use of one or more Strata Lot owners.

The Developer intends to designate certain areas as Limited Common Property of some or all of the Phase 1 Strata Lots approximately as shown on the Phase 1 Preliminary Plan. These areas may include patios, roof decks, garden terraces and balconies, all as shown more particularly on the Phase 1 Preliminary Plan. Such designations will be shown on the final Phase 1 Strata Plan for the Development to be deposited for registration in the Land Title Office.

(b) *Rooftop LCP Amenity Areas*

Each Building is intended to include a roof deck area (each, a “**Rooftop LCP Amenity Area**” and collectively, the “**Rooftop LCP Amenity Areas**”). The Rooftop LCP Amenity Areas are labelled as “Roof Terrace” on the Phase 1 Preliminary Plan attached as Exhibit A hereto. It is anticipated that each Rooftop LCP Amenity Area will include a hot tub(s), fire pit(s), propane grill(s), sink(s), seating, landscaping, lounging area and dining area, provided, however, that the particular items, areas and amenities in each given Rooftop LCP Amenity Area are subject to change and the Developer reserves the right to not include some or all of the foregoing items, areas and amenities, or to include certain other items, areas and amenities, in some or all of the Rooftop LCP Amenity Areas. Certain of the items and amenities in the Rooftop LCP Amenity Areas may only be available to be used on a seasonable basis.

It is intended that the Rooftop LCP Amenity Area for each given Building will be designated as Limited Common Property for the Strata Lots in that particular Building, and, accordingly, each given Rooftop LCP Amenity Area will be for the exclusive use of the owners and occupants (and their visitors) of the Strata Lots located in the Building in which such Rooftop LCP Amenity Area is located. For greater certainty, an owner or occupant of a Strata Lot will not have the right to access or use any Rooftop LCP Amenity Area other than the Rooftop LCP Amenity Area located in the particular Building in which such owner's or occupant's Strata Lot is located.

Such Limited Common Property designations will be shown on the final Strata Plans to be deposited for registration in the Land Title Office.

(c) *Changes to Limited Common Property*

The Developer reserves the right to expand and/or reduce the size of any areas designated as Limited Common Property or change any designation from Limited Common Property to Common Property, and vice versa. In addition, the Developer reserves the right to alter the designation of any areas as Limited Common Property and include such areas within the boundaries of any Strata Lots. For greater certainty, the Developer reserves the right to designate additional areas as Limited Common Property for the exclusive use of certain Strata Lots, as it considers appropriate.

In particular, certain portions of the Development shown as Common Property on the Phase 1 Preliminary Plan attached hereto may be designated on the applicable Strata Plan as Limited Common Property for some or all of the Strata Lots, including without limitation, certain drive aisles, corridors, stairwells, elevators, garbage rooms, storage rooms and other areas.

A designation of Limited Common Property on a Strata Plan may only be removed or altered by unanimous resolution of the members of the Strata Corporation.

(d) *Maintenance of Limited Common Property*

The Strata Corporation may, by bylaw, make the owners of the Strata Lots responsible for the repair and maintenance of Limited Common Property which they use. The Bylaws of the Strata Corporation will provide that Strata Lot owners or the applicable section of the Strata Corporation (as more particularly described in section 3.5) are responsible for maintaining and repairing Limited Common Property which they use, other than the following items, which are to be maintained and repaired by the Strata Corporation:

- (i) repair and maintenance that in the ordinary course of events occurs less than once a year; and
- (ii) the following, no matter how often the repair or maintenance ordinarily occurs:
 - 1. the structure of a building;
 - 2. the exterior of a building;

3. stairs, patios, balconies, terraces, decks and roof decks (including drains located thereon) and other things attached to the exterior of the building;
4. doors, windows or skylights (including without limitation frames and sills) on the exterior of the building or that front on the Common Property; and
5. fences, railings and similar structures that enclose patios, balconies, decks, roof decks and yards.

Subject to the *Strata Property Act*, common expenses of the Strata Corporation that relate to repairing and maintaining Limited Common Property are allocated only to those Strata Lots entitled to use that Limited Common Property and shared among such Strata Lots on the basis of their relative Unit Entitlement, provided that any contribution to the contingency reserve fund or any special levy which relates to Limited Common Property will be paid for by the owners of all Strata Lots in proportion to the relative Unit Entitlement of the Strata Lots.

3.5 Bylaws

The Developer intends to cause the Strata Corporation to adopt the initial bylaws (the "**Bylaws**") attached as Exhibit D to this Disclosure Statement to replace those contained in the Schedule of Standard Bylaws attached to the *Strata Property Act*.

The Developer reserves the right to make amendments to the Bylaws prior to filing the Bylaws for registration in the Land Title Office. The Bylaws will be filed for registration in the Land Title Office, in Form Y under the *Strata Property Act*, concurrently with the Strata Plan.

Prospective purchasers should carefully review the Bylaws, which govern certain of the affairs of the owners of the Strata Lots and the Strata Corporation and provide for the control, management, administration, use and enjoyment of the Strata Lots and the Common Property. Without limiting the significance of other provisions of the Bylaws, the Bylaws impose certain restrictions regarding pets, rentals, the use and resale of the Strata Lots and certain other matters, including, without limitation and as more particularly described in the Bylaws, those restrictions summarized as follows:

(a) *Use of Property*

Bylaw 1.3(a) provides that an owner, tenant, occupant, employee, agent, invitee, guest or visitor must not use a Strata Lot, the Common Property or common assets in a way that causes a nuisance, disturbance or hazard to another person, causes unreasonable or repetitive noise, unreasonably interferes with the rights of other persons to use and enjoy the Common Property, common assets or another Strata Lot, is illegal or is contrary to a purpose for which the Strata Lot or Common Property is intended as shown expressly or by necessary implication on or by the Strata Plan.

(b) *Use of Strata Lots*

Bylaw 1.3(c) provides that no owner, occupant, guest, employee, agent or invitee of the owner or occupant may use a Strata Lot for any purposes other than residential purposes and other purposes ancillary to residential purposes. For the purposes of

Bylaw 1.3(c), “ancillary to residential purposes” includes, without limitation, vacation rental.

Bylaw 1.3(c) contains extensive restrictions concerning use of the Strata Lots by residents thereof, and should be reviewed carefully by prospective purchasers. Among other restrictions, Bylaw 1.3(c) includes restrictions relating to noise, outdoor cooking devices and other items, hanging of laundry, odour, window coverings, awnings, heating and air conditioning devices, alterations, signage and security.

Bylaw 1.5 contains certain restrictions concerning alterations to the Strata Lots.

Bylaw 9.7 provides that an owner of a Strata Lot who has the benefit of Limited Common Property which includes a planter containing trees, shrubs and/or other landscaping must water and maintain the trees, shrubs and/or other landscaping installed by the Developer in such planter and such owner may not alter or remove the trees, shrubs and/or other landscaping installed by the Developer without the prior written approval of the Strata Corporation.

Bylaw 1.3(c)(xvi) provides that an owner or resident of a Strata Lot will not use, license or permit the Strata Lot to be used or occupied by any person for any type of short-term vacation or hotel-type commercial accommodation, including but not limited to, as a hotel room, bed and breakfast, home-stay student housing, Airbnb or similar service, and will not advertise or promote the use or occupancy of the Strata Lot for such purposes, unless and until the owner or resident obtains all necessary licences, including business licences, if any, from the City and provides copies of same to the Strata Corporation.

(c) *Pets*

Bylaw 9.6 imposes certain restrictions regarding pets. Among other restrictions, Bylaw 9.6(b) provides that a Strata Lot owner, tenant, occupant, employee, agent, invitee, guest or visitor must ensure that all animals are leashed or otherwise secured when on the Common Property or on land that is a common asset. Bylaw 9.6(a) provides that an owner, tenant or occupant must not keep any pets in a Strata Lot other than one or more of the following without the prior written approval of the strata corporation:

- (i) a reasonable number of fish or other small aquarium animals;
- (ii) up to 2 small caged mammals;
- (iii) up to 4 caged birds;
- (iv) dogs or cats, provided that the total number of dogs and cats does not exceed two.

(d) *Entry to a Strata Lot by the Strata Corporation*

Bylaw 1.7 provides that an owner, tenant, occupant or visitor must allow a person authorized by the Strata Corporation to enter the Strata Lot: (a) in an emergency, without notice, to ensure safety and/or prevent significant loss and/or damage, and (b) at a reasonable time, on 48 hours’ written notice, to inspect, repair or maintain Common Property, common assets of the Strata Corporation and any portions of a Strata Lot that

are the responsibility of the Strata Corporation to repair, maintain or insure under the Bylaws or the *Strata Property Act*, or to ensure compliance with the Bylaws and the *Strata Property Act*.

(e) *Certain Other Bylaws*

Bylaw 6.1 contains certain restrictions with respect to parking and storing vehicles and personal property on the Common Property (including within the Parking Facility and the Storage Lockers).

Bylaw 6.1(b) restricts an owner, tenant or occupant of a Strata Lot from renting out a Parking Stall (as defined in section 3.6) or a Storage Locker or allowing a Parking Stall or Storage Locker from being used regularly by anyone that is not an owner, tenant or occupant of a Strata Lot, the Strata Corporation or the Developer. Bylaw 6.1(b) also provides that an owner, tenant or occupant of a Strata Lot will not keep any bicycles on patios, balconies, terraces, decks or roof decks. Bylaw 7.24 also contains certain restrictions with respect to the use of the Storage Lockers and the storage of bicycles in Parking Stalls.

Bylaw 9.2 contains restrictions regarding moving into and out of Strata Lots, including the payment of a fee in connection therewith. Bylaw 9.4 provides that before a tenant may move into any Strata Lot, the owner will deliver or cause to be delivered to the Strata Corporation a "Form K - Notice of Tenant's Responsibilities" in the form set out in the *Strata Property Act*, signed by the tenant, and that an owner will advise the strata council in writing of the time and date that any tenant intends to move in or out of the Strata Lot, at least seven days in advance and will make arrangements with the manager of the building to co-ordinate any such move. Bylaw 9.5 provides that an owner of a Strata Lot, when selling his or her Strata Lot, will not permit "For Sale" signs to be placed on or about the Common Property except in a location to be determined by the strata council.

Bylaw 9.10 provides that smoking is prohibited everywhere on and within the Development, including: (i) in a Strata Lot; (ii) on the exterior Common Property; (iii) on the interior Common Property, including but not limited to in hallways, parking garages, electrical and mechanical rooms; (iv) on patios and balconies; (v) within 7.5 metres of a door, window or air intake; and (vi) on any land that is a common asset.

For the purposes of Bylaw 9.10, "smoking" includes, without limitation, emitting, causing or permitting any smoke or fume (tobacco, cannabis or otherwise) to emanate from a cigarette, electronic cigarette, vaporizer, hookah, pipe, bong, cigar or similar device or paraphernalia.

Bylaw 6.4 provides that any owner, tenant or occupant vehicle parked in violation of any of Part 6 of the Bylaws will be subject to removal by a towing company authorized by the strata council, and all costs associated with such removal will be charged to the owner of the Strata Lot.

Bylaw 9.11 contains certain restriction on the creation of noise including, without limitation, restrictions on the use or operation of noisy equipment (including, without limitation, stereos and speakers) or machinery in or around a Strata Lot between the hours of 10:00 p.m. and 7:00 a.m. or any activity that encourages loitering by persons in or about a Strata Lot or the Common Property.

(f) *Other*

Pursuant to the *Strata Property Act*, the strata corporation must not screen tenants, establish screening criteria, require the approval of tenants, require the insertion of terms in tenancy agreements or otherwise restrict the rental of a Strata Lot.

3.6 Parking

(a) *Parking Stalls and Parking Facility*

The Development will include a total of approximately 268 parking stalls (the “**Parking Stalls**”), all of which will be located in a concrete underground parking facility (the “**Parking Facility**”).

The Parking Facility will be constructed within the Lands and will form part of the Development. It is anticipated that the Parking Facility will consist of one underground level, but the Developer may, in its discretion, redesign the Parking Facility so that it includes additional underground levels, and, accordingly, the Parking Facility may include more than one underground level.

Approximately 146 of the Parking Stalls will be located in Phase 1, and approximately 122 of the Parking Stalls will be located in Phase 2. Approximately 18 of the Parking Stalls in Phase 1, and 12 of the Parking Stalls in Phase 2, will be two in line (tandem) Parking Stalls (the “**Tandem Parking Stalls**”) (being parking stalls in which the vehicles are parked end-to-end, and to reach the inner such parking stall, the vehicle must cross through the outer such parking stall).

If the Parking Facility is redesigned to include additional underground levels, then the number of Parking Stalls (and/or the number of Tandem Parking Stalls) in each Phase may change.

Although the Strata Plan will designate the Parking Stalls as Common Property, this designation will be subject to the Parking and Storage Lease and, if applicable, the Parking and Storage Lease Encumbrance. Accordingly, the purchasers of the Strata Lots will not have any right to use the Parking Stalls except as set out in subsection 3.6(g).

(b) *Street Parking Stalls and Internal Road*

In addition to the Parking Stalls, the Developer anticipates that there will be approximately 13 street parking spaces (the “**Street Parking Stalls**”) located along a new internal road (the “**Internal Road**”) known as “Coursier Avenue” to be constructed on the Development Parcel (or partially on the Development Parcel). The Internal Road and the Street Parking Stalls (or the portions thereof located on the Development Parcel, as the case may be) will form part of the Common Property of the Development. However, the Internal Road will be included in the Road System and, accordingly, will not be for the exclusive use of owners and residents of the Development. The Internal Road will be subject to the Road and Trail System Community Association SRW Agreement (as defined in paragraph 4.3(b)(xxi)) and the Road and Trail System Public SRW (as defined and described in more detail in subsection 7.4(g)) and, accordingly, the use of the Internal Road and the Street Parking Stalls will be subject to the terms and conditions set out in those agreements. The Developer will cause the Strata Corporation to assume the obligations and liabilities of the Developer, in its capacity as the registered

owner of the Development Parcel, under such agreements once the Strata Corporation has been created. It is anticipated that the Internal Road will be shared by all owners and occupants of, and visitors to, the Development and the other Project Developments and members of the general public, and that the Street Parking Stalls will be available on a “first come, first served” basis to owners and occupants of, and visitors to, the Development and the other Project Developments and members of the general public. The Community Association (as defined in subsection 7.4(g)) will be responsible for administering the use of the Street Parking Stalls.

Other than the Street Parking Stalls, there will not be any visitor parking stalls in the Development.

(c) *Disabled Parking Stalls*

It is intended that approximately 8 of the Parking Stalls (the “**Disabled Parking Stalls**”) will be designated as a disabled Parking Stalls.

Although the Strata Plan will designate the Disabled Parking Stalls as Common Property, such designations will be subject to the Parking and Storage Lease and, if applicable, the Parking and Storage Lease Encumbrance. Accordingly, a Strata Lot owner will not have any right to use a Disabled Parking Stall unless a Disabled Parking Stall is assigned to it under the Parking and Storage Lease (subject to the exchange mechanism described below). For greater certainty, the Disabled Parking Stalls may be assigned to and used by owners of the Strata Lots who do not qualify for the use of disabled parking stalls. The Developer will have the sole discretion to determine which Strata Lot owners, if any, will be assigned the use of the Disabled Parking Stalls.

The owner of the Strata Lot to whom a Disabled Parking Stall is allocated under the Parking and Storage Lease will have the exclusive use of such Disabled Parking Stall. However, such owner may be required to exchange such Disabled Parking Stall for a different Parking Stall if another owner or occupant of a Strata Lot holds a valid parking permit for disabled persons. Please see Bylaw 6.2 and section 4.5 of the Parking and Storage Lease for a description of the re-allocation mechanism for the Disabled Parking Stalls.

Notwithstanding the foregoing, the Developer may elect, subject to any applicable requirements of the City, to not include the Disabled Parking Stalls in the Development, in which event the Development may not include any parking stalls designed to accommodate vehicles used by disabled persons.

(d) *Rough-In Electrical Service for Parking Stalls*

It is intended that 115 of the Parking Stalls (the “**EV Parking Stalls**”) will be configured with an operational electric outlet and an electric service connection conduit with pull string (30 amp/208V) to enable future activation of an electric vehicle plug-in charger (an “**EV Plug-in Charger**”) for electric vehicle charging. The Developer does not intend to equip the EV Parking Stalls with EV Plug-in Chargers, but may, in its discretion, elect to do so for certain purchasers of Strata Lots for such consideration as the Developer may require.

Strata Lot owners will need the Strata Corporation’s permission to install or uninstall an EV Plug-in Charger and activate or deactivate electric service to an EV Parking Stall.

The cost of all electricity supplied to the EV Parking Stalls will be paid for by the Strata Corporation, form part of the annual budget of the Strata Corporation and be included in each Strata Lot Owner's monthly assessment. However, it is currently intended that if an owner or occupant of a Strata Lot with the right to use a given EV Parking Stall, uses that EV Parking Stall for charging an electric vehicle (as determined by the Strata Corporation), then the owner or occupant will pay a monthly user fee to the Strata Corporation in an amount determined by the Strata Corporation, from time to time, on account of electricity charges and all other costs and expenses incurred in connection with the use of such EV Parking Stall. For greater certainty, if an owner or occupant of a Strata Lot has the right to use more than one EV Parking Stall, then the foregoing user fee will be payable by the owner for each such EV Parking Stall that the owner or occupant uses for charging an electric vehicle. For greater certainty, the foregoing user fee is payable in addition to the monthly strata fee payable to the Strata Corporation. Please see Bylaw 6.3 for more information.

The Developer reserves the right to make changes to the foregoing arrangements and the Strata Corporation will, upon its formation, be responsible for administering the operation, use, maintenance and repair of the electrical infrastructure relating to the EV Parking Stalls and may adopt rules relating to same, including, without limitation, rules establishing how the costs and expenses incurred in connection with the consumption of electricity by users of the EV Parking Stalls will be apportioned.

The owner of the Strata Lot to whom an EV Parking Stall is allocated under the Parking and Storage Lease will have the exclusive use of such EV Parking Stall. However, such owner may be required to exchange such EV Parking Stall for a different Parking Stall if another owner or occupant of a Strata Lot has an electric vehicle. Please see Bylaw 6.3 and section 4.4 of the Parking and Storage Lease for a description of the re-allocation mechanism for the EV Parking Stalls.

(e) *Storage Lockers*

The Development will include one or more storage locker rooms (the "**Storage Locker Rooms**") containing a total of approximately 204 storage lockers (collectively, the "**Storage Lockers**" and each, a "**Storage Locker**") intended for the use of owners and occupants of the Strata Lots for storage purposes. It is anticipated that the Storage Locker Rooms will be located approximately as shown on the plan attached to the Parking and Storage Lease.

Although the Strata Plan will designate the Storage Lockers as Common Property, this designation will be subject to the Parking and Storage Lease and, if applicable, the Parking and Storage Lease Encumbrance. Accordingly, the owners and occupants of the Strata Lots will not have any right to use the Storage Lockers except as set out in subsection 3.6(g).

One or more Storage Locker(s) may, in the sole discretion of the Developer, be made available for purchase by purchasers of Strata Lots for an additional cost. If the purchase agreement or other agreement entered into by a purchaser of a Strata Lot and the Developer provides that the purchaser is entitled to a Storage Locker, then the Developer will cause the Parking Tenant to assign to such purchaser the Parking Tenant's interest under the Parking and Storage Lease in such Storage Locker. For greater certainty, a purchaser of a Strata Lot will not be entitled to the use of a Storage Locker unless the purchase agreement or other agreement entered into by the purchaser expressly provides that the purchaser is entitled to the use of a Storage

Locker. It is possible that not all purchasers will be entitled to the use of a Storage Locker.

The Developer will have the right to determine, in its sole discretion, the location of any Storage Lockers allocated to purchasers, and, accordingly, a purchaser of a Strata Lot will have no control of the location of any Storage Locker assigned to such purchaser, if any.

(f) *Bicycle Storage*

The Development will also include one or more bicycle storage rooms (collectively, the “**Bike Storage Rooms**”) located within the Parking Facility intended for the use of owners and occupants of the Strata Lots for bicycle storage purposes. It is anticipated that the Bike Storage Rooms will be located approximately as shown on the Plan attached to the Parking and Storage Lease. The Bike Storage Rooms will contain unenclosed bicycle racks (the “**Bike Racks**”). It is intended that each Strata Lot will have exclusive use of two Bike Racks, by way of a Limited Common Property designation on the Strata Plan. However, if the Developer deems it more appropriate, at its option, the Developer may grant to the owners of the Strata Lots rights to use the Bike Racks substantially similar to the rights granted to them through such Limited Common Property designation by the implementation of a different legal structure, including, without limitation, amending the Parking and Storage Lease so that the Bike Storage Rooms are leased thereunder and granting partial assignments of the Parking and Storage Lease with respect to particular Bike Racks to the owners of the Strata Lots.

The Developer may, in its sole discretion, offer purchasers the option to purchase, for such consideration as the Developer may require, a storage box (a “**Storage Box**”) to be installed by the Developer in the Parking Stall, if any, allocated to the purchaser.

(g) *Parking and Storage Lease*

The Developer, as landlord, has entered into a long-term pre-paid lease (the “**Parking and Storage Lease**”) in favour of Mackenzie Plaza Parking Co. Ltd. (the “**Parking Tenant**”), as tenant, with respect to all of the Parking Stalls and all of the Storage Lockers.

The Parking Tenant is related to the Developer. A copy of the Parking and Storage Lease is attached as Exhibit J to this Disclosure Statement. The Developer reserves the right to amend and/or restate the Parking and Storage Lease from time to time in its sole discretion prior to the first conveyance of a Strata Lot (including, without limitation, to include an updated copy of the plan showing the as-built location of the Parking Stalls and the Storage Lockers upon completion of construction thereof).

At the Developer’s sole option, the Parking and Storage Lease or a document securing or evidencing the Parking and Storage Lease including, without limitation, an option to lease, may be registered against title to the Lands or the Common Property, or both (collectively, the “**Parking and Storage Lease Encumbrance**”).

Upon the registration of the Phase 1 Strata Plan, the Parking and Storage Lease will be a charge on the Common Property. After the Phase 1 Strata Plan has been deposited in the Land Title Office, the Developer intends to assign the Parking and Storage Lease to the Strata Corporation and to cause the Strata Corporation to assume the Developer’s

obligations, as landlord, under the Parking and Storage Lease, on terms and conditions determined by the Developer, provided however that such assignment to, and assumption by, the Strata Corporation will be suspended insofar as the Parking and Storage Lease applies to Parking Stalls and Storage Lockers located within Phase 2 until, and conditional upon, the deposit of the Phase 2 Strata Plan in the Land Title Office. Following the deposit of the Strata Plan for each Phase in the Land Title Office and the assignment described above, the Developer may, in the Developer's discretion, cause the Parking Tenant to assign to the Developer the Parking Tenant's interest, as tenant, under the Parking and Storage Lease in those Parking Stalls and Storage Lockers located within such Phase. Notwithstanding such assignments and assumptions, the Parking Tenant (or the Developer, if the Developer so elects) will be entitled to receive and retain, as its absolute property, all amounts payable by any persons as consideration for the right to use any Parking Stalls and/or Storage Lockers.

Although the Strata Plan will designate the Parking Stalls and the Storage Lockers as Common Property, this designation will be subject to the Parking and Storage Lease and, if applicable, the Parking and Storage Lease Encumbrance. Accordingly, the owners and occupants of the Strata Lots will not have any right to use the Parking Stalls or the Storage Lockers except as set out below.

Each purchaser of a Strata Lot will be entitled to the exclusive use of the number and, if applicable, type, of Parking Stall(s) and/or Storage Locker(s) specified in the contract of purchase and sale and any addenda thereto entered into by the purchaser for the purchase of the Strata Lot (which number, in each case, may be zero, one or more than one). For greater certainty, the Developer does not guarantee that a Parking Stall or a Storage Locker will be available for each purchaser of a Strata Lot, and a purchaser of a Strata Lot will not have a right to use a Parking Stall or a Storage Locker unless the contract of purchase and sale and any addendum or amendment thereto entered into by the purchaser and the Developer for the purchase of the Strata Lot specifically states that a Parking Stall(s) and/or Storage Locker(s) will be allocated to the purchaser. The Parking Stall(s) (if any) and/or Storage Locker(s) (if any) will be allocated for use by the owners of the Strata Lots by partial assignment of the Parking and Storage Lease. Upon the transfer of a Strata Lot to a purchaser who is entitled to the exclusive use of a Parking Stall(s) (if any) and/or Storage Locker(s) (if any), the Parking Tenant or the Developer, as the case may be, will partially assign its interest under the Parking and Storage Lease with respect to the particular Stall(s) and/or Storage Locker(s) allocated to the purchaser by the Developer.

If a Purchaser is entitled to more than one Parking Stall, then such Parking Stalls may (as determined by the Developer in its sole discretion) be Tandem Parking Stalls.

The Developer reserves the right to rent, and to cause the Parking Tenant to rent, any available Parking Stalls and/or Storage Lockers to any owners or tenants of the Strata Lots on an hourly, daily or monthly basis, or to assign, or cause to be assigned, to any owners and occupants of the Strata Lots the Parking Tenant's interest under the Parking and Storage Lease in any particular Parking Stall and/or Storage Locker while any are available on the terms established from time to time by the Developer or the Parking Tenant, as the case may be. For greater certainty, the Parking Tenant may retain any remaining Parking Stalls and/or Storage Lockers throughout the term of the Parking and Storage Lease and may rent or grant partial assignments thereof on the terms established from time to time by the Parking Tenant or the Developer, without compensation to the Strata Corporation or the owners of the Strata Lots.

An owner of a Strata Lot will only be permitted to assign an interest that he or she has in any Parking Stall and/or Storage Locker under the Parking and Storage Lease to a purchaser of such Strata Lot, to an owner of another Strata Lot, to the Strata Corporation or back to the Parking Tenant or the Developer, as the case may be. The right to the exclusive use of the Parking Stalls and the Storage Lockers will terminate upon the expiry of the Parking and Storage Lease. In addition, an owner of a Strata Lot that holds an interest under the Parking and Storage Lease in a Parking Stall and/or Storage Locker may not rent or lease such Parking Stall and/or Storage Locker to any person other than an owner, purchaser or occupant of a Strata Lot, the Strata Corporation or the Parking Tenant or the Developer, as the case may be.

The Developer will have the right to determine, in its sole discretion, the location of any Parking Stalls and/or Storage Lockers allocated to purchasers and, accordingly, a purchaser of a Strata Lot will have no control over the location of any Parking Stall and/or Storage Locker assigned to such purchaser.

If the Developer deems it more appropriate, at its option, the Developer may grant to the owners of the Strata Lots rights to use the Parking Stalls and/or the Storage Lockers substantially similar to the rights granted to them through partial assignments of the Parking and Storage Lease as set out above, by the implementation of a different legal structure, including, without limitation, designation of the Parking Stalls and/or the Storage Lockers as Limited Common Property pursuant to section 258 of the *Strata Property Act*.

In addition, the Bylaws attached as Exhibit D to this Disclosure Statement contain certain provisions concerning the Parking Stalls and the Storage Lockers.

(h) *Access to Parking Facility*

The entry ramp to the Parking Facility will be accessible off the Internal Road. Access to the Parking Facility will be restricted by a security gate or vehicle door (the “**Security Gate**”) at the Parking Facility’s entrance. It is intended that the Security Gate will remain closed at all times and that only the owners and occupants of the Strata Lots, the Strata Corporation and persons authorized by the Strata Corporation may open the Security Gate.

(i) *Changes to Parking Facility, Parking Stalls and Storage Lockers*

The configuration and size of the Parking Stalls and Storage Lockers may vary. The Developer reserves the right to alter the designation of the Parking Stalls (and each type of Stall) and the Storage Lockers, in its sole discretion. As a consequence of any such changes, the number of Parking Stalls (and each type of Stall) and Storage Lockers may be adjusted. In addition, the Developer reserves the right to modify the layout and configuration of the Parking Facility and number and location of security gates and increase or decrease the number of Parking Stalls (and each type of Stall) and Storage Lockers, the size, layout and/or configuration of the Storage Lockers, the number of levels in the Parking Facility, and/or increase or decrease the number of Bike Racks, all without compensation to the Strata Corporation, any section thereof and/or the purchasers of the Strata Lots.

The Parking Stalls and Storage Lockers, including any Parking Stalls and Storage Lockers assigned to a purchaser of a Strata Lot, if any, will vary in size, shape and convenience of location, and the Parking Stalls and Storage Lockers, including any

Parking Stalls and Storage Lockers assigned to a purchaser of a Strata Lot, if any, may be partially obstructed by columns, pipes, ducts, mechanical equipment, electrical equipment and other facilities and will be assigned (if any) to purchasers thereof on an “**as is, where is**” basis, without compensation to any such purchasers in respect of any variation in the size, shape or convenience of location of such Parking Stalls and Storage Lockers.

A certain number of the Parking Stalls may be smaller in size and/or have more limited overhead capacity than the balance of the Parking Stalls and may be designated for small cars only.

For greater certainty, notwithstanding the information contained in this section 3.6 with respect to the Parking Stalls (including the total number of certain types of Parking Stalls and the number of certain types of Parking Stalls in each Phase), if the Developer elects not to proceed with Phase 2, then the Development will not include the Parking Stalls located within such Phase.

3.7 Furnishings and Equipment

The following equipment and appliances will be included in the purchase price of each Strata Lot:

- oven
- electric cook-top
- dishwasher
- refrigerator
- washer and dryer
- microwave and hood fan
- heat pump or VRV/VRF/split system for heating and cooling (or such other heating and cooling equipment as may be determined by the Developer in its sole discretion).
- electric hot water tank

In addition to the above, the Developer may, in its sole discretion, include a hot tub in certain Strata Lots for such additional consideration as the Developer may require.

Except as set out above in this section 3.7, there are no other furnishings or equipment included in the purchase price of any Strata Lot.

Any manufacturer’s warranty for any appliances and equipment located within the Strata Lots will be assigned to the respective purchasers of the Strata Lots, if and to the extent permitted by such warranty. The Developer provides no warranty with respect to the items set out above or located in the Strata Lots.

Any appliances, furnishings or equipment included in the purchase agreement for a given Strata Lot will not be encumbered except to the extent of any security documentation registered in the Land Title Office and/or the Personal Property Registry including, without limitation, the Construction Security and Mezzanine Security (each as defined in section 6.2) and any general security documents, which the Developer will cause to be discharged in accordance with section 6.2.

Any provincial sales tax or goods and service tax payable in respect of such appliances, furnishings and/or equipment will be for the account of each purchaser of a Strata Lot.

3.8 Budget

(a) *Strata Lot Expenses*

- (i) Each Strata Lot owner will be responsible for real property taxes for his or her Strata Lot. Each Strata Lot owner will also be responsible for a proportionate share of the property taxes, if any, levied in respect of the Common Property, calculated based on the Unit Entitlement for the Strata Lot. Property taxes are levied by and payable to the City.
- (ii) Except for the utilities listed in paragraph 3.8(a)(iii) below, all utilities will be separately metered for each of the Strata Lots and will be the responsibility of each Strata Lot owner. These separately metered utilities include, without limitation, electricity supplied to the Strata Lots, including, without limitation, electricity supplied to the cooktops and the domestic hot water tanks located within the Strata Lots and electricity supplied to any heating and cooling equipment within the Strata Lot.
- (iii) The aggregate cost of the following utilities utilized in respect of the Common Property or by the owners and occupants in respect of their respective Strata Lots will be paid by the Strata Corporation and the cost will be allocated to the owners of the Strata Lots in accordance with the Unit Entitlement thereof and included in the monthly assessments:
 - 1. all utilities and services for the Common Property (including propane for certain equipment within the Common Property);
 - 2. water and sewerage charges;
 - 3. heating and cooling charges within the Common Property; and
 - 4. garbage collection and recycling services provided by the City or a private company not affiliated with the Developer.

In the future, the billing structure for those utilities and services listed in subsection 3.8(a)(iii) may change such that each owner will be billed separately for these charges. Likewise, the billing structure for those utilities and services that are currently separately metered or assessed to each Strata Lot as contemplated in subsection 3.8(a)(ii) may change such that these charges will be paid by the Strata Corporation and the cost will be allocated to the owners of the Strata Lots in accordance with the Unit Entitlement thereof and included in the monthly assessments.

The Developer has made commercially reasonable efforts to estimate the rates charged by the various utilities or the City in preparing the interim budget for Phase 1 attached as Exhibit E-1 to this Disclosure Statement. However, these rates are subject to adjustments by the billing authorities.

(b) *Interim Budget*

Attached as Exhibit E-1 to this Disclosure Statement is the interim budget of estimated operating expenses for the Strata Corporation in respect of Phase 1 for the 12-month period commencing on the first day of the month following the date of the first conveyance of a Phase 1 Strata Lot to a purchaser.

Exhibit F to this Disclosure Statement includes:

- (i) an estimated cumulative budget for Phase 1 which sets out the estimated operating expenses for the Phase 1 Strata Lots following the deposit of the Phase 1 Strata Plan; and
- (ii) an estimated cumulative budget for Phase 1 and Phase 2 which sets out the estimated operating expenses for the Phase 1 Strata Lots and the Phase 2 Strata Lots following the deposit of the Phase 2 Strata Plan.

The estimated cumulative budgets in Exhibit F are based on the estimated interim budget figures, and are included for illustrative purposes only and should not be relied upon by purchasers.

Under the *Strata Property Act*, the owners of the Strata Lots are required to pay strata fees in respect of their strata lots' shares of the total contributions budgeted for the Strata Corporation's operating fund and contingency reserve fund. Exhibit G-1 to this Disclosure Statement sets out the estimated monthly assessments for the Phase 1 Strata Lots for the period during which the interim budget for Phase 1 is in effect. The estimated monthly assessments for the Phase 1 Strata Lots are based on the interim budget for Phase 1 and the estimated Unit Entitlement figures for Phase 1 set out in Exhibit C-1 to this Disclosure Statement.

The actual monthly assessments for the Strata Lots in each Phase will be calculated upon the finalization of the Unit Entitlement for the Strata Lots in such Phase. The monthly assessments for the Strata Lots will be further adjusted upon the approval by the Strata Corporation of the actual budget of operating expenses at the first annual general meeting of the Strata Corporation held following the deposit of the Strata Plan for each Phase, respectively, in the Land Title Office.

Exhibit H to this Disclosure Statement includes:

- (i) the estimated cumulative assessments for the Phase 1 Strata Lots following the deposit of the Phase 1 Strata Plan; and
- (ii) the estimated cumulative assessments for the Phase 1 Strata Lots and the Phase 2 Strata Lots following the deposit of the Phase 2 Strata Plan.

The estimated cumulative assessments in Exhibit H are based on the estimated cumulative budgets in Exhibit F and the estimated Unit Entitlement figures for the Strata Lots in each Phase. The estimated cumulative assessments in Exhibit H are included for illustrative purposes only and should not be relied upon by purchasers.

At the first annual general meeting of the Strata Corporation and each annual general meeting thereafter, the Strata Corporation will approve a new annual budget for the Strata Corporation for the following 12-month period. The actual monthly assessments for the Strata Lots for each such 12-month period will be calculated based on the approved budget and the finalized Unit Entitlement for each Strata Lot.

(c) *Interim Budget Shortfalls*

Under the *Strata Property Act*, the Developer must pay for all expenses of the Strata Corporation up to the end of the month in which the first conveyance of a Strata Lot in Phase 1 to a purchaser occurs. Following the deposit of each Phase of the Strata Plan, if the Strata Corporation's actual expenses for the applicable period (being, for Phase 1, the period commencing on the first day of the month following the date of the first conveyance of a Strata Lot to a purchaser until the first annual general meeting of the Strata Corporation and, for Phase 2, the period following the deposit of Phase 2 until the first annual general meeting following the deposit of Phase 2) exceed the estimated expenses for that period set out in the applicable interim budget, the *Strata Property Act* requires the Developer to pay the shortfall to the Strata Corporation within eight weeks after the applicable annual general meeting. In addition to paying the amount of the shortfall, the *Strata Property Act* requires the Developer to pay the Strata Corporation a penalty in the amount of twice the shortfall if the actual expenses are more than 10% but less than 20% greater than the estimated expenses set out in the interim budget, and three times the shortfall if the actual expenses are more than 20% greater than the estimated expenses set out in the interim budget.

These provisions of the *Strata Property Act* only apply to the applicable interim budgets during the periods specified above and not to any subsequent annual budget for the Strata Corporation approved at the first annual general meeting of the Strata Corporation or any subsequent annual general meeting. The foregoing provisions of the *Strata Property Act* are subject to change.

(d) *Contingency Reserve Fund*

Pursuant to the requirements of the *Strata Property Act*, the Developer will, at the time of the first conveyance of a Strata Lot in Phase 1 to a purchaser, establish a contingency reserve fund for the Strata Corporation by making a contribution to that fund equal to 5% of the estimated operating expenses set out in the interim budget for Phase 1, and, at the time of the first conveyance of a Strata Lot in Phase 2 to a purchaser, make an additional contribution of 5% of the estimated operating expenses set out in the interim budget for such Phase.

A contingency reserve fund is established to pay for common area expenses that usually occur less often than once a year or that do not usually occur. The interim budget also includes a contingency reserve fund component to which the Phase 1 Strata Lot owners will contribute by means of strata fees, equal to 10% of the estimated operating expenses as set out in the interim budget (which is in addition to the 5% initial one-time contribution by the Developer to establish the fund). The contingency reserve fund will continue to be at least 10% of the estimated operating expenses after the first annual general meeting of the Strata Corporation and is required to be at least 10% each year until the contingency

reserve fund is at least equal to 25% of the estimated operating expenses, at which time the Strata Corporation may approve a different amount.

3.9 Utilities and Services

The Development will be serviced by water supply, sanitary sewer, stormwater sewer, electricity, telephone, fire protection, internet, cablevision, garbage disposal, recycling and road access, some of which will be paid for by the Strata Corporation or the owners of the Strata Lots as provided in subsection 3.8(a).

The Development will not be serviced by natural gas, but will be serviced by piped propane for certain equipment within the Common Property, which will be paid for by the Strata Corporation as provided in subsection 3.8(a)(iii).

The wires, cables and other equipment (the “**Telecommunications Equipment**”) for the provision of telephone, cablevision, internet and certain other future telecommunication services may be owned by the supplier of such services in which case the Telecommunications Equipment would not form part of the Common Property. The purchaser of a Strata Lot and/or the Strata Corporation will be responsible for payment of hook-up and other charges payable to the utility suppliers.

It is currently intended that heating and cooling within the Strata Lots will be provided by way of either a heat pump or a VRV/VRF/split system located in each Strata Lot. However, the Developer has not yet determined which of the foregoing systems will be installed, and may, in its discretion, elect to install either such system, or may elect to install such other heating and cooling system as the Developer may determine in its discretion. The hot water within the Strata Lots will be provided by way of individual electric hot water tanks located in each Strata Lot.

The Developer has not entered into any contracts with respect to the provision of utility services to the Development other than the existing and proposed encumbrances and covenants set out in sections 4.3 and 4.4 and the agreements set out in this section 3.9, but the Developer reserves the right to do so.

The Developer may enter into, or may cause the Strata Corporation or another entity to enter into, agreements, covenants, easements and/or statutory rights of way with and/or in favour of the City, public utilities or other entities (which may be related to the Developer) with respect to the provision of utilities including, without limitation, the provision of telecommunication services (including cable television and internet) to the Development.

3.10 Strata Management Contracts

Prior to the completion of the first conveyance of a Strata Lot, the Developer intends to cause the Strata Corporation to enter into a strata management contract (the “**Management Contract**”) with a professional property management company (the “**Property Manager**”), to be selected by the Developer in its sole discretion, with respect to the control, management and administration of the Common Property. The Property Manager will not be related to the Developer.

Pursuant to the *Strata Property Act*, the Management Contract will automatically terminate on the date that is four weeks after the second annual general meeting of the Strata Corporation unless the Strata Corporation, by majority vote at the second annual

general meeting, resolves to continue the Management Contract. The Management Contract will also be terminable at any time on two months' notice: (i) by the Strata Corporation, if the cancellation is approved by a 3/4 vote at a meeting of the Strata Corporation; or (ii) by the Property Manager. The anticipated management fees payable under the Management Contract are included in the proposed interim budget(s) attached as Exhibit E-1 to this Disclosure Statement.

3.11 Insurance

The Developer or the Property Manager will, on behalf of the Strata Corporation, obtain the following insurance coverage in the name of the Strata Corporation:

- (a) replacement cost insurance on the Common Property, common assets, buildings and fixtures built or installed on the Strata Lots by the Developer as part of the original construction, including floor and wall coverings and electrical and plumbing fixtures, but excluding, if they can be removed without damage to the building, refrigerators, stoves, dishwashers or other similar items;
- (b) liability insurance for property damage and bodily injury in an amount not less than \$2,000,000; and
- (c) errors and omissions insurance for the strata council members.

The items described in 3.11(a) above will be insured against major perils, including fire, lightning, smoke, windstorm, hail, explosion, water escape, strikes, riots or civil commotion, impact by aircraft and vehicles, vandalism and malicious acts and may, in the Developer's sole discretion, be insured against earthquakes.

Each purchaser will be responsible for insuring personal property in the purchaser's own Strata Lot when the transfer of the Strata Lot from the Developer is completed.

4. TITLE AND LEGAL MATTERS

4.1 Legal Description

- (a) The Strata Lots in the Development will be located in Revelstoke, British Columbia upon a portion of a parcel of land currently legally described as follows:

Parcel Identifier: 030-260-833
Lot 2
Section 23
Township 23
Range 2 West of the 6th Meridian
Kootenay District
Plan EPP69441 Except Plan EPP98511

(the "**Lands**")

- (b) Prior to depositing the Phase 1 Strata Plan in the Land Title Office, the Developer will deposit a subdivision plan (the "**Subdivision Plan**") in respect of the Lands. The deposit of the Subdivision Plan in the Land Title Office will create: (i) a separate legal parcel (the "**Development Parcel**") consisting of a portion of the Lands, within which the Development will be located; and (ii) a separate legal

parcel (the “**Remainder Lands**”) consisting of the remainder of the Lands (other than the Development Parcel). A copy of the proposed Subdivision Plan, which shows the intended location and boundaries of the Development Parcel, is attached hereto as Exhibit K, provided that the Subdivision Plan may be revised prior to being filed. As contemplated herein, future developments may be located upon the Remainder Lands.

- (c) Following the deposit of the Subdivision Plan in the Land Title Office, it is expected that the Development Parcel will be legally described generally as follows:

Lot •
Section 23
Township 23
Range 2 West of the 6th Meridian
Kootenay District
Plan EPP•

- (d) Following the deposit of the final surveyed Phase 1 Strata Plan in the Land Title Office, it is expected that the Phase 1 Strata Lots will be legally described generally as follows:

Strata Lots 1 to 102
Section 23
Township 23
Range 2 West of the 6th Meridian
Kootenay District
Strata Plan EPS_____

together with an interest in the common property in proportion to the unit entitlement of the Strata Lots as shown on Form V.

The plan number for the Strata Plan will be assigned prior to or at the time the Phase 1 Strata Plan is deposited in the Land Title Office.

4.2 Registered Ownership

The Developer is the registered owner of the Lands.

4.3 Existing Encumbrances and Legal Notations

The following legal notations and encumbrances are presently registered or pending against title to the Lands and, unless otherwise indicated, will remain registered against title to the Lands, the Development Parcel, the Strata Lots and/or the Common Property and will bind purchasers following completion of the purchase and sale of Strata Lots:

(a) *Legal Notations*

- (i) This title may be affected by a permit under Part 14 of the Local Government Act, See CA5810046 – This legal notation is a notice that the Lands are subject to a development variance permit issued by the City pursuant to section 26 of the *Local Government Act* (British Columbia).

- (ii) This title may be affected by a permit under Part 14 of the Local Government Act, See CA5923022 – This legal notation is a notice that the Lands are subject to a development variance permit issued by the City pursuant to section 26 of the *Local Government Act* (British Columbia).
- (iii) Hereto is Annexed Easement CA6312456 over Lot 1 Plan EPP69441 – This is an easement (the “**Telecommunication, Electrical and Drainage Works Easement**”) over Lot 1, Section 23, Township 23, Range 2, West of the 6th Meridian, Kootenay District, Plan EPP69441 (“**Lot 1**”) in favour of the Lands which provides, among other things and as described more particularly therein, that:
1. the Lands have an easement over Lot 1 to install (subject to certain notice requirements and time limitations) and maintain the following works (in this paragraph, collectively, the “**Works**”) upon, over, under and across Lot 1:
 - A. telecommunication systems, including, but not limited to installation of fiber optic, cable, wire and other communication lines;
 - B. electrical transmission systems, lighting systems, including, but not limited to, poles, guys, wires, transformers and other related equipment for transmission of electricity; and
 - C. drainage works and related fixtures and equipment for the collection, conveyance and disposal of storm water;
 2. the owner of the Lands has the right to construct a road over Lot 1 for the purpose of enabling ingress to, and egress from, Lot 1;
 3. the owner of the Lands will make good at its own expense all damage or disturbance which may be caused to the surface soil of Lot 1 in the exercise of its rights under the Telecommunication, Electrical and Drainage Works Easement; and
 4. the owner of the Lands is responsible for normal and usual maintenance of the Works.
- (iv) Hereto is Annexed Easement CA6312460 over Lot 1 Plan EPP69441 – This is an easement (the “**Access Easement**”) over Lot 1 in favour of the Lands which provides, among other things and as described more particularly therein, that the Lands have an easement over that portion of Lot 1 shown outlined in heavy black on the Reference Plan of Statutory Right of Way EPP69442 (the “**EPP69442 Access Area**”) to enter into and upon the EPP69442 Access Area, with or without vehicles, for the purposes of gaining free and unobstructed access, ingress and egress between municipal vehicular or pedestrian roadways and the Lands.
- (v) This title may be affected by a permit under Part 14 of the Local Government Act, See CA8258116 – This legal notation is a notice that

the Lands are subject to a development permit issued by the City pursuant to section 490 of the *Local Government Act* (British Columbia).

- (vi) This title may be affected by a permit under Part 14 of the Local Government Act, See CA8380326 – This legal notation is a notice that the Lands are subject to a development variance permit issued by the City pursuant to section 490 of the *Local Government Act* (British Columbia).
- (vii) This title may be affected by a permit under Part 14 of the Local Government Act, See CA8670456 – This legal notation is a notice that the Lands are subject to a development variance permit issued by the City pursuant to section 490 of the *Local Government Act* (British Columbia).
- (viii) Hereto is Annexed Easement CA9219550 Lot A Plan EPP98511 (“**Easement CA9219550**”) – This is an easement over the Mackenzie Plaza Development Lands in favour of the Lands which provides, among other things and as more particularly described therein, that:
 - 1. the Lands have an easement over the Mackenzie Plaza Development Lands to install and maintain the following works (in this paragraph, collectively, the “**Works**”) upon, over, under and across the Mackenzie Plaza Development Lands:
 - A. telecommunication systems, including, but not limited to, installation of fiber optic, cable, wire and other communication lines;
 - B. electrical transmission systems and lighting systems, including, but not limited to, poles, guys, wires, transformers and other related equipment for transmission of electricity;
 - C. drainage works and related fixtures and equipment for the collection, conveyance and disposal of storm water;
 - D. water works systems and related fixtures and equipment for the collection, storage and distribution of water;
 - E. natural or propane gas transmission systems; and
 - F. sanitary sewerage works and related fixtures and equipment for the collection, conveyance and disposal of sewage;
 - 2. the owner of the Lands may pass and repass, labour, construct, erect, install, dig, carry away soil or other surface or subsurface materials, clear all trees, growth, buildings or obstruction, upon, over, under and across the Mackenzie Plaza Development Lands as may be necessary, useful or convenient in connection with the operations of the owner of the Lands in relation to the Works;

3. the owner of the Lands has a right to construct a road and all related or ancillary components or improvements for the purpose of obtaining ingress to, and egress from, the Mackenzie Plaza Development Lands;
 4. the owner of the Lands will make good at its own expense all damage or disturbance which may be caused to the surface soil of the Mackenzie Plaza Development Lands in the exercise of its rights under Easement CA9219550; and
 5. the owner of the Lands accepts sole responsibility for only normal and usual maintenance of the Works, including, but not limited to, the water works mainline, mainline valves, fire hydrants, snow plowing, street sweeping, and general surface maintenance.
- (ix) This title may be affected by a permit under Part 14 of the Local Government Act, See CB125977 – This legal notation is a notice that the Lands are subject to a development permit issued by the City pursuant to section 488 of the *Local Government Act* (British Columbia).
- (x) This title may be affected by a permit under Part 14 of the Local Government Act, See CB125978 – This legal notation is a notice that the Lands are subject to a development variance permit issued by the City pursuant to section 498 of the *Local Government Act* (British Columbia).
- (xi) This title may be affected by a permit under Part 26 of the Local Government Act, See KW55650 – This legal notation is a notice that the Lands are subject to a development variance permit issued by the City pursuant to section 922 of the *Local Government Act* (British Columbia).
- (xii) This title may be affected by a permit under Part 26 of the Local Government Act, See KX2803 – This legal notation is a notice that the Lands are subject to a development variance permit issued by the City pursuant to section 922 of the *Local Government Act* (British Columbia).
- (xiii) This title may be affected by a permit under Part 14 of the Local Government Act, See CA8994736 – This legal notation is a notice that the Lands are subject to a development variance permit issued by the City under section 498 of the *Local Government Act* (British Columbia).
- (xiv) Notice of Interest, *Builders Lien Act* (S.3(2)), see CB277883 filed 2022-10-12 – This notice of interest states that the Developer’s interest in the Lands is not bound by a lien claimed under the *Builders Liens Act* (British Columbia) in respect of an improvement on the Lands unless that improvement is undertaken at the express request of the Developer.
- (b) *Registered Encumbrances*
- (i) Covenant CA5749840 and Modification CA8181766 – These encumbrances are a covenant pursuant to section 219 of the *Land Title Act* in favour of the City and a modification of that covenant, and form part of an agreement (the “**Master Development Agreement**”) entered into by the Developer and the City with respect to the Project Lands. The

Master Development Agreement contains various obligations and restrictions relating to the development of the Project Lands, including, without limitation, that, as the Project Lands are subdivided and developed, the owner thereof will grant statutory rights of way or dedications for the Trail System as well as section 219 covenants for the maintenance of the Trail System by the owners thereof in favour of the City, the owner will grant statutory rights of way for the Road System in favour of the City and the owner will grant easements for services in favour of the remainder of the Project Lands. In the Master Development Agreement, the owner of the Lands releases and agrees to indemnify the City with respect to claims arising in connection with the Master Development Agreement.

- (ii) Covenant CA5749914 – This encumbrance is a covenant pursuant to section 219 of the *Land Title Act* in favour of the City, and forms part of an agreement (the “**Setback Agreement**”) entered into by the Developer and the City. The Setback Agreement provides, among other things and as described more particularly therein, that: (i) no buildings will be constructed in a setback area shown on the plan attached to the Setback Agreement (which setback area is a narrow strip located next to certain boundaries of the Project Lands); and (ii) the owner of the Lands releases and agrees to indemnify the City with respect to claims arising in connection with the Setback Agreement.
- (iii) Covenant CA5749915 – This encumbrance is a covenant pursuant to section 219 of the *Land Title Act* in favour of the City, and forms part of an agreement (the “**Vacation Rental Restriction Agreement**”) entered into by the Developer and the City. The Vacation Rental Restriction Agreement provides, among other things and as described more particularly therein, that: (i) only 5% of properties located adjacent to the northernmost and easternmost boundaries of the Project Lands will have permitted usage as vacation rental (as defined in the Revelstoke Zoning Bylaw); (ii) the owner of the Lands releases and agreed to indemnify the City with respect to claims arising in connection with the Vacation Rental Restriction Agreement; and (iii) the Lands will not be used except in strict compliance with the Vacation Rental Restriction Agreement. See subsection 4.3(c) for information concerning the discharge of the Vacation Rental Restriction Agreement.
- (iv) Covenant CA5749916 – This encumbrance is a covenant pursuant to section 219 of the *Land Title Act* in favour of the City, and forms part of an agreement (the “**Phasing Agreement**”) entered into by the Developer and the City. The Phasing Agreement provides, among other things and as described more particularly therein, that: (i) no buildings will be constructed on the Project Lands until the owner and the City enter into a phased development agreement; (ii) the owner of the Lands releases and agreed to indemnify the City with respect to claims arising in connection with the Phasing Agreement; and (iii) the Lands will not be used except in strict compliance with the Phasing Agreement. See subsection 4.3(c) for information concerning the discharge of the Phasing Agreement.
- (v) Covenant CA6312457 – This encumbrance is a covenant pursuant to section 219 of the *Land Title Act* in favour of the City, and forms part of an

agreement (the “**Telecommunication, Electrical and Drainage Works Agreement**”) in which the Telecommunication, Electrical and Drainage Works Easement is contained. The Telecommunication, Electrical and Drainage Works Agreement provides, among other things and as described more particularly therein, that: (i) the Telecommunication, Electrical and Drainage Works Agreement, including, without limitation, the Telecommunication, Electrical and Drainage Works Easement, will not be modified or discharged without the written consent of the City; and (ii) the owner of Lot 1 will not use any portion of Lot 1 or allow Lot 1 to be used for any purpose which would detract from or interfere with the Telecommunication, Electrical and Drainage Works Easement.

- (vi) Covenant CA6312461 – This encumbrance is a covenant pursuant to section 219 of the *Land Title Act* in favour of the City, and forms part of an agreement (the “**Access Agreement**”) in which the Access Easement is contained. The Access Agreement provides, among other things and as described more particularly therein, that the Access Agreement, including, without limitation, the Access Easement, will not be modified or discharged without the written consent of the City.
- (vii) Covenant CA6312463 – This encumbrance is a covenant pursuant to section 219 of the *Land Title Act* in favour of the City, and forms part of an agreement (the “**Access Maintenance Agreement**”) entered into by the Developer and the City. The Access Maintenance Agreement provides, among other things and as described more particularly therein, that: (i) the owner of the Lands will not construct or permit to exist any fence, barrier, sign, structure or any other improvements of any kind whatsoever in the EPP69442 Access Area which would prevent or inhibit the use and enjoyment of the rights granted pursuant to the Access Easement or the free and uninterrupted flow of traffic along the EPP69442 Access Area; (ii) upon completion of the construction of a roadway within the EPP69442 Access Area and thereafter, the owner of the Lands and the strata corporation for the EPS4700 Development will share the cost and obligation to repair and maintain the roadway constructed within the EPP69442 Access Area; and (iii) the owner of the Lands releases and agreed to indemnify the City with respect to claims arising in connection with the Access Maintenance Agreement.
- (viii) Statutory Right of Way CA6312464 – This encumbrance is a statutory right of way in favour of the City, contained in an agreement with the City relating to the use and enjoyment of a roadway to be constructed within that portion of the Lands shown outlined in heavy black on the Reference Plan of Statutory Right of Way EPP70927 (the “**EPP70927 Roadway Area**”). This statutory right of way grants to the City, its employees, agents, servants, workers, contractors, subcontractors, licensees and members of the public as invitees the right to pass and repass over the EPP70927 Roadway Area, by vehicle, by foot or by other means of conveyance, with or without animals. The owner of the Lands will not erect, place, install or maintain any building, structure, mobile home or obstruction of any kind on, over, above or under any portion of the EPP70927 Roadway Area and the owner of the Lands will not do or permit to be done anything which may interfere with the right of access granted over and upon the EPP70927 Roadway Area.

- (ix) Covenant CA6312465 – This encumbrance is a covenant pursuant to section 219 of the *Land Title Act* in favour of the City, and forms part of an agreement (the “**Roadway Maintenance Agreement**”) entered into by the Developer and the City. The Roadway Maintenance Agreement provides, among other things and as described more particularly therein, that: (i) upon completion of the construction of a roadway within the EPP70927 Roadway Area and thereafter, the owner of the Lands will be obligated to repair and maintain the roadway constructed within the EPP70927 Roadway Area in a good and proper condition as would any reasonable and prudent owner of property in the area having regard to the nature of its use; and (ii) the owner of the Lands releases and agreed to indemnify the City with respect to claims arising in connection with the Roadway Maintenance Agreement.
- (x) Covenant CA6312468 – This encumbrance is a covenant pursuant to section 219 of the *Land Title Act* in favour of the City, and forms part of an agreement (the “**Prohibition Agreement**”) entered into by the Developer and the City. The Prohibition Agreement provides, among other things and as described more particularly therein, that: (i) the owner of the Lands will not apply for any further subdivision of the Lands, will not do or permit to be done any alteration, removal or disturbance of the soil on the Lands and will not apply for a building permit in respect of the Lands; (ii) the City is not obligated to discharge the Prohibition Agreement except in accordance with the terms of the Master Development Agreement; and (iii) the owner of the Lands releases and agreed to indemnify the City with respect to claims arising in connection with the Prohibition Agreement. See subsection 4.3(c) for information concerning the discharge of the Prohibition Agreement.
- (xi) Statutory Right of Way CA6499665 – This encumbrance is a statutory right of way in favour of BC Hydro, which grants BC Hydro the right to: (i) enter upon the Lands in order to excavate for, construct, install, upgrade, operate, maintain, remove and repair all things and components necessary or convenient for the purposes of transmitting and distributing electricity and for the purpose of telecommunications (in this paragraph, collectively, the “**Works**”); (ii) clear and keep cleared that portion of the Lands located within 3 metres of either side of the centre of the alignment of the Works (in this paragraph, the “**Area of the Works**”) of any trees or growth; (iii) clear the Area of the Works and keep it cleared of any obstruction, structure, building or improvement which might interfere with the exercise of BC Hydro’s rights under the statutory right of way or create or increase any danger or hazard to the Works or any person or property in relation to the Works; (iv) enter, work, pass and repass on and along the Area of the Works; (v) have reasonable unobstructed access over the Lands to and from the Area of the Works; (vi) install service lines over or across the Lands; (vii) prune or remove trees on the Lands which might create a danger or hazard to the Works or any person or property in relation to the Works; (viii) have exclusive use and occupation of all Works installed in the ground on the Lands that are used or installed for use by BC Hydro; and (ix) do all things necessary or incidental to the foregoing.

- (xii) Statutory Right of Way CA6499666 – This encumbrance is a statutory right of way in favour of Telus, which grants Telus the right to: (i) enter upon the Lands in order to excavate for, construct, install, upgrade, operate, maintain, remove and repair all things and components necessary or convenient for the purposes of telecommunications and data transmission (in this paragraph, collectively the “**Works**”); (ii) clear and keep cleared that portion of the Lands located within 3 metres of either side of the centre of the alignment of the Works (in this paragraph, the “**Area of the Works**”) of any trees or growth; (iii) clear the Area of the Works and keep it cleared of any obstruction, structure, building or improvement which might interfere with the exercise of Telus’ rights under the statutory right of way or create or increase any danger or hazard to the Works or any person or property in relation to the Works; (iv) enter, work, pass and repass on and along the Area of the Works; (v) have reasonable unobstructed access over the Lands to and from the Area of the Works; (vi) install service lines over or across the Lands; (vii) prune or remove trees on the Lands which might create a danger or hazard to the Works or any person or property in relation to the Works; (viii) have exclusive use and occupation of all Works installed in the ground on the Lands that are used or installed for use Telus; and (ix) do all things necessary or incidental to the foregoing.
- (xiii) Intentionally deleted.
- (xiv) Intentionally deleted.
- (xv) Intentionally deleted.
- (xvi) Statutory Right of Way CA9263574 –This encumbrance is a statutory right of way in favour of the City, which grants the City a right of way over the portion of the Lands shown outlined in heavy black on the Explanatory Plan of Statutory Right of Way EPP111156 (the “**Access Area**”) for the purpose of permitting the City and its employees, agents, servants, workers, contractors, subcontractors, licensees and members of the public to pass and repass over the Access Area by vehicle, by foot or by other means of conveyance, with or without animals. Unless authorized by the City, the owner of the Lands will not erect, place, install or maintain any building, structure, mobile home or obstruction of any kind on, over, above or under any portion of the Access Area and the Owner of the Lands will not do or permit to be done anything which may interfere with the right of access granted over and upon the Access Area.
- (xvii) Intentionally deleted.
- (xviii) Mortgage CA9488891 and Assignment of Rents CA9488892 – These encumbrances are a mortgage and assignment of rents granted by the Developer in favour of Westmount West Services Inc. in connection with certain financing for the Mackenzie Plaza Development. See paragraph 4.3(c)(ii) for information concerning the discharge of this mortgage and assignment of rents.
- (xix) Intentionally deleted.

- (xx) Intentionally deleted.
 - (xxi) Statutory Right of Way CB385874 and Covenant CB385877 –These encumbrances are a statutory right of way pursuant to section 218 of the *Land Title Act* and a covenant pursuant to section 219 of the *Land Title Act* contained in an agreement (the “**Road and Trail System Community Association SRW Agreement**”) in favour of Mackenzie Village Community Association. The Road and Trail System Community Association SRW Agreement provides, among other things, and as more particularly described therein, that: (i) Mackenzie Village Community Association may enter and use the Lands and the Mackenzie Plaza Development Lands for the purposes of, among other things and as more particularly described therein, administering, operating, maintaining and repairing the Road System and the Trail System; and (ii) the Mackenzie Village Community Association may, and may permit its members and the residents, tenants and occupants of the Project Developments to, use the Road System and the Trail System at any time.
 - (xxii) Priority Agreement CB385876 and Priority Agreement CB385879 –These encumbrances are priority agreements granting Statutory Right of Way CB385874 and Covenant CB385877 priority over Mortgage CA9488891 and Assignment of Rents CA9488892.
- (c) *Discharge of Certain Registered Encumbrances*
- (i) Intentionally deleted.
 - (ii) The Developer will cause the mortgage and assignment of rents described in paragraph 4.3(b)(xviii) to be partially discharged, insofar as it pertains to any particular Strata Lot, either prior to or within a reasonable time following the completion of the sale of such Strata Lot.
 - (iii) The Developer anticipates that, following the filing of the Subdivision Plan and/or the issuance of a building permit in respect of the Development, the Vacation Rental Restriction Agreement, the Phasing Agreement and the Prohibition Agreement will be discharged from title to the Lands and/or will not be registered against title to the Development Parcel upon its creation. However, discharging the aforementioned encumbrances is not within the control of the Developer, as doing so will require the City’s consent. Accordingly, the Vacation Rental Restriction Agreement, the Phasing Agreement and/or the Prohibition Agreement may not be discharged from title to the Lands and may be registered against title to the Development Parcel upon its creation.
 - (iv) Intentionally deleted.

4.4 Proposed Encumbrances

In addition to the encumbrances listed in section 4.3, the Developer may register against the title to the Lands, the Strata Lots and/or the Common Property:

- (a) the Construction Security (as defined and described in section 6.2);

- (b) the Mezzanine Security (as defined and described in subsection 6.2);
- (c) the Deposit Protection Security (as defined and described in section 6.2);
- (d) the Parking and Storage Lease and/or the Parking and Storage Lease Encumbrance;
- (e) any amendments to, or modifications or replacements of, some or all of the legal notations, covenants, easements, statutory rights of way and other encumbrances that are described in sections 4.3 and 4.4, whether to accommodate the siting of the Development and/or any specific requirements of the development permit in respect of the Development or otherwise;
- (f) any statutory rights of way, section 219 covenants, easements, restrictive covenants or other rights or restrictions required by the City and/or Her Majesty the Queen in Right of the Province of British Columbia in connection with the approval or issuance of all development, building and occupancy permits and other approvals relating to the Lands or the development thereof, or in connection with the subdivision creating the Strata Lots;
- (g) easements in favour of adjoining properties permitting the placement of underpinning, anchor rods or other support structures below the surface of the Lands in order to facilitate construction on such adjoining properties, support for such properties during and after such construction and the ability to have the boom of any crane used in the construction of the development on such properties pass through the air space above the Lands;
- (h) one or more statutory rights of way, section 219 covenants, easements, restrictive covenants or other rights or restrictions in favour of the City in respect of:
 - (i) traffic management during the construction of the Development and certain works and services required to service the Development;
 - (ii) the construction of the Development, including design requirements, sustainable building practices, maintenance, tree retention and replacement and the payment of certain fees and charges; and
 - (iii) the construction and maintenance of certain works;
- (i) statutory rights of way over portions of the Lands for access to and the use of certain storm sewers, sanitary sewers, water mains, street lighting and gas mains;
- (j) any and all such rights of way, section 219 covenants, easements, restrictive covenants, dedications and other rights, restrictions or agreements required by the City, British Columbia Hydro and Power Authority, Shaw Cablesystems Limited, Telus Communications Inc., FortisBC Energy Inc., the Province or any other applicable governmental authority or public or private utility or other entity (which may be related to the Developer) with respect to the provision of utilities to the Development or deemed necessary or advisable by the Developer in connection with the Development;

- (k) encumbrances and/or agreements to be granted with or in favour of entities (which may be related to the Developer) and, if applicable, registered against title to the Lands, which are deemed necessary by the Developer to enable the Development to proceed;
- (l) any notices of interest filed under the *Builders Lien Act* (British Columbia);
- (m) a legal notation in respect of the approved Form P;
- (n) any easements or covenants required in connection with the phasing of the Development, including easements providing for access between the lands comprising each Phase, support for the lands comprising each Phase, the installation and maintenance of common utility lines, life safety systems, undersurface anchor rods and shoring works and similar or related works and encroachments as may be necessary in connection with the construction of each Phase of the Development, including the portion of the Parking Facility located in each Phase;
- (o) one or more statutory rights of way and/or covenants relating to the Road System and the use and maintenance thereof;
- (p) one or more statutory rights of way and/or covenants relating to the Trail System and the use and maintenance thereof;
- (q) the Project Easements (as defined in section 7.4(g)) and agreements between the owner of the Development Parcel and the owners of some or all of the other portions of the Project Lands which may include, without limitation, the following:
 - (i) easements for access to, egress from and use of certain pedestrian and vehicular access and egress routes, including, without limitation, the Trail System and the Road System;
 - (ii) easements for installation, maintenance and repair of utilities and other works upon the Development Parcel for the benefit of other Project Developments (as defined in section 7.4(g));
 - (i) easements for access to and egress from portions of the Development Parcel for the purpose of maintaining and repairing the Project Developments;
 - (ii) easements for access to and use of any amenities that are shared between Project Developments;
 - (iii) any other easements deemed necessary or desirable by the Developer in connection with the development of the Project, in order to facilitate the integration of the Development with the other components of the Project and/or any shared aspects of the Project; and
 - (iv) Community Association Cost Sharing Agreements (as defined in section 7.4(g));
- (r) the Road and Trail System Public SRW (as defined in section 7.4(g));

- (s) Other Community Facilities Charges (as defined in section 7.4(g));
- (t) one or more section 219 covenants in favour of the City relating to the maintenance and repair of the Road System and the Trail System; and
- (u) if applicable, any notices, easements, covenants and statutory rights of way necessary for the Community Association (as defined in section 7.4(g)) to exercise management and control over the Community Facilities (as defined in section 7.4(g)), including, without limitation, the Road System and the Trail System, and to perform maintenance, repairs and replacements thereof.

The Developer may also accept grants of easements, restrictive covenants or other rights or charges over neighbouring lands for the benefit of the Lands, which agreements may contain certain cost sharing provisions with respect to the use of common utility systems and common facilities.

4.5 Outstanding or Contingent Litigation or Liabilities

There is no outstanding or contingent litigation or liability in respect of the Development or the Developer which may affect the Development or the Strata Lots.

4.6 Environmental Matters

The Developer is not aware of any material facts related to flooding, the condition of soil and subsoil or other environmental matters affecting the Lands or the Development.

5. CONSTRUCTION AND WARRANTIES

5.1 Construction Dates

- (a) Estimated Date Ranges:

The estimated date range for the commencement of construction of each Building in Phase 1 is as follows:

<u>Building Number</u>	<u>Estimated Date Range for Commencement of Construction</u>
Building 1	September 1, 2023 to December 1, 2023
Building 2	September 1, 2023 to December 1, 2023
Building 3	September 1, 2023 to December 1, 2023

The estimated date range for completion of construction of each Building in Phase 1 is as follows:

<u>Building Number</u>	<u>Estimated Date Range for Completion of Construction</u>
Building 1	February 1, 2025 to May 1, 2025
Building 2	April 1, 2025 to July 1, 2025
Building 3	June 1, 2025 to September 1, 2025

- (b) The foregoing date ranges for commencement and completion of construction are estimates only and may be amended, subject to the provisions of the contracts of purchase and sale for the Strata Lots. In particular, depending on governmental approvals, construction schedules, financing arrangements, market conditions and other factors, the Developer may advance the date ranges for commencement and completion of construction to earlier dates or delay the date ranges for the commencement and completion of construction to later dates. Purchasers should be aware that the date for completion of construction and completion of the purchase and sale of the Strata Lots may be as late as the Outside Date set out in each purchaser's contract of purchase and sale plus 120 days, subject to unavoidable delay, as contemplated in the form of contract of purchase and sale for the Strata Lots attached as Exhibit I to this Disclosure Statement and as described in subsection 7.2.
- (c) The estimated date range for completion of construction set out above should not to be relied upon by purchasers of Strata Lots for determining the closing date of their purchases. The closing date for the sale and purchase of each Strata Lot will be determined in accordance with the contract of purchase and sale entered into by the purchaser in respect of such Strata Lot (as described more particularly in section 7.2), and such closing date may occur sooner or later than the estimated date range for completion of construction indicated above.

5.2 Warranties

The Developer will obtain home warranty insurance coverage for the Strata Lots from a warranty provider in accordance with the requirements of the *Homeowner Protection Act* (British Columbia) in respect of the following:

- (a) The minimum coverage for the 2 year materials and labour warranty is as follows:
- (i) in the first 12 months¹, for other than the Common Property, common facilities and other assets of the Strata Corporation:
1. coverage for any defect in materials and labour; and

¹ Section 5 of Schedule 3 of the *Homeowner Protection Act Regulation* provides that: (i) the commencement date of the home warranty insurance coverage with respect to the dwelling unit comprising a Strata Lot is the earlier of (a) the actual occupancy of the dwelling unit, and (b) the transfer of the legal title to the Strata Lot; and (ii) the commencement date of the home warranty insurance with respect to the Common Property is concurrent with the first commencement date for a dwelling unit in each separate multi-unit building comprising the Strata Plan.

2. coverage for a violation of the building code²;
- (ii) in the first 15 months, for the Common Property, common facilities and other assets of the Strata Corporation:
1. coverage for any defect in materials and labour; and
 2. coverage for a violation of the building code;² and
- (iii) in the first 24 months:
1. coverage for any defect in materials and labour supplied for the electrical, plumbing, heating, ventilation and air conditioning delivery and distribution systems;
 2. coverage for any defect in materials and labour supplied for the exterior cladding, caulking, windows and doors that may lead to detachment or material damage to the Strata Lot or Common Property;
 3. coverage for any defect in materials and labour which renders the Strata Lot or the Common Property unfit to live in; and
 4. coverage for a violation of the building code.²
- (b) The minimum coverage for the building envelope warranty is five years for defects in the building envelope of the Strata Lot or the Common Property including a defect which permits unintended water penetration such that it causes, or is likely to cause, material damage to the Strata Lot or the Common Property.
- (c) The minimum coverage for the structural defects warranty is ten years. “Structural defect” means (i) any defect in materials and labour that results in the failure of a load-bearing part of the new home, and (ii) any defect that causes structural damage that materially and adversely affects the use of the new home for residential occupancy.

Following the commencement of the home warranty insurance coverage described above with respect to the Common Property (or portions thereof), the Developer may disclose to prospective purchasers of Strata Lots the commencement and expiry dates of the home warranty insurance coverage described above with respect to the Common Property (or portions thereof) by providing an addendum to such purchasers’ contracts of purchase and sale. Accordingly, purchasers should carefully review any such addendum before entering into a contract of purchase and sale.

Any manufacturer’s warranty for appliances and equipment whether located in the Strata Lots or within the Common Property will be assigned to the purchaser of that Strata Lot

² Subject to section 1(2) of Schedule 3 of the Homeowner Protection Act Regulation which provides as follows:
 Non-compliance with the building code is considered a defect covered by home warranty insurance if the non-compliance:

- (a) constitutes an unreasonable health or safety risk, or
- (b) has resulted in, or is likely to result in, material damage to the Strata Lot or the Common Property.

or to the Strata Corporation, as applicable, if and to the extent permitted by such warranty. Improper or inadequate maintenance may void warranty coverage.

5.3 Previously Occupied Building

Not applicable for the Development. The Development has not been previously occupied.

6. APPROVALS AND FINANCES

6.1 Development Approval

- (a) The Revelstoke Zoning Bylaw, which repealed and replaced the City of Revelstoke Zoning and Development Bylaw No.1264, 1984, as amended, and permits the form of the Development, received final adoption by City Council on January 13, 2022.
- (b) The City issued Development Permit No. DP2022-008 and Development Variance Permit No. DVP2022-004 in respect of the Development on July 26, 2022.
- (c) The City has not yet issued a building permit with respect to the Phase 1 Strata Lots. The estimated date for the issuance of a building permit for the Phase 1 Strata Lots is on or before the date that is twelve months after the date that this Disclosure Statement is filed with the Superintendent (as permitted under Policy Statement 5 issued by the Superintendent). Once such a building permit for the Phase 1 Strata Lots has been issued, the Developer will file with the Superintendent an amendment to this Disclosure Statement that sets out the particulars of the issued building permit and will deliver a copy of such amendment to each purchaser which is entitled to receive same.

For clarity, a “building permit” includes one of multiple or staged building permits issued by the City with respect to the Phase 1 Strata Lots.

6.2 Construction Financing

The Developer has not yet obtained a commitment for construction financing (the “**Construction Financing**”) for the Development or any Phase thereof.

The Developer estimates that it will receive a satisfactory financing commitment for the construction of the Phase 1 Strata Lots on or before the date which is twelve months after the date on which the Developer files this Disclosure Statement with the Superintendent (as permitted under Policy Statement 6 issued by the Superintendent). Once the Developer obtains a satisfactory financing commitment with respect to the Phase 1 Strata Lots, the Developer will file with the Superintendent an amendment to this Disclosure Statement that sets out the particulars of the satisfactory financing commitment and will deliver a copy of such amendment to each purchaser which is entitled to receive same.

Following receipt of a commitment for Construction Financing, titles to the Lands and the Strata Lots may be subject to mortgages and assignments of rent and/or any other security (collectively, the “**Construction Security**”) which is reasonably required by the financial institution or other lender providing the Construction Financing (the

“Construction Lender”) in connection therewith. The Construction Lender will provide a partial discharge of the Construction Security, insofar as it pertains to any particular Strata Lot, within a reasonable period of time after the completion of the sale of such Strata Lot, upon receipt by the Construction Lender of a specified or predetermined amount from the proceeds of the sale of such Strata Lot.

In addition to the Construction Financing, the Developer may also obtain financing (the **“Mezzanine Financing”**) from a mezzanine lender (the **“Mezzanine Lender”**) for additional financing for costs relating to the acquisition, development and construction of the Development or any portion thereof. If the Developer obtains such Mezzanine Financing, title to the Lands and the Strata Lots may be subject to mortgages, assignments of rent and/or any other security reasonably required by the Mezzanine Lender (the **“Mezzanine Security”**). The Mezzanine Lender will provide a partial discharge of the Mezzanine Financing, insofar as it pertains to any particular Strata Lot, within a reasonable period of time after the completion of the sale of such Strata Lot, upon receipt by the Mezzanine Lender of a specified or predetermined amount from the proceeds of the sale of such Strata Lot.

The Developer may also, in its discretion, enter into a Deposit Protection Contract (as defined in section 7.1), as more particularly described in section 7.1. If the Developer enters into a Deposit Protection Contract, title to the Lands and the Strata Lots may be subject to mortgages, assignments of rent and/or any other security reasonably required in connection with Deposit Protection Contract (the **“Deposit Protection Security”**). The Developer will cause any Deposit Protection Security registered against title to the Strata Lots to be partially discharged from title to any particular Strata Lot within a reasonable time after receipt of the net sale proceeds from the purchaser thereof.

7. MISCELLANEOUS

7.1 Deposits

Subject to legal remedies in respect of defaults under the contract of purchase and sale entered into between the purchaser and the Developer, and except as otherwise provided in this section 7.1, where required under the *Real Estate Development Marketing Act* (British Columbia) (**“REDMA”**), all deposits and other monies received from a purchaser of a Strata Lot will be held by the Developer’s lawyers, Terra Law Corporation, in trust in the manner required by REDMA until such time as:

- (a) the applicable Strata Plan is deposited in the Land Title Office;
- (b) the approvals required for the lawful occupation of the Strata Lot have been obtained; and
- (c) an instrument evidencing the interest of the purchaser in the Strata Lot has been filed for registration in the Land Title Office.

The interest, if any, accrued on the deposits will be for the account of and payable to the Developer.

Notwithstanding the foregoing, the Developer may, in its discretion, enter into a deposit protection contract with an approved insurer or another form of security agreement (the **“Deposit Protection Contract”**) as contemplated by REDMA and, if the Developer does so, the deposit may be released to the Developer and used by the Developer for

purposes related to the Development, including the construction and marketing thereof, and the Deposit Protection Contract will remain in effect until subsections 7.1(a), 7.1(b), and 7.1(c) have been satisfied.

If the Developer enters into a Deposit Protection Contract, an amendment to this Disclosure Statement setting out the particulars of the Deposit Protection Contract will be filed with the Superintendent and a copy of the amendment will be delivered to each purchaser of a Strata Lot.

7.2 Purchase Agreement

A copy of the form of offer to purchase and agreement of purchase and sale (the "**Purchase Agreement**") that the Developer intends to use in connection with the sale of the Strata Lots in Phase 1, unless otherwise agreed to between the Developer and a purchaser, is attached as Exhibit I to this Disclosure Statement. The Purchase Agreement provides, among other things, as follows:

- (a) The completion date (the "**Completion Date**") will be the date identified by written notice given by the Developer or its solicitors to the purchaser or the purchaser's solicitors or notary as a date on which the Strata Lot is or will be ready to be occupied, provided the Developer or its solicitors will give not less than 10 days' notice thereof. If the completion date is a Saturday, Sunday, statutory holiday or a day upon which the Land Title Office is not open for business, the Completion Date will be the immediate following day on which the Land Title Office is open for business. The notice of the Completion Date may be based on the Developer's estimate as to when the Strata Lot will be ready to be occupied. If the Strata Lot is not ready to be occupied on the Completion Date so established, then the Developer may delay the Completion Date from time to time as required, by written notice of such delay to the purchaser or its solicitors, subject to the provisions described in subsection 7.2(c) below.
- (b) The obligation of the Developer to complete the sale of the Strata Lot is subject to the Developer obtaining construction financing in respect of the Phase 1 Strata Lots that is satisfactory to the Developer in its sole, absolute and unfettered discretion on or before the date specified in section 6 of Schedule A to the Purchase Agreement. The foregoing condition is for the exclusive benefit of the Developer and may be waived by the Developer at any time on or prior to the time set forth for satisfaction of the same. The condition will be deemed to have been waived within the time set forth if the purchaser has not received, within seven (7) days following the date on which such condition is to be satisfied, notification from the Developer that such condition has not been satisfied or waived. In the event the Developer provides notice within such seven (7) day period that such condition is not waived or satisfied, the Purchase Agreement will be terminated, whereupon the deposit will be forthwith returned to the purchaser without deduction, and the Purchase Agreement will thereupon be null and void, and of no further force or effect, and the Developer will not be liable for any costs or damages suffered by the purchaser as a result of or in connection with the Purchase Agreement or as a direct or indirect result of its termination. The Purchase Agreement is irrevocable by the purchaser notwithstanding the foregoing condition precedent.
- (c) If the Completion Date for the purchase and sale of the Strata Lot has not occurred by the Outside Date (as defined and specified in section 1 of

Schedule A of the Purchase Agreement), the Purchase Agreement will terminate on the Outside Date, the deposit and interest thereon will be returned to the purchaser and the parties will have no further obligations under the Purchase Agreement, provided that:

- (i) if the Developer is delayed from completing construction of the Strata Lot as a result of epidemic, pandemic, earthquake, flood or other act of God, fire, explosion, terrorism or accident, howsoever caused, act of any governmental authority, strike, lockout, inability to obtain or delay in obtaining labour, supplies, materials or equipment, delay or failure by carriers or contractors, breakage or other casualty, climactic condition, interference of the purchaser, or any other event of any nature whatsoever beyond the reasonable control of the Developer, then the Developer may, at its option exercisable by written notice to the purchaser, in addition to any extension pursuant to the provision described in paragraph 7.2(c)(ii) and whether or not any extension pursuant to the provision described in paragraph 7.2(c)(ii) has been exercised, elect to extend the Outside Date by a period equivalent to such period of delay; and
- (ii) the Developer may, at its option exercisable by written notice to the purchaser, in addition to any extension pursuant to the provision described in paragraph 7.2(c)(i) and whether or not any extension pursuant to the provision described in paragraph 7.2(c)(i) has been exercised, elect to extend the Outside Date for up to 120 days.

The purchaser acknowledges that the estimated date range for completion of construction set out in this Disclosure Statement has been provided by the Developer as a matter of convenience only, is not meant to be legally binding upon the Developer and that the actual Completion Date will be established in the manner set out in the Purchase Agreement.

- (d) Time will be of the essence of the Purchase Agreement. If the purchaser fails to make any payment on account of the Purchase Price (as defined in the Purchase Agreement), including, without limitation, any portion of the Deposit (as defined in the Purchase Agreement) or the balance of the Purchase Price, together with adjustments thereto as provided in the Purchase Agreement, when due or fails to pay any other amount payable under the Purchase Agreement when due, then the Developer may, at its option:
 - (i) terminate the Purchase Agreement by written notice to the purchaser and, in such event, the portion of the Deposit that has been paid and all interest accrued thereon will be absolutely forfeited to the Developer as liquidated damages, the parties agreeing that the total amount of the Deposit (including all portions thereof, whether paid or unpaid) together with interest thereon constitutes a genuine pre-estimate of the damages the Developer will suffer as a result of the purchaser's failure to pay, when due, any payment on account of the Purchase Price, together with adjustments thereto as provided in the Purchase Agreement, or any other amounts payable under the Purchase Agreement, without prejudice to the Developer's other remedies including, without limitation, the right of the Developer to pursue the purchaser for any unpaid balance of the Deposit and to seek additional damages and, subject to the provisions of REDMA,

the Developer's solicitors are irrevocably authorized and directed by the purchaser to pay the amount held by them and such interest as may have accrued thereon to the Developer upon written demand therefor by the Developer; or

- (ii) elect to extend the date for payment or the Completion Date, as applicable, to a certain date determined by the Developer, time to remain of the essence of the Purchase Agreement and subject to the Developer's right in its sole discretion, to grant further extensions to a certain date each time, in which event the purchaser will pay to the Developer, in addition to the Purchase Price, interest on the unpaid portion of the Purchase Price and other unpaid amounts payable under the Purchase Agreement at the rate of 2% per month (26.82% per annum), calculated daily and compounded monthly not in advance, from the date upon which such portion and amounts were due to the date upon which such portion and amounts are paid.

The Developer may cancel the Purchase Agreement pursuant to the provision described in paragraph 7.2(d)(i) or grant one or more further extensions pursuant to the provision described in paragraph 7.2(d)(ii), at any time after extending the date for payment or the Completion Date, as the case may be, pursuant to the provision described in paragraph 7.2(d)(ii) if the purchaser fails to make such payment or complete the purchase of the Strata Lot, as the case may be, in accordance with the Purchase Agreement on or before such extended date.

- (e) The Developer may in its sole discretion terminate the Purchase Agreement if the Developer has reasonable grounds to suspect that any part of the transaction contemplated by the Purchase Agreement is related to the commission or attempted commission of a "money laundering offence" or a "terrorist activity financing offence", as defined in the *Proceeds of Crime (Money Laundering) and Terrorist Financing Act (Canada)* and regulations under that Act, as amended from time to time, in which event the portion of the Deposit that has been paid, together with all interest thereon, will be returned to the purchaser and the purchaser will have no further claims against the Developer.
- (f) Interest on the Deposit paid pursuant to the Purchase Agreement will be for the benefit of the Developer. From and after the release of the Deposit or any portion thereof pursuant to a Deposit Protection Contract, no further interest will be earned on the amount so released.
- (g) The total amount of the Deposit (including all portions thereof, whether paid or unpaid) together with interest thereon constitutes a genuine pre-estimate of the damages the Developer will suffer as a result of the purchaser's failure to pay any portion of the Deposit when required under the Purchase Agreement or failure to complete the purchase of the Strata Lot in default of its obligations under the Purchase Agreement. If the purchaser fails to pay any portion of the Deposit when required under the Purchase Agreement or fails to complete the purchase of the Strata Lot in default of his/her/its/their obligations under the Purchase Agreement, then subject to the provision described in subsection 7.2(d)(ii), the Developer may elect to terminate the Purchase Agreement and, in such event, the portion of the Deposit that has been paid together with interest thereon will be absolutely forfeited to the Developer as liquidated damages, without prejudice to any other remedy which the Developer

may have in respect of the purchaser's default including, without limitation, the right of the Developer to pursue the purchaser for any unpaid balance of the Deposit and to seek additional damages.

- (h) If the Developer fails to complete the sale of the Strata Lot, then the Deposit paid will be paid to the purchaser, together with any interest earned thereon, as the purchaser's sole and exclusive remedy in accordance with the provision described in subsection 7.2(i).
- (i) Any and all claims, whether in contract or tort, which the purchaser has or hereafter may have against the Developer in any way arising out of, or related to, the Strata Lot or the Developer's obligations and covenants pursuant to the Purchase Agreement will be limited to the amount paid by the purchaser on account of the Deposit. If the Developer fails to complete the sale of the Strata Lot in default of its obligations under the Purchase Agreement, then the Deposit will be repaid to the purchaser as liquidated damages as the purchaser's sole and exclusive remedy and the purchaser will have no further claims whatsoever against the Developer in respect of such default and the Developer will have no further obligations or liabilities whatsoever under the Purchase Agreement, and the purchaser releases and discharges the Developer from any claim beyond the amount of the Deposit. The Developer will not be liable for any damages or costs whatsoever beyond the amount of the Deposit which may be incurred by the purchaser resulting from any such failure including, without limiting the generality of the foregoing, relocation costs, professional fees and disbursements, opportunity costs, loss of bargain, damages and/or costs resulting from hardship or any other damages or costs incurred by the purchaser, directly or indirectly, as a result of the Developer's default.
- (j) The Developer intends to deliver to the purchaser an amendment (the "**Building Permit Amendment**") to this Disclosure Statement setting out particulars of the issued building permit in respect of the Phase 1 Strata Lots and an amendment (the "**Financing Amendment**") to this Disclosure Statement setting out particulars of a satisfactory financing commitment in respect of the Phase 1 Strata Lots, and:
 - (i) the purchaser may cancel the Purchase Agreement for a period of seven days after receipt of the Building Permit Amendment if the layout or size of the Strata Lot, the construction of a major common facility, including a recreation centre or clubhouse, or the general layout of the Development, is materially changed by the issuance of the building permit;
 - (ii) if the Building Permit Amendment is not received by the purchaser within 12 months after this Disclosure Statement was filed with the Superintendent, the purchaser may at his/her/its/their option cancel the Purchase Agreement at any time after the end of the 12 month period until the Building Permit Amendment is received by the purchaser, at which time the purchaser may cancel the Purchase Agreement for a period of seven days after receipt of the Building Permit Amendment only if the layout or size of the Strata Lot, the construction of a major common facility, including a recreation centre or clubhouse, or the general layout of the Development, is materially changed by the issuance of the building permit;

- (iii) if the Financing Amendment is not received by the purchaser within 12 months after this Disclosure Statement was filed with the Superintendent, the purchaser may at his/her/its/their option cancel the Purchase Agreement at any time after the end of the 12 month period until the Financing Amendment is received by the purchaser;
- (iv) the amount of the Deposit to be paid by the purchaser prior to receiving the Building Permit Amendment and the Financing Amendment will be no more than 10% of the Purchase Price; and
- (v) all Deposits paid by the purchaser, including interest earned if applicable, will be returned promptly to the purchaser upon notice of cancellation from the purchaser pursuant to the provisions of the Purchase Agreement described in this subsection 7.2(j).

The Developer may from time to time use another form or forms of purchase agreement in connection with the sale of the Strata Lots after the filing of the Building Permit Amendment and the Financing Amendment.

- (k) The purchaser acknowledges and agrees that, in accordance with Section 19 of REDMA, the Developer may enter into a deposit protection contract with an approved insurer, pursuant to which the deposits paid by purchasers of strata lots in the Development, including the Deposit, are insured and, as such, may be released, in whole or in part, to the Developer. Upon the release of the Deposit or any portion thereof to the Developer in accordance with the Deposit Protection Contract, the provisions of the Purchase Agreement will be deemed to have been amended accordingly. The purchaser acknowledges that from and after the release of the Deposit or any portion thereof pursuant to a Deposit Protection Contract, no further interest will be earned on the amount so released.
- (l) The Purchase Agreement includes the following terms:
 - (i) In accordance with section 20.3(1) of REDMA and section 10.2(1) of the Real Estate Development Marketing Regulation, B.C. Reg. 505/2004 (the "**REDMA Regulation**"), the Developer and the purchaser agree as follows:
 1. Without the Developer's prior consent, any assignment of the Purchase Agreement is prohibited.
 2. An assignment under REDMA is a transfer of some or all of the rights, obligations and benefits under a purchase agreement made in respect of a strata lot in a development property, whether the transfer is made by the purchaser under the purchase agreement to another person or is a subsequent transfer.
 3. Each proposed party to an assignment agreement must provide the Developer with the information and records required under REDMA.
 - (ii) Pursuant to section 20.3(1) of REDMA and section 10.2(2) of the REDMA Regulation, the Developer hereby gives notice to the purchaser of the following:

Before the Developer consents to the assignment of the Purchase Agreement, the Developer will be required to collect information and records under the *Real Estate Development Marketing Act* from each proposed party to an assignment agreement, including personal information, respecting the following:

- a) the party's identity;
- b) the party's contact and business information;
- c) the terms of the assignment agreement.

Information and records collected by the Developer must be reported by the Developer to the administrator designated under the *Property Transfer Tax Act*. The information and records may only be used or disclosed for tax purposes and other purposes authorized by section 20.5 of the *Real Estate Development Marketing Act*, which includes disclosure to the Canada Revenue Agency.

- (iii) Without limiting anything set out in the provisions described in paragraphs 7.2(l)(i) and 7.2(l)(ii), prior to the Developer consenting to any assignment of the Purchase Agreement, the purchaser will cause each proposed party to an assignment agreement to give to the Developer all information and records prescribed pursuant to section 20.3(2) of REDMA and/or section 10.3 of the REDMA Regulation (collectively, the "**Prescribed Information and Records**").
- (iv) If the Developer consents to any assignment of the Purchase Agreement, the purchaser will cause the parties to the assignment agreement to forthwith deliver to the Developer a copy of the written and signed assignment agreement, and the purchaser acknowledges and agrees that the Developer may keep and use such copy of the assignment agreement for such purposes as may be required or permitted under REDMA or the REDMA Regulation.
- (v) The purchaser acknowledges and agrees that the Developer may, at any time and from time to time, (i) file the Prescribed Information and Records, as well as any other information and records regarding the purchaser, any assignee or proposed assignee of the Purchase Agreement and/or any assignment or proposed assignment of the Purchase Agreement, with the administrator designated under the *Property Transfer Tax Act* and (ii) disclose the Prescribed Information and Records and such other information and records to such persons as may otherwise be required by law.
- (vi) Forthwith upon the request of the Developer, the purchaser will provide, and will cause any assignee or proposed assignee of the Purchase Agreement to provide, such other information and records as the Developer may require or desire in connection with any assignment or proposed assignment of the Purchase Agreement, including information regarding the purchaser, the assignee or proposed assignee and/or the assignment or proposed assignment of the Purchase Agreement. The

purchaser acknowledges that REDMA may be amended from time to time to modify the obligations and requirements, or to impose additional obligations and requirements, of the Developer and/or the purchaser with respect to assignments of purchase agreements, and the purchaser covenants and agrees to comply with all such obligations and requirements and to cooperate with the Developer and promptly comply with all requests of the Developer in relation to such obligations and requirements.

- (vii) For greater certainty, and notwithstanding anything else in the provision described in this subsection 7.2(l), the notices, terms and conditions in the provision described in this subsection 7.2(l) do not: (1) constitute consent by the Developer to any assignment of the Purchase Agreement; (2) obligate the Developer to consent to any assignment of the Purchase Agreement; or (3) derogate from, diminish, limit, amend or affect the Developer's right to arbitrarily withhold its consent to any assignment of the Purchase Agreement in the Developer's sole and unfettered discretion in accordance with the Purchase Agreement as described in subsection 7.2(m). Accordingly, the purchaser should not enter into the Purchase Agreement with any expectation of, on reliance upon, the purchaser's ability to assign the Purchase Agreement in the future.

- (m) The purchaser will not assign its interest in the Strata Lot or in the Purchase Agreement without the prior written consent of the Developer, which consent may be arbitrarily withheld in the Developer's sole and unfettered discretion. Unless the Developer so consents, the Developer is not required to convey the Strata Lot to anyone other than the purchaser named in the Purchase Agreement. The purchaser will not, at any time before the Completion Date, advertise or solicit offers from the public with respect to the assignment of the Purchase Agreement or the resale of the Strata Lot by the purchaser without the prior written consent of the Developer, which consent may be arbitrarily withheld in the Developer's sole and unfettered discretion, and in particular, the purchaser will not list the Strata lot or the purchaser's interest in the Purchase Agreement on any Multiple Listing Service (MLS). As a condition for agreeing to an assignment of the purchaser's interest in the Strata Lot or in the Purchase Agreement and for any associated legal and administrative costs, the Developer may, at its sole option, charge an administration fee equal to 2% of the Purchase Price except that there will be a flat fee of \$350.00 if the assignee is the purchaser's spouse, parent or child, or a company controlled by the purchaser. Following any assignment, the assignor will not be relieved of its obligations under the Purchase Agreement but will continue to remain liable to perform all obligations of the purchaser under the Purchase Agreement.

- (n) Pursuant to Policy Statement 16 issued by the Superintendent pursuant to REDMA, the following terms and notice are required to be included in this section 7.2:

Without the developer's prior consent, any assignment of a purchase agreement is prohibited.

An assignment under the *Real Estate Development Marketing Act* is a transfer of some or all of the rights, obligations and benefits under a purchase agreement made in respect of a strata lot in a development

property, whether the transfer is made by the purchaser under the purchase agreement to another person or is a subsequent transfer.

Each proposed party to an assignment agreement must provide the developer with the information and records required under the *Real Estate Development Marketing Act*.

Before the developer consents to an assignment of a purchase agreement, the developer will be required to collect information and records under the *Real Estate Development Marketing Act* from each proposed party to an assignment agreement, including personal information, respecting the following:

- a) the party's identity;
- b) the party's contact and business information;
- c) the terms of the assignment agreement.

Information and records collected by the developer must be reported by the developer to the administrator designated under the *Property Transfer Tax Act*. The information and records may only be used or disclosed for tax purposes and other purposes authorized by section 20.5 of the *Real Estate Development Marketing Act*, which includes disclosure to the Canada Revenue Agency.

- (o) For greater certainty, the terms and notice set out in subsection 7.2(n), and the inclusion thereof in this section 7.2, do not: (i) constitute consent by the Developer to any assignment of any Purchase Agreement; (ii) obligate the Developer to consent to any assignment of any Purchase Agreement; or (iii) derogate from, diminish, limit, amend, modify or affect the terms and conditions of the Purchase Agreement or the Developer's right to arbitrarily withhold its consent to any assignment of any Purchase Agreement in the Developer's sole and unfettered discretion in accordance with the terms of the Purchase Agreement.
- (p) Intentionally deleted.

7.3 Developer's Commitments

There are no commitments made by the Developer to be met after completion of the sale of the Strata Lots.

7.4 Other Material Facts

(a) *Other Contracts Affecting the Development*

The Developer has not entered into any agreements with respect to the Development other than the agreements described herein. When appropriate to do so, the Developer intends to enter into and cause the Strata Corporation to assume, or cause the Strata Corporation to enter into directly, or cause the Property Manager to enter into on behalf of the Strata Corporation, certain agreements relating to the Development which impose

obligations on the Strata Corporation and/or the purchasers of the Strata Lots including without limitation, some or all of the following agreements:

- (i) agreements the Developer believes are for the benefit of the Strata Corporation, any section thereof, or the Development in general;
- (ii) landscaping and gardening maintenance;
- (iii) window cleaning;
- (iv) elevator servicing;
- (v) fire equipment maintenance;
- (vi) mechanical equipment maintenance;
- (vii) enterphone and security system purchase contract or lease and maintenance thereof;
- (viii) security system lease;
- (ix) garbage collection;
- (x) building envelope maintenance;
- (xi) Security Gate maintenance;
- (xii) storm water management maintenance; and
- (xiii) janitorial and similar services required in connection with the operation and maintenance of the Common Property.

With the exception of the purchase contracts or leases for the enterphone equipment, security system lease and the building envelope maintenance contract, the Developer anticipates that such service contracts will be terminable by the Strata Corporation on not more than three months' notice; however, such service contracts may have longer notice requirements. The estimated costs of such products and services are included in the interim budget for the Strata Corporation attached as Exhibit E-1 to this Disclosure Statement.

Additionally, the Developer intends to enter into and cause the Strata Corporation to assume, or cause the Strata Corporation to enter into directly, or cause the Property Manager to enter into on behalf of the Strata Corporation, some or all of the following agreements:

- (xiv) the Management Contract defined in section 3.10;
- (xv) any unregistered agreements required by the City in order to approve all development, building and occupancy permits required in respect of the development of the Project Lands, the Lands and/or the Development Parcel;
- (xvi) some or all of the agreements set out in sections 4.3 and 4.4; and

- (xvii) crane swing licences, easement agreements and/or reciprocal easements/shoring agreements with respect to the construction of Project Developments.

(b) *Registered Encumbrances*

Except as otherwise expressly described herein, upon the deposit of the Phase 1 Strata Plan in the Land Title Office, the Developer will cause the Strata Corporation to assume all of the obligations and liabilities of the Developer under the legal notations, charges and encumbrances described in sections 4.3 and 4.4 hereof and will cause the Strata Corporation to release the Developer from and indemnify the Developer against any losses suffered by, or claims against, the Developer relating to such legal notations, charges and encumbrances, and, thereafter, the Strata Corporation will be solely responsible for complying with all such obligations. Accordingly, while the descriptions of the legal notations and encumbrances referred to in sections 4.3 and 4.4 hereof contemplate certain obligations of the Developer or the owner of the Lands, the Development Parcel, the Strata Corporation will be responsible for such obligations. Without limiting the generality of the foregoing, the legal notations, charges and encumbrances described in sections 4.3 and 4.4 may include certain ongoing maintenance, repair and payment obligations, and such obligations will be assumed by the Strata Corporation upon the deposit of the Phase 1 Strata Plan in the Land Title Office and the costs and expenses associated with such maintenance, repair and payment will be paid by the Strata Corporation and prorated amongst all the owners of the Strata Lots in accordance with the Unit Entitlements thereof and included in the monthly strata fees.

It is anticipated that, except as otherwise expressly described herein, the legal notations, charges and encumbrances described in sections 4.3 and 4.4 will remain registered against title to the Lands and/or the Development Parcel, the Strata Lots and/or the Common Property following the transfer of the Strata Lots to purchasers. Accordingly, the Development, the Common Property and the Strata Lots, and the use thereof by owners, tenants and occupants of the Strata Lots, will be subject to the restrictions, requirements and obligations set out in legal notations, charges and encumbrances described in sections 4.3 and 4.4 hereof. In the Developer's sole and unfettered discretion, the Developer may, but is not required to, seek to cause certain of the legal notations, charges and encumbrances described in sections 4.3 and 4.4 hereof to be discharged from title to the Lands, the Development Parcel, the Strata Lots or the Common Property prior to or following the transfer of the Strata Lots to purchasers.

(c) *Continuing Sales and Marketing Program*

Following the deposit of the Phase 1 Strata Plan for the Development in the Land Title Office, the Developer will continue to carry out, for such period as the Developer determines to be necessary or desirable in connection with the Development, the Project and/or any future development developed by the Developer or any affiliate of the Developer, marketing, leasing and sales activities within the Common Property, any Limited Common Property amenity areas and any Strata Lots owned or leased by the Developer, including, without limitation, maintaining display suites, other display areas, landscaping and parking areas and permitting public access to the same. The Developer also reserves the right to place signage in and around any unsold Strata Lots and the Common Property and any Limited Common Property amenity areas for the duration of the marketing, leasing and sales program. In addition, the Developer may conduct tours of the Development from time to time with prospective purchasers and

tenants and hold events and other activities within the Development and use such parking areas as are available and other Common Property and Limited Common Property, all as may be required in connection with such marketing, leasing and sales activities.

Following the deposit of the Phase 1 Strata Plan in the Land Title Office, the Developer may elect to cause the Strata Corporation to enter into a licence or other agreement with the Developer (and/or any entity affiliated with the Developer) to confirm the foregoing rights.

The Developer will act reasonably in exercising such rights and will use reasonable efforts to minimize any interference with the use or enjoyment of the Common Property or the Limited Common Property by the Strata Lot owners.

(d) *Views*

Purchasers of Strata Lots are advised that the Developer does not make any representation or warranty as to the views from the Strata Lots and that any simulated views in any brochures, models, blogs, iPads (or other tablets or displays), websites, including the website for the Development, or any other electronic media including any simulated views generated by any computer simulator located in any presentation centre for the Development or any other marketing materials relating to the Development are for illustrative purposes only and should not be relied upon by purchasers of Strata Lots. The completion of the Development and the future development of land adjacent to or in the vicinity of the Development may have a detrimental effect on the views from some or all of the Strata Lots or the amount of natural light that certain Strata Lots might otherwise receive. The Developer does not guarantee that any views from the Strata Lots or the amount of natural light that the Strata Lots might otherwise receive will be preserved and advises potential purchasers of Strata Lots to make their own inquiries, including contacting the City regarding the potential development of land adjacent to or in the vicinity of the Development.

(e) *Non-Traditional Residential Neighbourhood*

The area where the Development will be located may contain, now or in the future, in addition to residential developments, commercial and mixed-use developments. As a result, there is a potential for increased noise and activity, particularly noise and activity (including traffic noise) associated with neighbourhood restaurants and other commercial uses, which might not occur in a wholly residential neighbourhood.

(f) *Variations in Strata Lots*

Purchasers of Strata Lots should be aware that due to the natural variation of colour and texture in the wood, stone, granite, and dye lots of the tile, carpet, countertops and other components of the Strata Lots and the fact that the colour of natural products (especially wood) will change over time, the finishes of the wood, granite, tile, stone, carpet and other components of the Strata Lots may differ from the colour, grain, vein, pattern, size, stain resistance and textures shown in any display unit or any samples provided to or viewed by a purchaser of a Strata Lot. In addition, even within the Strata Lots, the textures, colours and finishes may vary for the same reasons. The variations are inherent characteristics which cannot be fully controlled and any such variations will not in any event be considered or deemed to be deficiencies in the Strata Lots.

The Developer also reserves the right to change the tile, carpet, countertops and other components of the Strata Lots shown in any display unit or in any samples provided to or viewed by the purchaser of a Strata Lot in its sole discretion.

(g) *Community Facilities, Community Association and Cost Sharing*

(i) Project Developments

As described in subsection 2.1(f), the Development forms part of the Project. The EPS4700 Development, the Mackenzie Plaza Development, the Development and the other developments to be constructed upon the Lands in the future are all referred to herein as “**Project Developments**”. Each Project Development is or will be located within a separate legal parcel. Attached as Exhibit L to this Disclosure Statement is a conceptual plan (the “**Proposed Project Plan**”) that shows the anticipated general location, number and order of development of the Project Developments. The Proposed Project Plan is conceptual and preliminary in nature, and is included for illustrative purposes only, and is subject to change in the Developer’s sole discretion or as required by the City, and is not binding upon the Developer in any manner whatsoever. Without limiting the foregoing, the location, number and order of development of the future Project Developments may be different than shown on the Proposed Project Plan, and certain portions of the Project may never be developed.

(ii) Community Facilities

The Development and the other Project Developments will be separate developments and will operate independently, except to the extent required for the purposes of the construction, installation, operation, use, maintenance and repair of Community Facilities. “**Community Facilities**” means all of the following: (1) common facilities, works, areas, utilities, systems, services and improvements located within the Project or which service or benefit the Project that are intended for shared use or benefit of residents of the Project. Portions of the Community Facilities may be located within the Development and, in such case, will form part of the Common Property of the Development.

It is currently anticipated that the only Community Facilities will be the Road System and Trail System (each as defined below) and, possibly, the Bus Service (as defined below).

The Developer and/or the Community Association may (but is not required to) arrange for or cause there to be other Community Facilities.

(iii) Road System and Trail System

The Project is intended to include a common internal road system (the “**Road System**”) and a common internal pedestrian trail system (the “**Trail System**”). The Road System and the Trail System will be constructed incrementally on portions of the Lands as those portions are created and developed. The anticipated location of the Road System and the Trail System is shown on the Proposed Project Plan, provided that the location is subject to change in the Developer’s sole discretion or as required by the City.

It is currently anticipated that the Road System and the Trail System will not be dedicated as road or parkland, and, instead, will be located on private property. In particular, it is intended that portions of the Road System and the Trail System will form part of the Development and will be designated as Common Property on the Strata Plan.

In addition to being used by residents of the Project, the Road System and the Trail System (including the portions thereof which form part of the Development) are intended to be used by the general public. Accordingly, as contemplated in the Master Development Agreement, it is anticipated that the City will require statutory rights of way (collectively, the “**Road and Trail System Public SRW**”) to be granted in favour of the City pursuant to section 218 of the *Land Title Act* over the Lands which allow the general public to access and use the Road System and the Trail System, including those portions of the Road System and the Trail System located within the Development.

Although the owners and occupants of the Strata Lots and the other Project Developments will have the right to access and use the Road System and the Trail System as members of the public pursuant to the Road and Trail System Public SRW, the Road and Trail System Community Association SRW Agreement (as defined and described in paragraph 4.3(b)(xxi)) also provides for, *inter alia*, private access and use rights over the Road System and the Trail System.

(iv) Bus Service

It is anticipated that the Community Facilities will include a bus service (the “**Bus Service**”) for the owners and occupants of the Strata Lots and the other Project Developments, to operate between the Project and certain nearby amenities, such as, for example, Revelstoke Mountain Resort. The frequency, route(s), destination(s) and cost of the Bus Service have not yet been determined at this time, and are subject to change from time to time. The Bus Service may never be included as part of the Community Facilities, and/or may be discontinued at any time.

The Community Association may operate the Bus Service, or the Bus Service may be operated by a third party and contributed to financially by the Community Association. The Strata Corporation will be responsible for paying to the Community Association the Strata Corporation’s applicable share of the costs and expenses incurred by the Community Association in connection with the Bus Service. Upon the formation of the Strata Corporation, the Developer may cause the Strata Corporation to enter into an agreement with the Community Association whereby the Strata Corporation agrees to pay its share of such costs and expenses.

(v) Community Association

The Mackenzie Village Community Association (the “**Community Association**”) was incorporated under the *Societies Act* (British Columbia) on November 10, 2022. A copy of the Community Association’s bylaws are attached as Exhibit N hereto.

The Community Association is responsible for the operation, maintenance and repair of the portions of the Road System and the Trail System located on land owned or controlled by its members (being, as of the date hereof, the Lands and the Mackenzie Plaza Development Lands). It is anticipated that the Community Association will also operate or contribute financially towards the Bus Service. The Community Association may also, in the future, assume responsibility for other Community Facilities.

Currently, the Developer is the only member of the Community Association. Upon the deposit of the Strata Plan in the Land Title Office, the Strata Corporation will become a member of the Community Association. In addition, (A) the strata corporation for the Mackenzie Plaza Development Lands will become a member of the Community Association upon the creation of such strata corporation; and (B) the strata corporations formed in respect of other Project Developments that are developed on the Lands from time to time will become members of the Community Association, upon the formation of each such strata corporation.

The Developer currently intends to retain all voting control and decision-making authority of the Community Association until such time as the Project is complete. After completion of the Project, the members of the Community Association (including the Strata Corporation) will be responsible for making decisions with respect to the affairs and duties of the Community Association in accordance with its bylaws.

(vi) Community Association Agreements

The Community Association has been designated to hold the benefit of statutory rights of way and section 219 covenants pursuant to the *Land Title Act*.

The Developer has granted the Road and Trail System Community Association SRW Agreement (as defined and described in paragraph 4.3(b)(xxi)) in favour of the Community Association. The Road and Trail System Community Association SRW Agreement is a statutory right of way over the Mackenzie Plaza Development Lands and the Lands, in order to provide the Community Association with the right to access the Road System and the Trail System on the Mackenzie Plaza Development Lands and the Lands in order to maintain and repair the Road System and the Trail System, and to provide the Community Association with right to use (and permit its members and their residents to use) the Road System and the Trail System on the Mackenzie Plaza Development Lands and the Lands. As the Mackenzie Plaza Development Lands and the Lands are subdivided and developed over time, it is intended that the Road and Trail System Community Association SRW Agreement will be partially discharged from time to time so that it charges only those portions of the applicable parcel on which the Road System and the Trail System are located. The Developer will cause the Strata Corporation, upon its formation, to assume the Developer's obligations under the Road and Trail System Community Association SRW Agreement with respect to the Development Parcel.

The Developer may, from time to time, grant additional statutory rights of way, section 219 covenants and other charges in favour of the Community Association over the Lands in connection with the Community Facilities (collectively, the **"Other Community Facilities Charges"**).

(vii) Cost-Sharing

Costs and expenses incurred by the Community Association in operating, maintaining and repairing the Community Facilities (including, without limitation, the Road System and the Trail System) (collectively, the “**Community Association Shared Costs**”) will be shared by the members of the Community Association (other than the Developer) pursuant to and in accordance with the bylaws of the Community Association. As described more particularly in the bylaws of the Community Association, the Community Association Shared Costs will be shared based on the ratio of (1) the habitable area of all buildings constructed within a given member’s Project Development to (2) the habitable area of all buildings constructed within all members’ Project Developments. The Community Association may, in future, alter the cost sharing formula if, after further analysis, a different cost sharing allocation mechanism is determined to be more equitable or otherwise appropriate. The Developer may also cause the Strata Corporation, upon its formation, to enter into one or more separate stand-alone agreements, in such form and containing such terms and conditions as the Developer may determine in its sole discretion (collectively, the “**Community Association Cost Sharing Agreements**”) to give effect to cost-sharing obligations relating to the Community Association Shared Costs.

The Strata Corporation will be required to pay its share of the Community Association Shared Costs to the Community Association from time to time in accordance with the bylaws of the Community Association. The portion of the Community Association Shared Costs for which the Strata Corporation is responsible will form part of the Strata Corporation’s budget and will be shared by the owners of the Strata Lots on the basis of the Unit Entitlement of the Strata Lots and will be included in the owners’ monthly assessments.

The budget of estimated operating expenses set out in Exhibit E-1 to this Disclosure Statement includes an estimate of the Strata Corporation’s initial estimated share of the Community Association Shared Costs, to the extent such costs are known at the date of this Disclosure Statement. In particular, such estimated share includes Community Association Shared Costs relating to the Road System, the Trail System and the Bus Service. The Community Association Shared Costs are anticipated to increase as Project Developments are developed from time to time.

The Developer will pay the share of the Community Association Shared Costs attributable to the Phase 2 Strata Lots, until such time as the Phase 2 Strata Plan is filed (following which, the share of the Community Association Shared Costs attributable to the Phase 2 Strata Lots will be paid by the Strata Corporation and the cost will be allocated to the owners of the Strata Lots in accordance with the Unit Entitlement thereof and included in the monthly assessments). Except for the foregoing, the Developer will not be responsible for any portion of the Community Association Shared Costs.

(viii) EPS4700 Development

The strata corporation for the EPS4700 Development (the “**EPS4700 Strata Corporation**”) is not currently a member of the Community Association. The EPS4700 Strata Corporation may in the future become a member of the Community Association, or may never become a member of the Community

Association. Unless and until the EPS4700 Strata Corporation becomes a member of the Community Association, the Community Association will not be responsible for operating, maintaining or repairing the portion of the Road System or the Trail System located on the EPS4700 Lands, and the EPS4700 Strata Corporation will not be required to contribute towards the costs and expenses incurred by the Community Association. If the EPS4700 Strata Corporation becomes a member of the Community Association, then the Community Association will thereafter be responsible for operating, maintaining or repairing the portion of the Road System or the Trail System located on the EPS4700 Lands, and it anticipated that the Community Association will enter into a statutory right of way agreement, or other agreement(s), to give effect to the foregoing. For greater certainty, the Road and Trail System Community Association SRW Agreement does not apply to the EPS4700 Lands.

(ix) **Changes and Project Easements**

This subsection 7.4(g) describes the Developer's intended approach to dealing with the Community Facilities. However, the Developer reserves the right to make changes to any of the matters contemplated in this subsection 7.4(g), and the City may also require the Developer to make changes to the matters contemplated in this subsection 7.4(g).

In particular, but without limiting the foregoing, the Developer may also grant easements over the Development Parcel in favour of other portions of the Project Lands, and accept the benefit of easements in favour of the Development Parcel over other portions of the Project Lands, in order to provide for some or all of the rights or obligations described in this subsection 7.4(g). Also, if permitted or required by the City, the Road System and the Trail System (or portions thereof) may be dedicated, rather than being located on private property. The Developer also intends to grant easements over the Development Parcel in favour of other portions of the Project Lands that are still owned by the Developer in order to permit the construction of remaining portions of the Project. The easements described in this subsection 7.4(g) are referred to herein as the "**Project Easements**".

(h) ***Construction of the Parking Facility***

The Developer anticipates constructing that portion of the Parking Facility located within Phase 1 at the same time that the Buildings located in Phase 1 are constructed, and constructing that portion of the Parking Facility located within Phase 2 at the same time that the Buildings located in Phase 2 are constructed. As such, owners and occupants of the Strata Lots will not be able to access or use that portion of the Parking Facility located in Phase 2, including, without limitation, the Parking Stalls located therein, unless and until construction of Phase 2 is completed. During the construction of Phase 2, including, without limitation, that portion of the Parking Facility located within Phase 2, owners and occupants of the Strata Lots may be temporarily unable to access or use certain portions of the common property located in Phase 1, including, without limitation, certain of the Parking Stalls located in Phase 1.

DEEMED RELIANCE

Section 22 of the *Real Estate Development Marketing Act* (British Columbia) provides that every purchaser who is entitled to receive this Disclosure Statement is deemed to have relied on any false or misleading statement of a material fact contained in this Disclosure Statement, if any, and any omission to state a material fact. The Developer, its directors and any person who has signed or authorized the filing of this Disclosure Statement are liable to compensate the purchaser for any misrepresentation, subject to any defences available under section 22 of the *Real Estate Development Marketing Act* (British Columbia).

DECLARATION

The foregoing statements disclose, without misrepresentation, all material facts relating to the Development referred to above, as required by the *Real Estate Development Marketing Act* (British Columbia), as of the 30th day of August, 2023.

DEVELOPER

0929468 B.C. LTD.

By: 

Authorized Signatory

By: _____
Authorized Signatory

DIRECTORS OF 0929468 B.C. LTD.

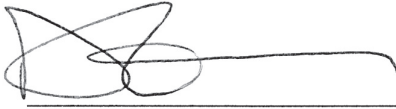

DAVID EVANS



SHELLEY ANNE EVANS

EXHIBITS TO THIS DISCLOSURE STATEMENT

- Exhibit A-1 - Preliminary Plan – Phase 1
- Exhibit B - Form P - Phased Strata Plan Declaration
- Exhibit C-1 - Proposed Form V – Schedule of Estimated Unit Entitlement – Phase 1
- Exhibit D - Proposed Form Y – Notice of Different Bylaws
- Exhibit E-1 - Proposed Interim Budget of Operating Expenses – Phase 1
- Exhibit F - Cumulative Budgets of Operating Expenses for Phases 1 – 2 (for illustrative purposes only)
- Exhibit G-1 - Estimated Monthly Assessments – Phase 1
- Exhibit H - Estimated Cumulative Assessments for Phases 1 – 2 (for illustrative purposes only)
- Exhibit I - Proposed Form of Purchase Agreement – Phase 1
- Exhibit J - Parking and Storage Lease
- Exhibit K - Subdivision Plan
- Exhibit L - Proposed Project Plan
- Exhibit M - Intentionally Deleted
- Exhibit N - Mackenzie Village Community Association Bylaws

EXHIBIT A-1
PRELIMINARY PLAN – PHASE 1

See attached.

**PLAN TO ACCOMPANY DISCLOSURE
STATEMENT ON PART OF LOT B
SECTION 23 TOWNSHIP 23 RANGE 2
WEST OF THE 6TH MERIDIAN
KOOTENAY DISTRICT PLAN EPP125979
(Pending Registration)**

Sheet 1 of 19 Sheets

**PRE-STRATA PLAN
PHASE 1**

BCGS 82L.100



The intended plot size of this plan is 432mm in width by 280mm in height (B size) when plotted at a scale of 1:1500.

LEGEND

SL denotes Strata Lot

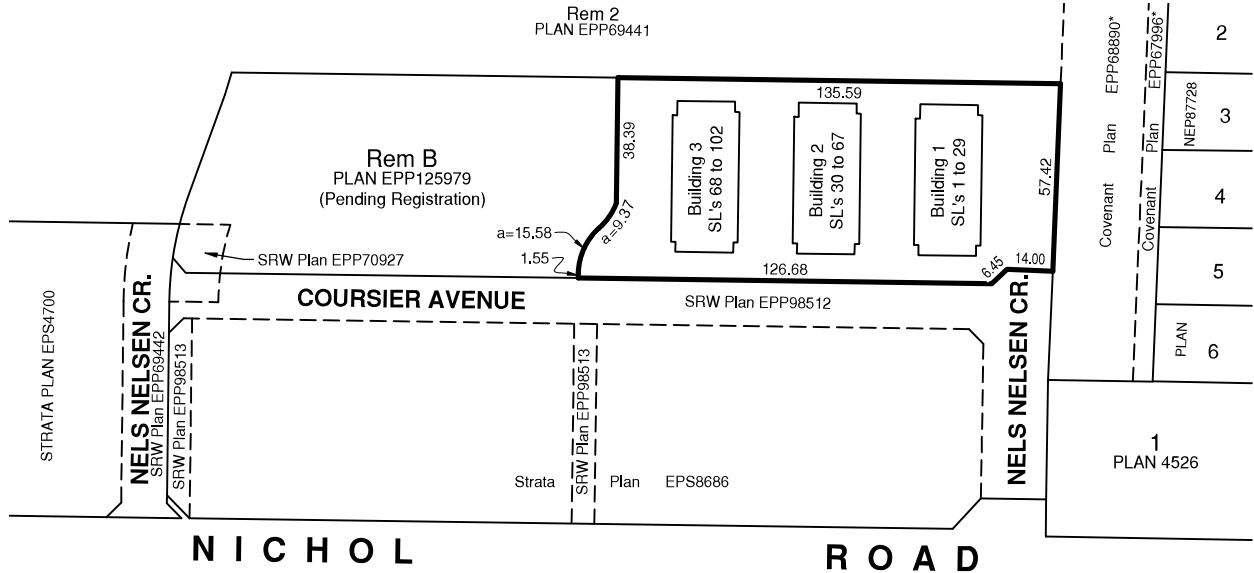

Project Name:
The Selkirks at MacKenzie Village

Civic Address:
Nichol Road, Revelstoke, BC

Architectural plans provided by Stark Architecture on July 16th, 2023.

Strata lot boundaries are defined by the centreline of the structural portion of walls.

Limited Common Property boundaries are approximate and are subject to change upon completion of construction.

All private gardens and balconies are defined as to height by the centre of the floor above, or its extensions or where there is no floor above by the average height of a strata lot within the same building unless otherwise indicated.

This plan lies within the Columbia Shuswap Regional District and the City of Revelstoke

I, Anna Niraz, a British Columbia land surveyor, hereby certify that the information contained within this plan substantially complies with architectural plans for the above noted development.

Dated this 1st day of August, 2023

Anna Niraz Digitally signed by
Anna Niraz VI9T5V
VI9T5V Date: 2023.08.03
16:23:17 -07'00'

Anna Niraz

BCLS 964



202 - 1475 Ellis Street
Kelowna, BC

PROJECT REF./DRAWING No.
22-03760-001-DSC01-R2

Plotted: 8/3/2023 10:40 AM User: KarlaHerrera

PARKADE LEVEL

PRE-STRATA PLAN PHASE 1



The intended plot size of this plan is 432mm in width by 280mm in height (B size) when plotted at a scale of 1:500.



LEGEND

- ⊙ denotes Common Property
- Elec denotes electrical room
- H/C denotes handicapped
- Mech denotes mechanical room
- Vest denotes vestibule

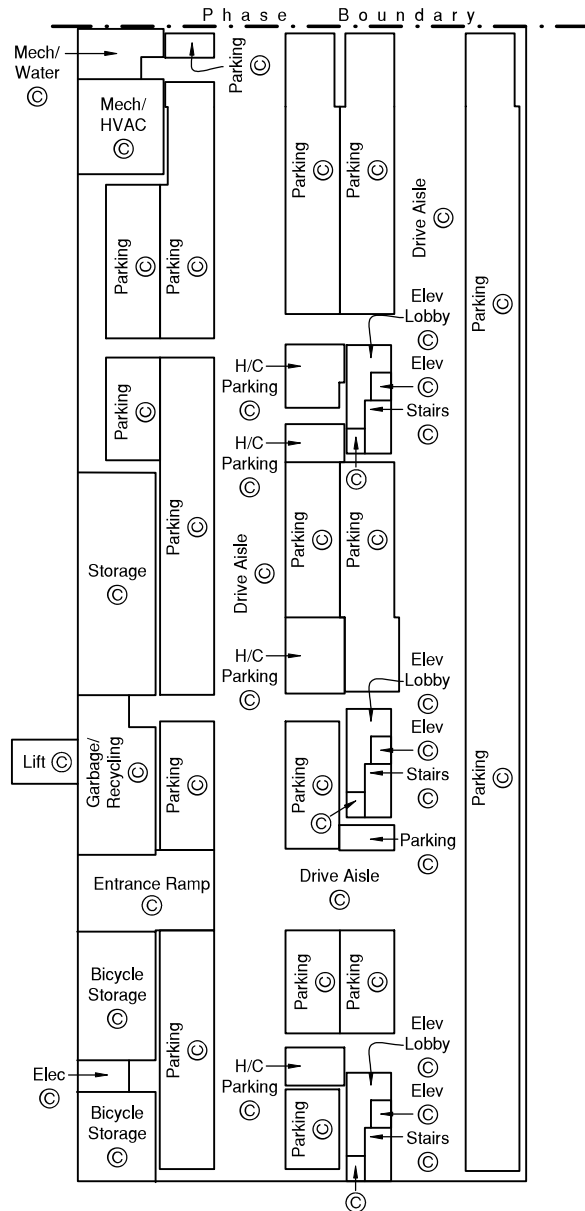

Plotted: 8/3/2023 10:40 AM User: Karla Herrera



202 - 1475 Ellis Street
Kelowna, BC

PROJECT REF./DRAWING No.
22-03760-001-DSC01-R2

BUILDING 1 - LEVEL 1 PART SL'S 1 TO 13 INCLUSIVE

Sheet 3 of 19 Sheets

PRE-STRATA PLAN PHASE 1



The intended plot size of this plan is 432mm in width by 280mm in height (B size) when plotted at a scale of 1:200.

LEGEND

- SL denotes Strata Lot
- ⊙ denotes Common Property
- LCP denotes Limited Common property for the Exclusive Use of Designated Strata Lot
- Mech denotes mechanic room
- Elev denotes elevator
- Vest denotes vestibule

Areas of Limited Common Property (Private Gardens and Balconies) lower/upper vertical extent are defined by the centre of the floor below/above or its extensions, or where there is no floor below/above, by the average height of a strata lot within the same building unless otherwise indicated.

Method of Measurement:

- Midpoint of structural portion of exterior walls
- Midpoint of structural portion of demising walls between strata lots

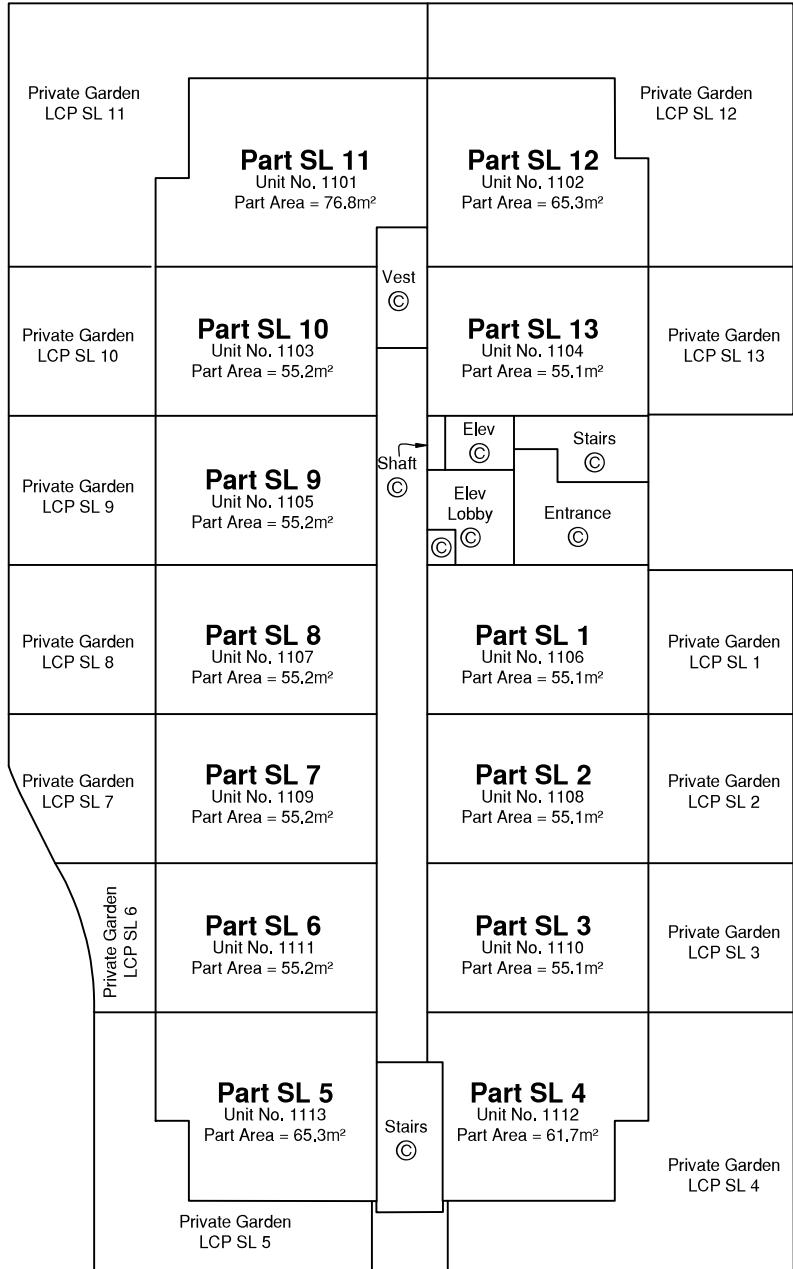

Plotted: 8/3/2023 10:40 AM User: Karla Herrera



202 - 1475 Ellis Street
Kelowna, BC

PROJECT REF./DRAWING No.
22-03760-001-DSC01-R2

BUILDING 1 - LEVEL 2 PART SL'S 1 TO 13 INCLUSIVE

Sheet 4 of 19 Sheets

PRE-STRATA PLAN PHASE 1



The intended plot size of this plan is 432mm in width by 280mm in height (B size) when plotted at a scale of 1:200.

LEGEND

- SL denotes Strata Lot
- ⊙ denotes Common Property
- LCP denotes Limited Common property for the Exclusive Use of Designated Strata Lot
- Mech denotes mechanic room
- Elev denotes elevator
- Vest denotes vestibule

Areas of Limited Common Property (Private Gardens and Balconies) lower/upper vertical extent are defined by the centre of the floor below/above or its extensions, or where there is no floor below/above, by the average height of a strata lot within the same building unless otherwise indicated.

Method of Measurement:

- Midpoint of structural portion of exterior walls
- Midpoint of structural portion of demising walls between strata lots

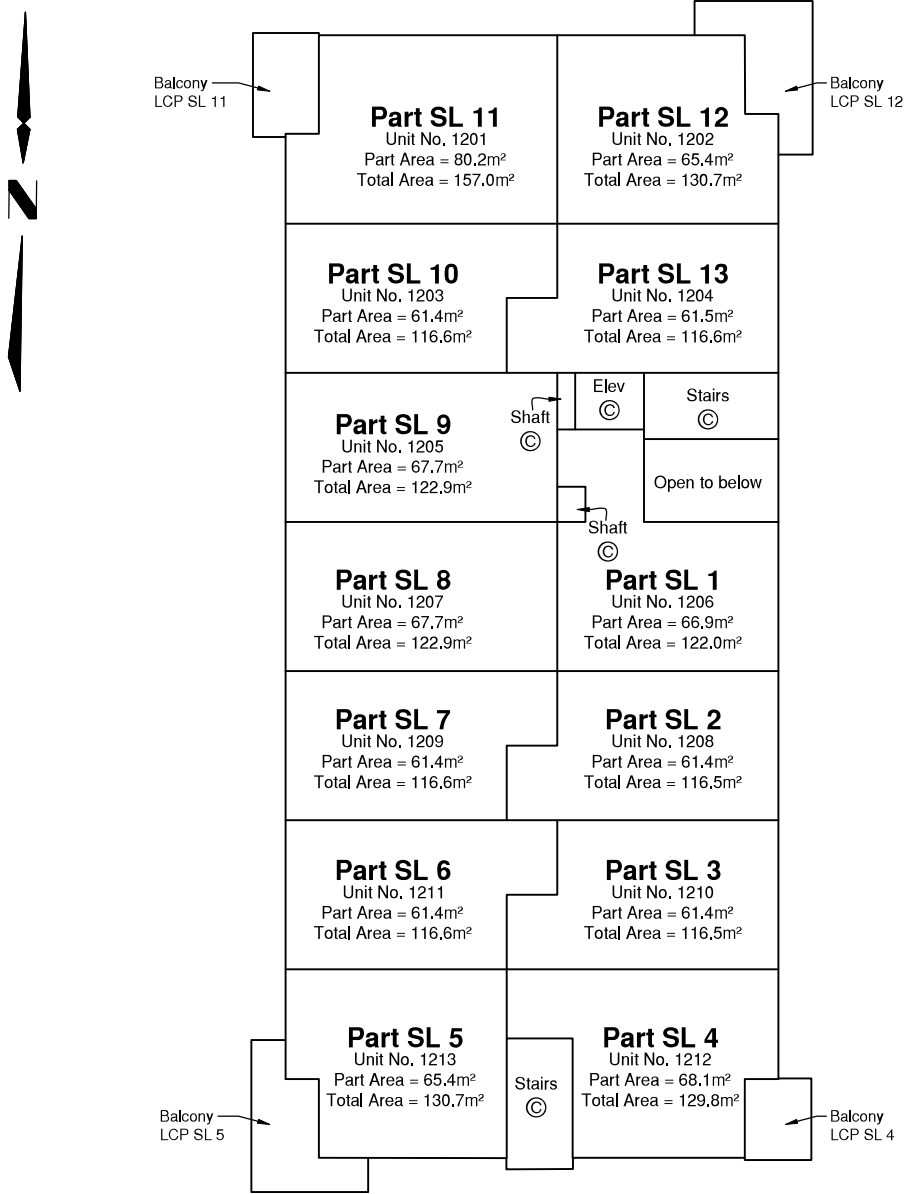

Plotted: 8/3/2023 10:40 AM User: Karla Herrera

GeoVerra
202 - 1475 Ellis Street
Kelowna, BC
PROJECT REF./DRAWING No.
22-03760-001-DSC01-R2

BUILDING 1 - LEVEL 3 SL'S 14 TO 21 INCLUSIVE

Sheet 5 of 19 Sheets

PRE-STRATA PLAN PHASE 1



The intended plot size of this plan is 432mm in width by 280mm in height (B size) when plotted at a scale of 1:200.

LEGEND

- SL denotes Strata Lot
- ⊙ denotes Common Property
- LCP denotes Limited Common property for the Exclusive Use of Designated Strata Lot
- Mech denotes mechanic room
- Elev denotes elevator
- Vest denotes vestibule

Areas of Limited Common Property (Private Gardens and Balconies) lower/upper vertical extent are defined by the centre of the floor below/above or its extensions, or where there is no floor below/above, by the average height of a strata lot within the same building unless otherwise indicated.

Method of Measurement:

- Midpoint of structural portion of exterior walls
- Midpoint of structural portion of demising walls between strata lots

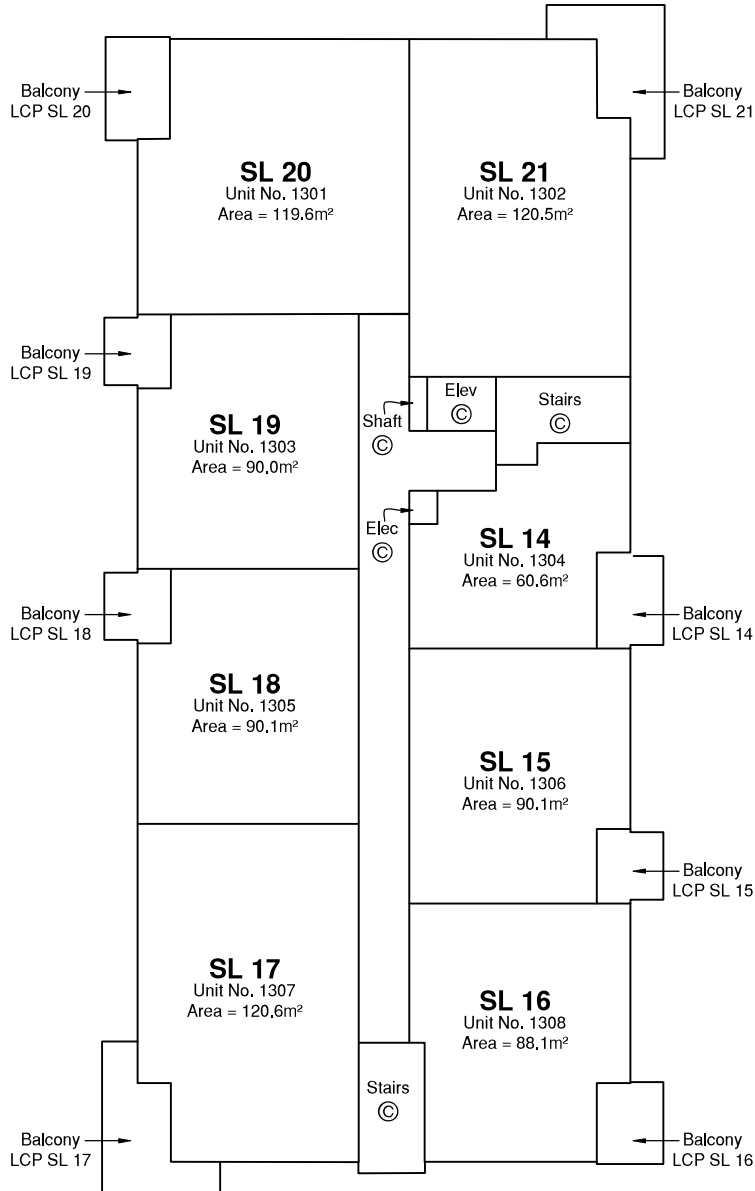

Plotted: 8/3/2023 10:40 AM User: Karla Herrera



202 - 1475 Ellis Street
Kelowna, BC

PROJECT REF./DRAWING No.
22-03760-001-DSC01-R2

BUILDING 1 - LEVEL 4 SL'S 22 TO 29 INCLUSIVE

Sheet 6 of 19 Sheets

PRE-STRATA PLAN PHASE 1



The intended plot size of this plan is 432mm in width by 280mm in height (B size) when plotted at a scale of 1:200.

LEGEND

- SL denotes Strata Lot
- ⊙ denotes Common Property
- LCP denotes Limited Common property for the Exclusive Use of Designated Strata Lot
- Mech denotes mechanic room
- Elev denotes elevator
- Vest denotes vestibule

Areas of Limited Common Property (Private Gardens and Balconies) lower/upper vertical extent are defined by the centre of the floor below/above or its extensions, or where there is no floor below/above, by the average height of a strata lot within the same building unless otherwise indicated.

Method of Measurement:

- Midpoint of structural portion of exterior walls
- Midpoint of structural portion of demising walls between strata lots

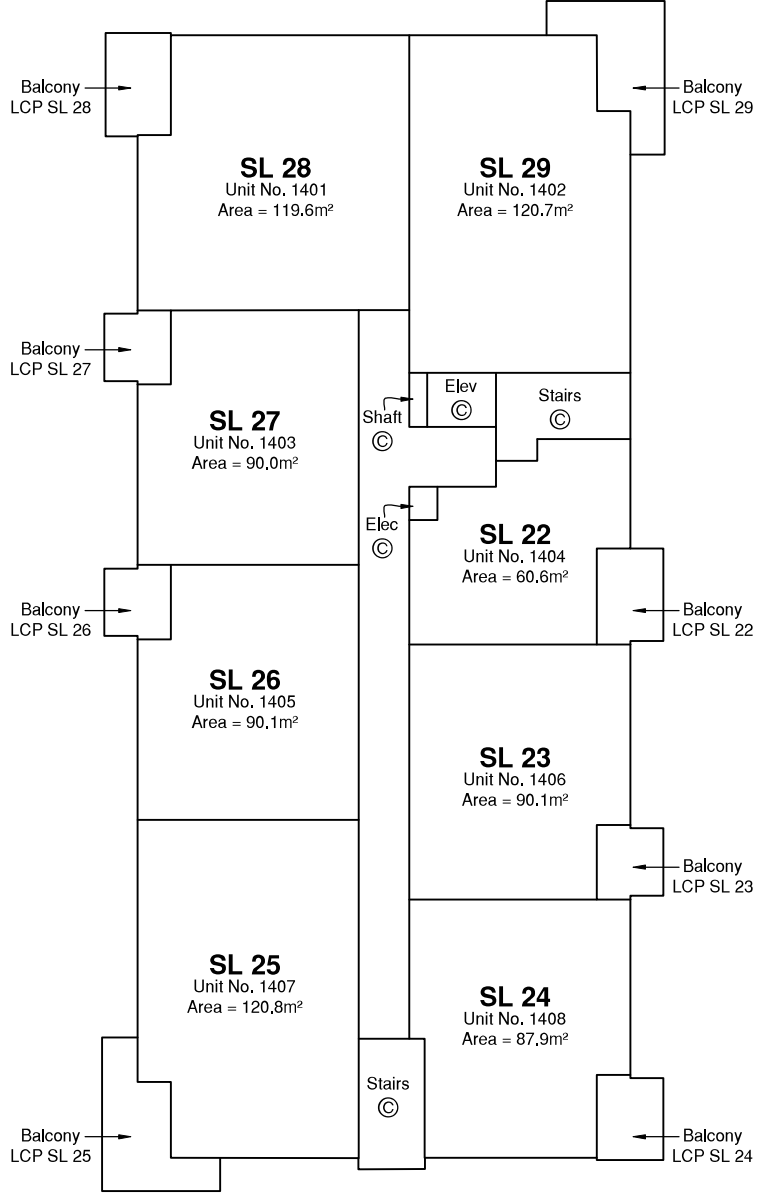

Plotted: 8/3/2023 10:40 AM User: Karla Herrera



202 - 1475 Ellis Street
Kelowna, BC

PROJECT REF./DRAWING No.
22-03760-001-DSC01-R2

Anna Niraz, BCLS 964
August 1st, 2023

BUILDING 1 - ROOF LEVEL

Sheet 7 of 19 Sheets

PRE-STRATA PLAN PHASE 1



The intended plot size of this plan is 432mm in width by 280mm in height (B size) when plotted at a scale of 1:200.

LEGEND

- SL denotes Strata Lot
- ⊙ denotes Common Property
- LCP denotes Limited Common property for the Exclusive Use of Designated Strata Lot
- Mech denotes mechanic room
- Elev denotes elevator
- Vest denotes vestibule

Areas of Limited Common Property (Private Gardens and Balconies) lower/upper vertical extent are defined by the centre of the floor below/above or its extensions, or where there is no floor below/above, by the average height of a strata lot within the same building unless otherwise indicated.

Method of Measurement:

- Midpoint of structural portion of exterior walls
- Midpoint of structural portion of demising walls between strata lots

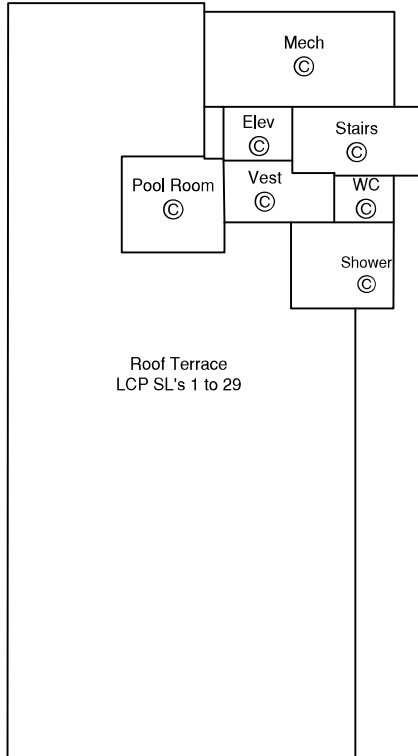

Plotted: 8/3/2023 10:40 AM User: Karla Herrera



202 - 1475 Ellis Street
Kelowna, BC

PROJECT REF./DRAWING No.
22-03760-001-DSC01-R2

Anna Niraz, BCLS 964
August 1st, 2023

BUILDING 2 - LEVEL 1 SL'S 30 TO 37 INCLUSIVE

Sheet 8 of 19 Sheets

PRE-STRATA PLAN PHASE 1



The intended plot size of this plan is 432mm in width by 280mm in height (B size) when plotted at a scale of 1:200.

LEGEND

- SL denotes Strata Lot
- ⊙ denotes Common Property
- LCP denotes Limited Common property for the Exclusive Use of Designated Strata Lot
- Mech denotes mechanic room
- Elev denotes elevator
- Vest denotes vestibule

Areas of Limited Common Property (Private Gardens and Balconies) lower/upper vertical extent are defined by the centre of the floor below/above or its extensions, or where there is no floor below/above, by the average height of a strata lot within the same building unless otherwise indicated.

Method of Measurement:

- Midpoint of structural portion of exterior walls
- Midpoint of structural portion of demising walls between strata lots

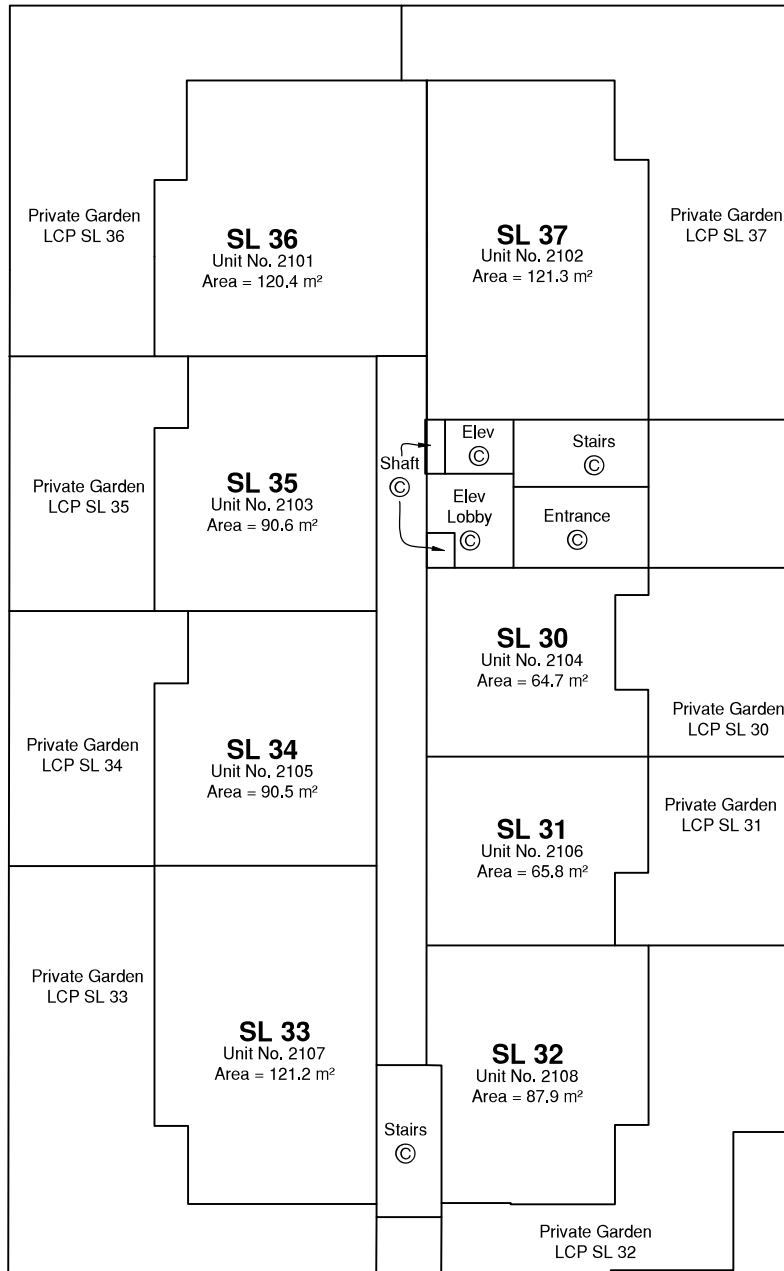

Plotted: 8/3/2023 10:40 AM User: Karla Herrera



202 - 1475 Ellis Street
Kelowna, BC

PROJECT REF./DRAWING No.
22-03760-001-DSC01-R2

Anna Niraz, BCLS 964
August 1st, 2023

BUILDING 2 - LEVEL 2 SL'S 38 TO 45 INCLUSIVE

PRE-STRATA PLAN PHASE 1



The intended plot size of this plan is 432mm in width by 280mm in height (B size) when plotted at a scale of 1:200.

LEGEND

- SL denotes Strata Lot
- ⊙ denotes Common Property
- LCP denotes Limited Common property for the Exclusive Use of Designated Strata Lot
- Mech denotes mechanic room
- Elev denotes elevator
- Vest denotes vestibule

Areas of Limited Common Property (Private Gardens and Balconies) lower/upper vertical extent are defined by the centre of the floor below/above or its extensions, or where there is no floor below/above, by the average height of a strata lot within the same building unless otherwise indicated.

Method of Measurement:

- Midpoint of structural portion of exterior walls
- Midpoint of structural portion of demising walls between strata lots

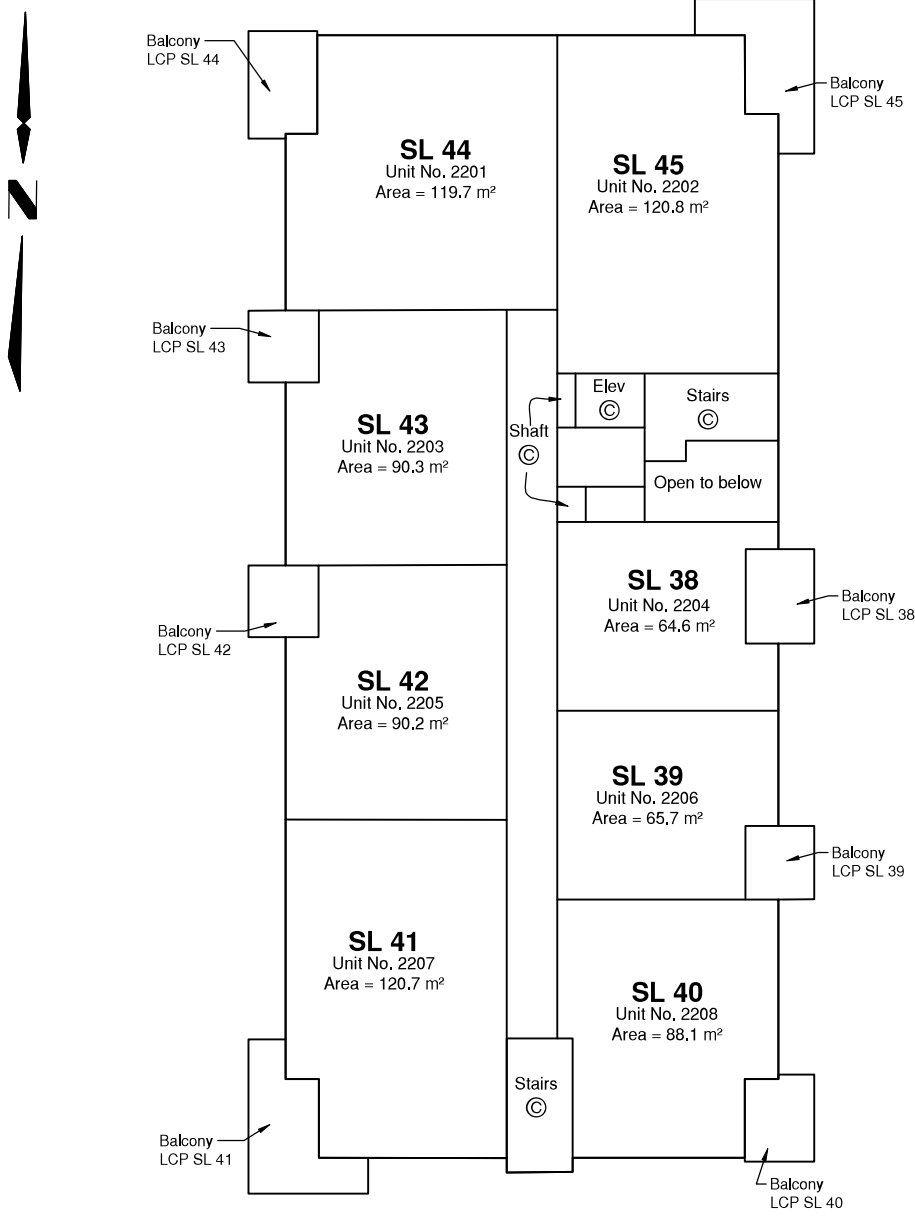

Plotted: 8/3/2023 10:40 AM User: Karla Herrera



202 - 1475 Ellis Street
Kelowna, BC

PROJECT REF./DRAWING No.
22-03760-001-DSC01-R2

BUILDING 2 - LEVEL 3 SL'S 46 TO 53 INCLUSIVE

PRE-STRATA PLAN PHASE 1



The intended plot size of this plan is 432mm in width by 280mm in height (B size) when plotted at a scale of 1:200.

LEGEND

- SL denotes Strata Lot
- ⊙ denotes Common Property
- LCP denotes Limited Common property for the Exclusive Use of Designated Strata Lot
- Mech denotes mechanic room
- Elev denotes elevator
- Vest denotes vestibule

Areas of Limited Common Property (Private Gardens and Balconies) lower/upper vertical extent are defined by the centre of the floor below/above or its extensions, or where there is no floor below/above, by the average height of a strata lot within the same building unless otherwise indicated.

Method of Measurement:

- Midpoint of structural portion of exterior walls
- Midpoint of structural portion of demising walls between strata lots

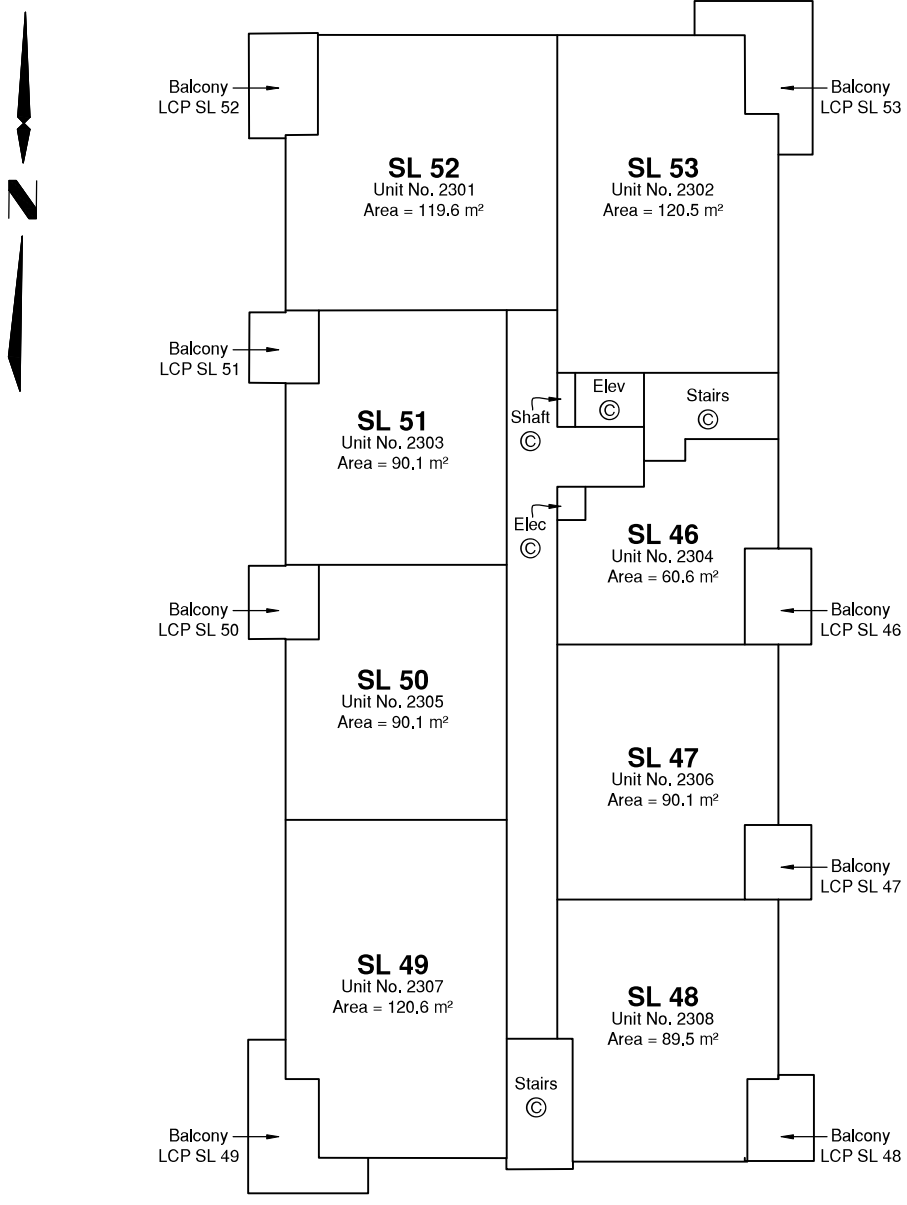

Plotted: 8/3/2023 10:40 AM User: Karla Herrera

GeoVerra
 202 - 1475 Ellis Street
 Kelowna, BC
 PROJECT REF./DRAWING No.
 22-03760-001-DSC01-R2

BUILDING 2 - LEVEL 4 SL'S 54 TO 61 INCLUSIVE

PRE-STRATA PLAN PHASE 1



The intended plot size of this plan is 432mm in width by 280mm in height (B size) when plotted at a scale of 1:200.

LEGEND

- SL denotes Strata Lot
- ⊙ denotes Common Property
- LCP denotes Limited Common property for the Exclusive Use of Designated Strata Lot
- Mech denotes mechanic room
- Elev denotes elevator
- Vest denotes vestibule

Areas of Limited Common Property (Private Gardens and Balconies) lower/upper vertical extent are defined by the centre of the floor below/above or its extensions, or where there is no floor below/above, by the average height of a strata lot within the same building unless otherwise indicated.

Method of Measurement:

- Midpoint of structural portion of exterior walls
- Midpoint of structural portion of demising walls between strata lots

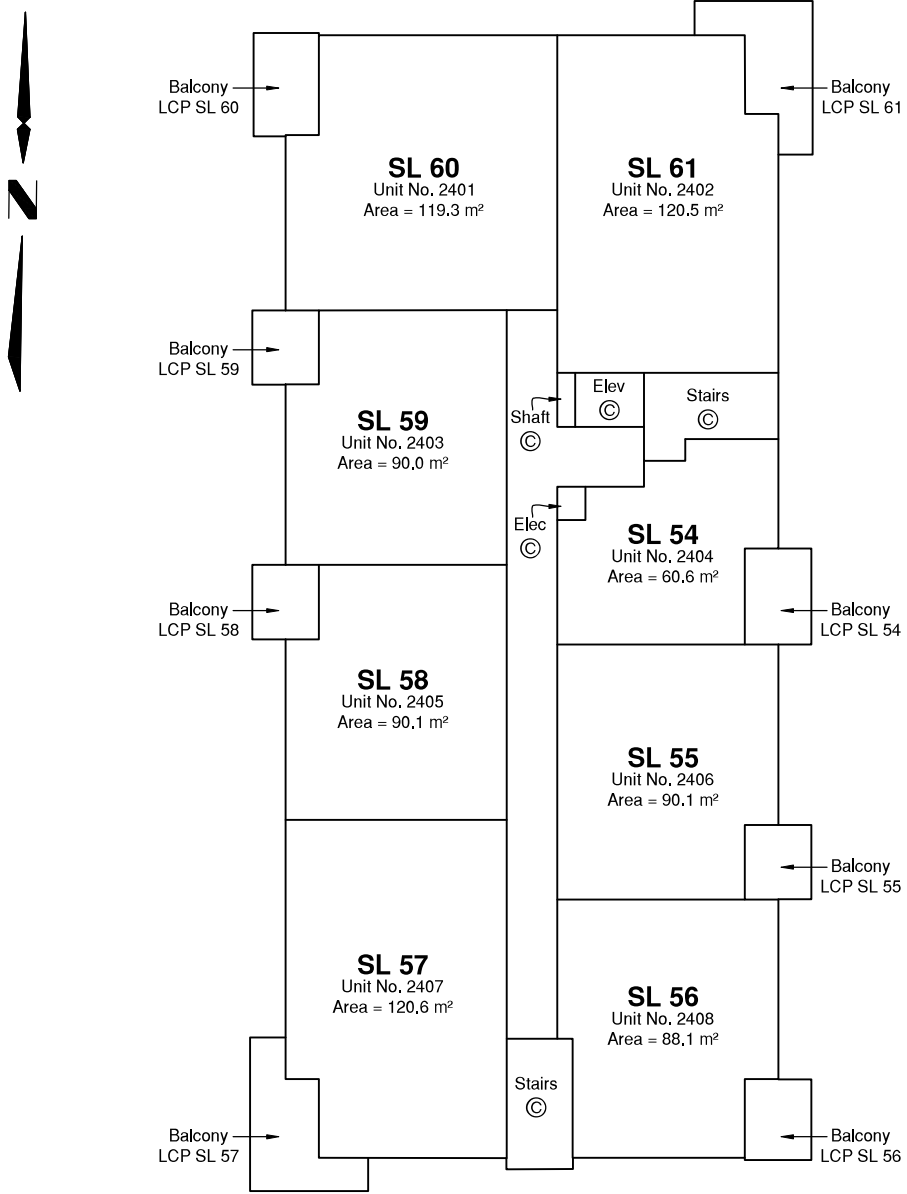

Plotted: 8/3/2023 10:40 AM User: Karla Herrera



202 - 1475 Ellis Street
Kelowna, BC

PROJECT REF./DRAWING No.
22-03760-001-DSC01-R2

BUILDING 2 - LEVEL 5 SL'S 62 TO 67 INCLUSIVE

Sheet 12 of 19 Sheets

PRE-STRATA PLAN PHASE 1



The intended plot size of this plan is 432mm in width by 280mm in height (B size) when plotted at a scale of 1:200.

LEGEND

- SL denotes Strata Lot
- ⊙ denotes Common Property
- LCP denotes Limited Common property for the Exclusive Use of Designated Strata Lot
- Mech denotes mechanic room
- Elev denotes elevator
- Vest denotes vestibule

Areas of Limited Common Property (Private Gardens and Balconies) lower/upper vertical extent are defined by the centre of the floor below/above or its extensions, or where there is no floor below/above, by the average height of a strata lot within the same building unless otherwise indicated.

Method of Measurement:

- Midpoint of structural portion of exterior walls
- Midpoint of structural portion of demising walls between strata lots

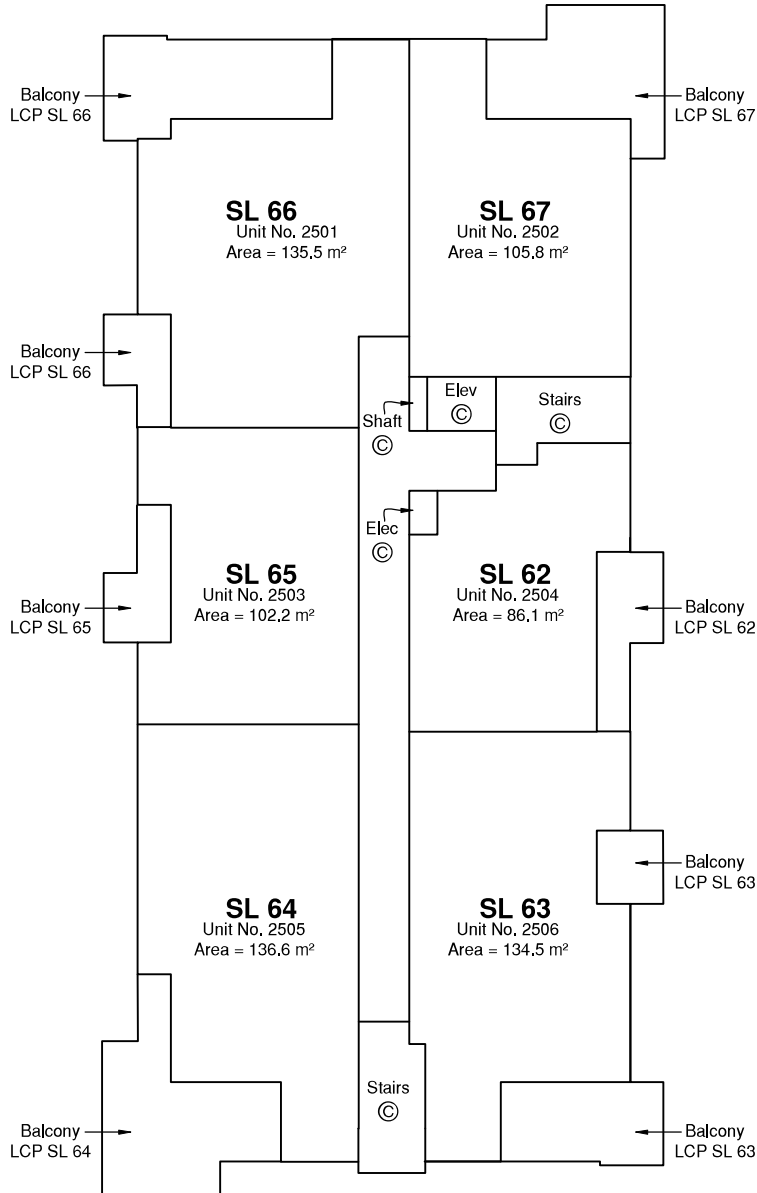

Plotted: 8/3/2023 10:40 AM User: Karla Herrera



202 - 1475 Ellis Street
Kelowna, BC

PROJECT REF./DRAWING No.
22-03760-001-DSC01-R2

Anna Niraz, BCLS 964
August 1st, 2023

BUILDING 2 - ROOF LEVEL

Sheet 13 of 19 Sheets

PRE-STRATA PLAN PHASE 1



The intended plot size of this plan is 432mm in width by 280mm in height (B size) when plotted at a scale of 1:200.

LEGEND

- SL denotes Strata Lot
- ⊙ denotes Common Property
- LCP denotes Limited Common property for the Exclusive Use of Designated Strata Lot
- Mech denotes mechanic room
- Elev denotes elevator
- Vest denotes vestibule

Areas of Limited Common Property (Private Gardens and Balconies) lower/upper vertical extent are defined by the centre of the floor below/above or its extensions, or where there is no floor below/above, by the average height of a strata lot within the same building unless otherwise indicated.

Method of Measurement:

- Midpoint of structural portion of exterior walls
- Midpoint of structural portion of demising walls between strata lots

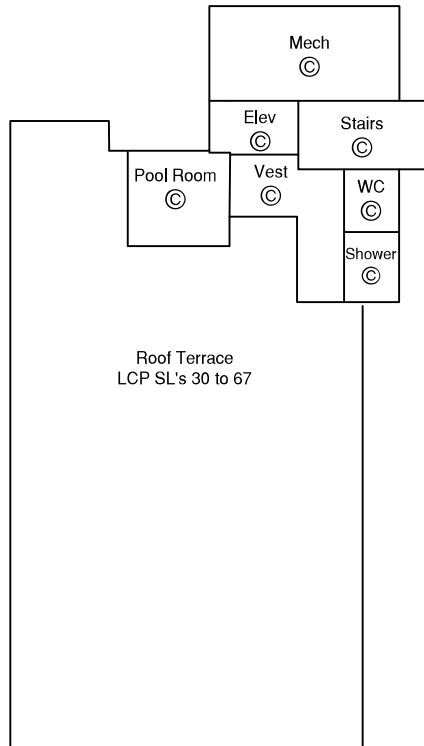

Plotted: 8/3/2023 10:40 AM User: Karla Herrera



202 - 1475 Ellis Street
Kelowna, BC

PROJECT REF./DRAWING No.
22-03760-001-DSC01-R2

Anna Niraz, BCLS 964
August 1st, 2023

BUILDING 3 - LEVEL 1 PART SL'S 68 TO 80 INCLUSIVE

Sheet 14 of 19 Sheets

PRE-STRATA PLAN PHASE 1



The intended plot size of this plan is 432mm in width by 280mm in height (B size) when plotted at a scale of 1:200.

LEGEND

- SL denotes Strata Lot
- ⊙ denotes Common Property
- LCP denotes Limited Common property for the Exclusive Use of Designated Strata Lot
- Mech denotes mechanic room
- Elev denotes elevator
- Vest denotes vestibule

Areas of Limited Common Property (Private Gardens and Balconies) lower/upper vertical extent are defined by the centre of the floor below/above or its extensions, or where there is no floor below/above, by the average height of a strata lot within the same building unless otherwise indicated.

Method of Measurement:

- Midpoint of structural portion of exterior walls
- Midpoint of structural portion of demising walls between strata lots

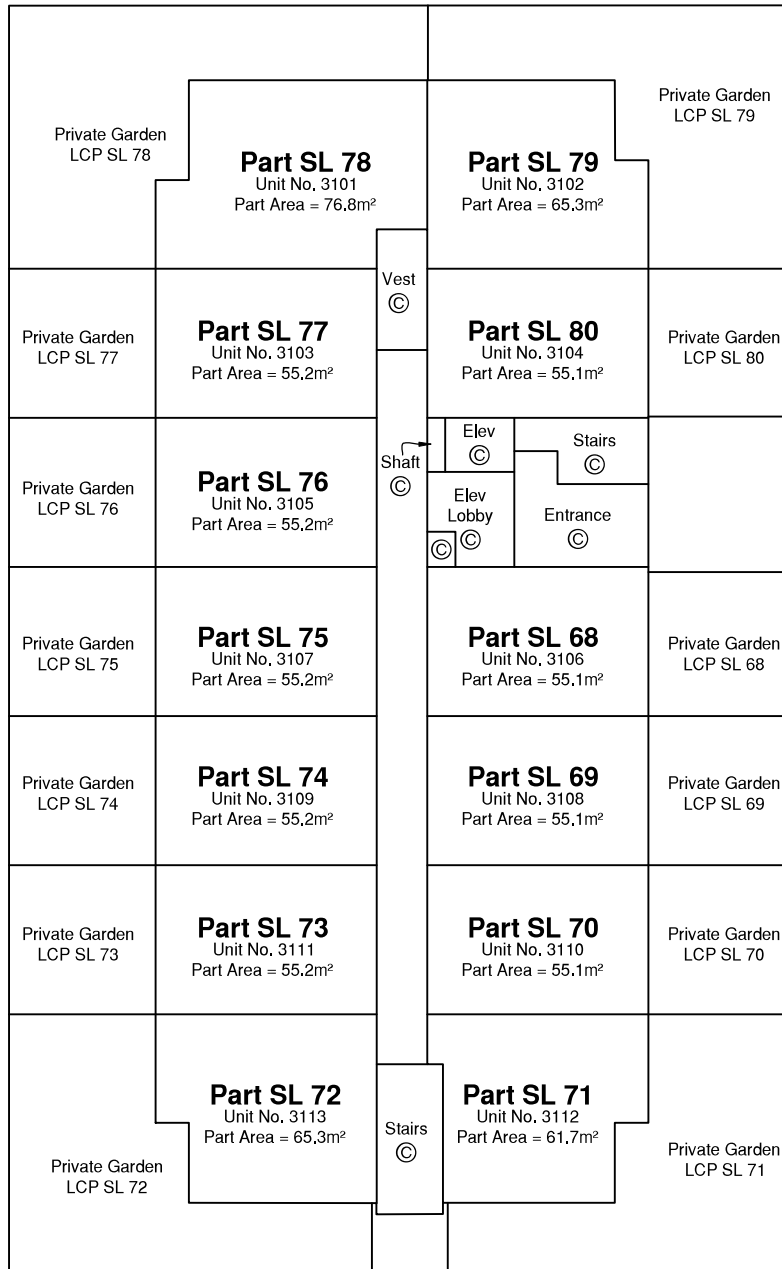

Plotted: 8/3/2023 10:40 AM User: Karla Herrera



202 - 1475 Ellis Street
Kelowna, BC

PROJECT REF./DRAWING No.
22-03760-001-DSC01-R2

BUILDING 3 - LEVEL 2 PART SL'S 68 TO 80 INCLUSIVE

PRE-STRATA PLAN PHASE 1



The intended plot size of this plan is 432mm in width by 280mm in height (B size) when plotted at a scale of 1:200.

LEGEND

- SL denotes Strata Lot
- ⊙ denotes Common Property
- LCP denotes Limited Common property for the Exclusive Use of Designated Strata Lot
- Mech denotes mechanic room
- Elev denotes elevator
- Vest denotes vestibule

Areas of Limited Common Property (Private Gardens and Balconies) lower/upper vertical extent are defined by the centre of the floor below/above or its extensions, or where there is no floor below/above, by the average height of a strata lot within the same building unless otherwise indicated.

Method of Measurement:

- Midpoint of structural portion of exterior walls
- Midpoint of structural portion of demising walls between strata lots

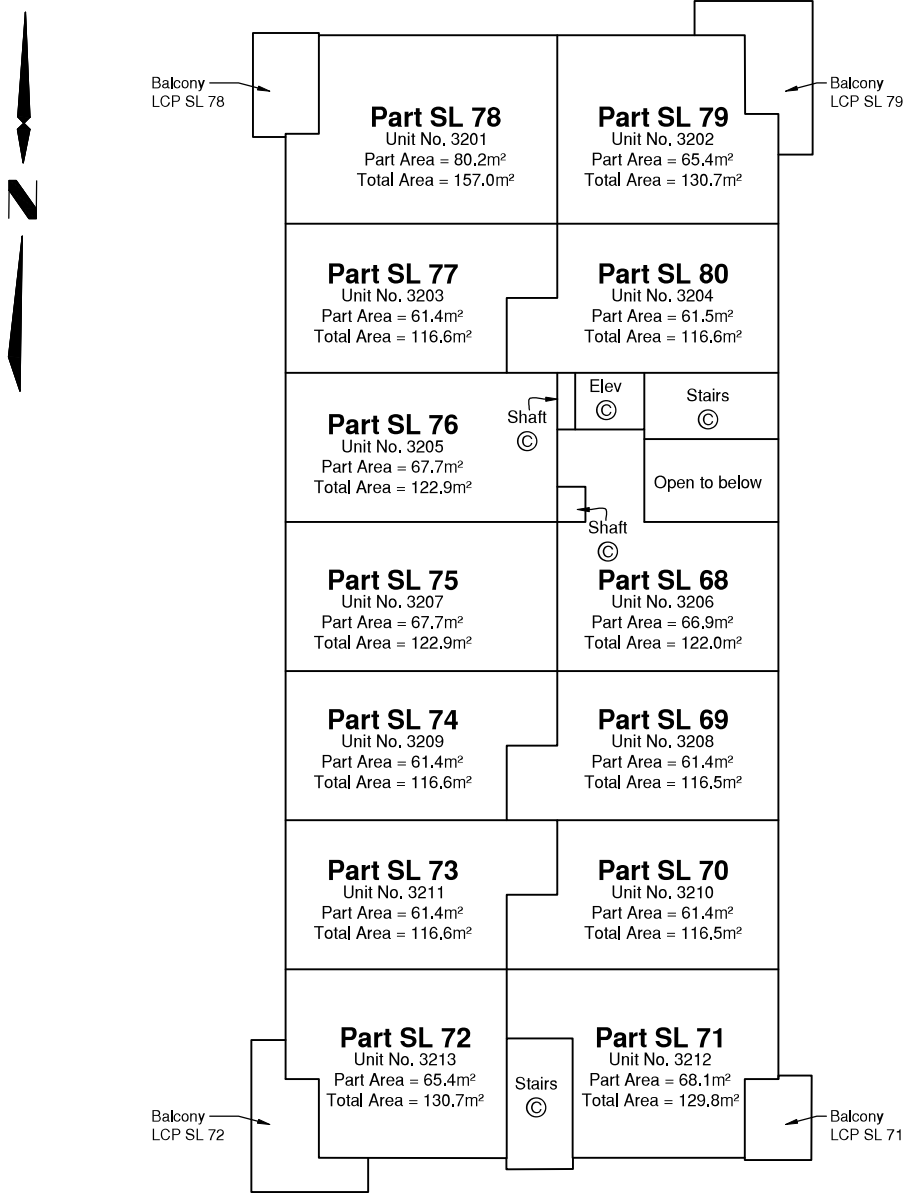

Plotted: 8/3/2023 10:40 AM User: Karla Herrera

GeoVerra
 202 - 1475 Ellis Street
 Kelowna, BC
 PROJECT REF./DRAWING No.
 22-03760-001-DSC01-R2

BUILDING 3 - LEVEL 3 SL'S 81 TO 88 INCLUSIVE

Sheet 16 of 19 Sheets

PRE-STRATA PLAN PHASE 1



The intended plot size of this plan is 432mm in width by 280mm in height (B size) when plotted at a scale of 1:200.

LEGEND

- SL denotes Strata Lot
- ⊙ denotes Common Property
- LCP denotes Limited Common property for the Exclusive Use of Designated Strata Lot
- Mech denotes mechanic room
- Elev denotes elevator
- Vest denotes vestibule

Areas of Limited Common Property (Private Gardens and Balconies) lower/upper vertical extent are defined by the centre of the floor below/above or its extensions, or where there is no floor below/above, by the average height of a strata lot within the same building unless otherwise indicated.

Method of Measurement:

- Midpoint of structural portion of exterior walls
- Midpoint of structural portion of demising walls between strata lots

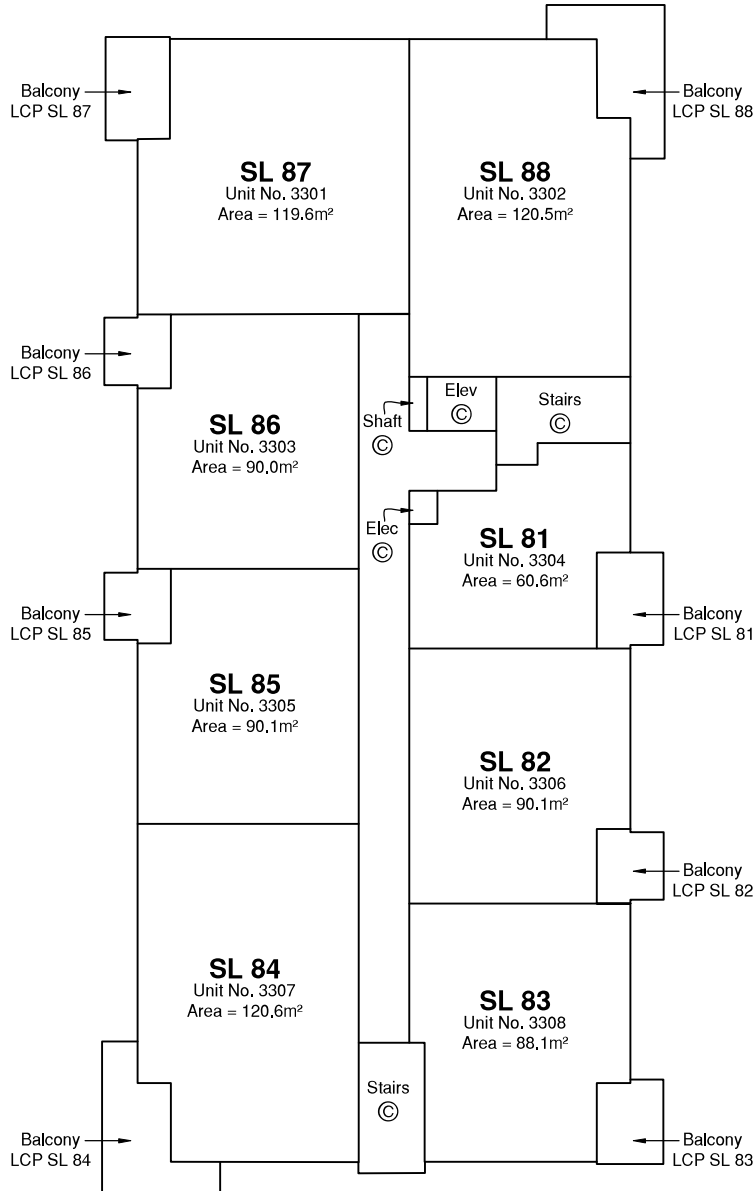

Plotted: 8/3/2023 10:40 AM User: Karla Herrera



202 - 1475 Ellis Street
Kelowna, BC

PROJECT REF./DRAWING No.
22-03760-001-DSC01-R2

Anna Niraz, BCLS 964
August 1st, 2023

BUILDING 3 - LEVEL 4 SL'S 89 TO 96 INCLUSIVE

Sheet 17 of 19 Sheets

PRE-STRATA PLAN PHASE 1



The intended plot size of this plan is 432mm in width by 280mm in height (B size) when plotted at a scale of 1:200.

LEGEND

- SL denotes Strata Lot
- ⊙ denotes Common Property
- LCP denotes Limited Common property for the Exclusive Use of Designated Strata Lot
- Mech denotes mechanic room
- Elev denotes elevator
- Vest denotes vestibule

Areas of Limited Common Property (Private Gardens and Balconies) lower/upper vertical extent are defined by the centre of the floor below/above or its extensions, or where there is no floor below/above, by the average height of a strata lot within the same building unless otherwise indicated.

Method of Measurement:

- Midpoint of structural portion of exterior walls
- Midpoint of structural portion of demising walls between strata lots

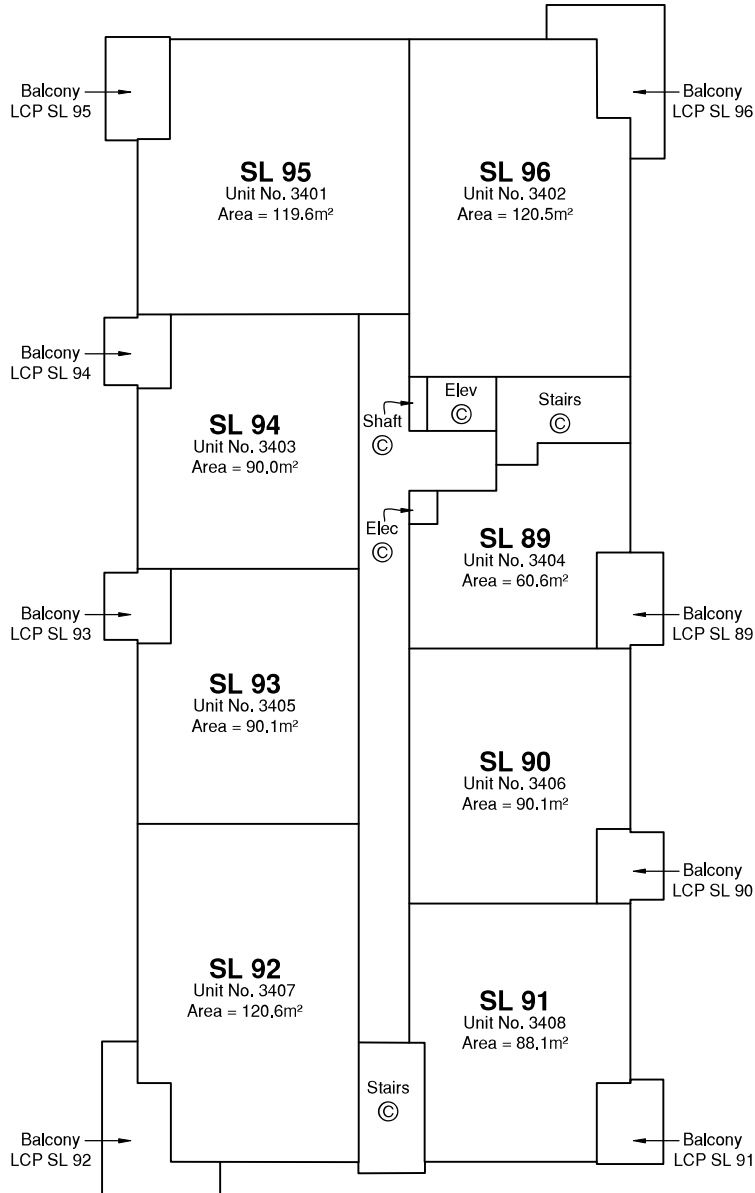

Plotted: 8/3/2023 10:40 AM User: Karla Herrera



202 - 1475 Ellis Street
Kelowna, BC

PROJECT REF./DRAWING No.
22-03760-001-DSC01-R2

Anna Niraz, BCLS 964
August 1st, 2023

BUILDING 3 - LEVEL 5 SL'S 97 TO 102 INCLUSIVE

Sheet 18 of 19 Sheets

PRE-STRATA PLAN PHASE 1



The intended plot size of this plan is 432mm in width by 280mm in height (B size) when plotted at a scale of 1:200.

LEGEND

- SL denotes Strata Lot
- ⊙ denotes Common Property
- LCP denotes Limited Common property for the Exclusive Use of Designated Strata Lot
- Mech denotes mechanic room
- Elev denotes elevator
- Vest denotes vestibule

Areas of Limited Common Property (Private Gardens and Balconies) lower/upper vertical extent are defined by the centre of the floor below/above or its extensions, or where there is no floor below/above, by the average height of a strata lot within the same building unless otherwise indicated.

Method of Measurement:

- Midpoint of structural portion of exterior walls
- Midpoint of structural portion of demising walls between strata lots

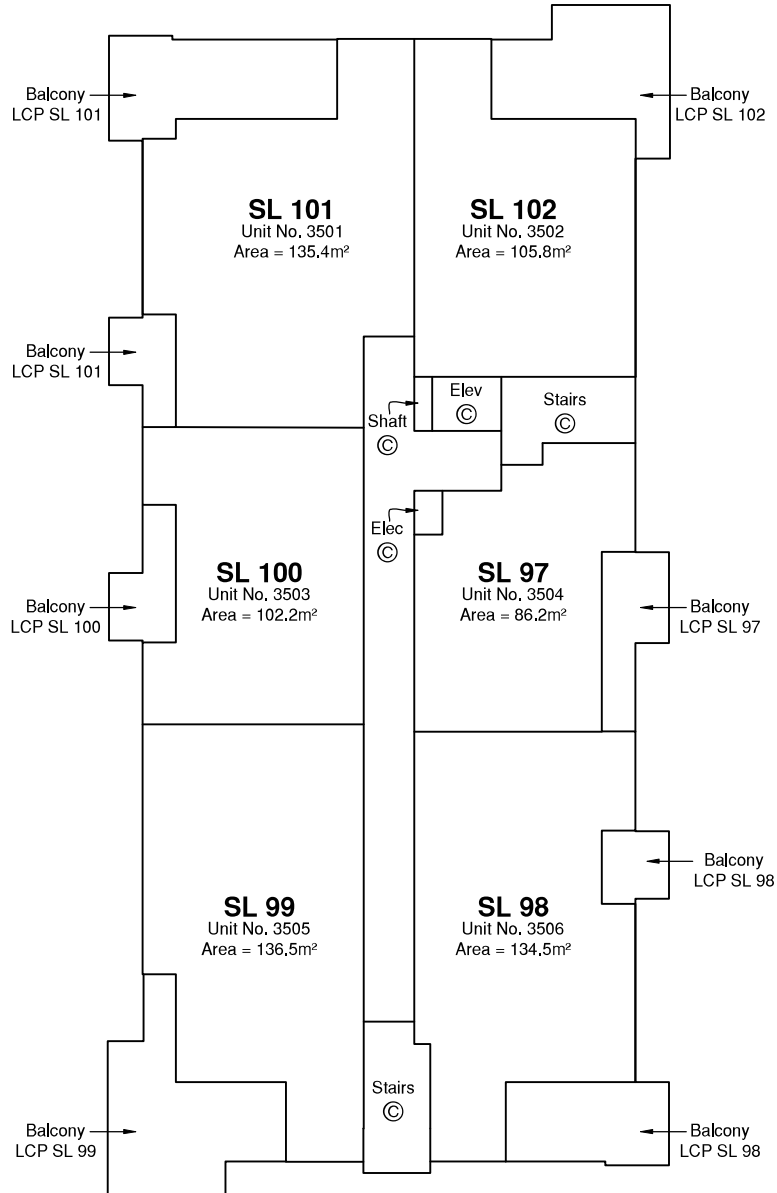

Plotted: 8/3/2023 10:40 AM User: Karla Herrera



202 - 1475 Ellis Street
Kelowna, BC

PROJECT REF./DRAWING No.
22-03760-001-DSC01-R2

BUILDING 3 - ROOF LEVEL

Sheet 19 of 19 Sheets

PRE-STRATA PLAN PHASE 1



The intended plot size of this plan is 432mm in width by 280mm in height (B size) when plotted at a scale of 1:200.

LEGEND

- SL denotes Strata Lot
- ⊙ denotes Common Property
- LCP denotes Limited Common property for the Exclusive Use of Designated Strata Lot
- Mech denotes mechanic room
- Elev denotes elevator
- Vest denotes vestibule

Areas of Limited Common Property (Private Gardens and Balconies) lower/upper vertical extent are defined by the centre of the floor below/above or its extensions, or where there is no floor below/above, by the average height of a strata lot within the same building unless otherwise indicated.

Method of Measurement:

- Midpoint of structural portion of exterior walls
- Midpoint of structural portion of demising walls between strata lots

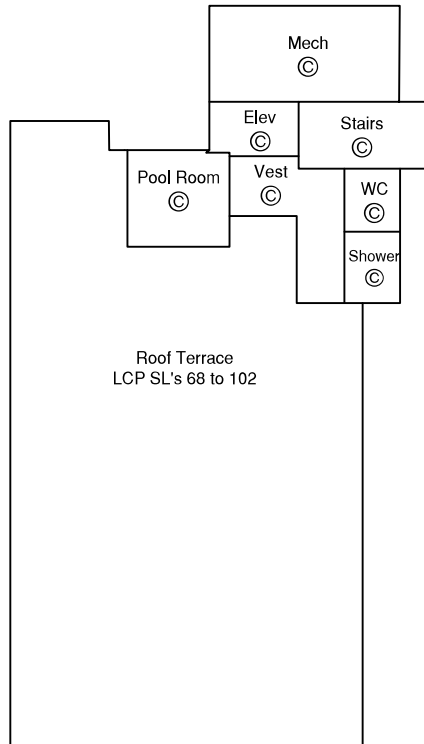

Plotted: 8/3/2023 10:40 AM User: Karla Herrera



202 - 1475 Ellis Street
Kelowna, BC

PROJECT REF./DRAWING No.
22-03760-001-DSC01-R2

Anna Niraz, BCLS 964
August 1st, 2023

EXHIBIT B
FORM P - PHASED STRATA PLAN DECLARATION
ORIGINAL FORM P

See attached.

FORM P

Strata Property Act

PHASED STRATA PLAN DECLARATION

(Section 221, 222)

We, 0929468 B.C. Ltd., of #900 - 900 West Hastings Street, Vancouver, B.C., Canada, declare:

1. That we intend to create a strata plan by way of phased development of the following land which we own:

<i>[parcel identifier]</i>	<i>[legal description]</i>
•	Lot • Section 23 Township 23 Range 2 West of the 6th Meridian Kootenay District Plan EPP•

2. That the plan of development is as follows:

- (a) The following is a schedule of the number of phases in the order in which the phases will be deposited in the Land Title Office and specifying any common facility to be constructed in conjunction with each particular phase:

Phase Number	Common Facilities
1	None
2	None

- (b) attached hereto as Schedule A is a sketch plan showing:
- (i) all the land to be included in the phased strata plan;
 - (ii) the proposed parcel boundaries;
 - (iii) the approximate boundaries of each phase; and
 - (iv) the approximate location of the common facilities.
- (c) the estimated date for the beginning of construction and completion of construction of each phase is as follows:

Phase Number	Estimated Date for Commencement of Construction	Estimated Date for Completion of Construction
1	August 1, 2023	September 1, 2025
2	August 1, 2024	September 1, 2026

- (d) the estimated unit entitlement of each phase and the estimated total unit entitlement of the completed development are as follows:

Phase Number	Unit Entitlement
1	10,946
2	10,946
Total:	21,892

- (e) the maximum number of units and the general type of residence or other structure to be built in each phase will be as follows:

Phase Number	No. of Units	No. of Buildings	Type of Structure
1	99	3	One (1) four-storey and two (2) five-storey buildings of load bearing steel stud and light weight steel truss construction constructed above a portion of a concrete underground parking facility.
2	99	3	One (1) four-storey and two (2) five-storey buildings of load bearing steel stud and light weight steel truss construction constructed above a portion of a concrete underground parking facility.
Total:	198	6	

3. We will elect to proceed with each phase on or by the following dates:

Phase Number	Date
1	August 1, 2024
2	August 1, 2025

[Signature page follows. Remainder of page left intentionally blank.]

0929468 B.C. LTD.

By: _____
Authorized Signatory

By: _____
Authorized Signatory

Date of Approval: _____ *

Signature of Approving Officer

City of Revelstoke

* Section 222(2) of the Act provides that approval expires after one year unless the first phase is deposited before that time.

SCHEDULE A
SKETCH PLAN

See attached.

SKETCH PLAN TO ACCOMPANY FORM P OF THE STRATA PROPERTY ACT FOR A PHASED STRATA DEVELOPMENT ON LOT B SECTION 23 TOWNSHIP 23 RANGE 2 WEST OF THE 6TH MERIDIAN KOOTENAY DISTRICT PLAN EPP125979 (Pending Registration)

BCGS 82L.100



The intended plot size of this plan is 432mm in width by 280mm in height (B size) when plotted at a scale of 1:1250.

LEGEND

- SL denotes Strata Lot
- © denotes Common Property
- · - denotes phase boundary

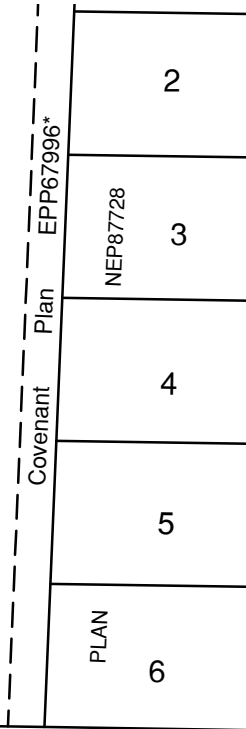
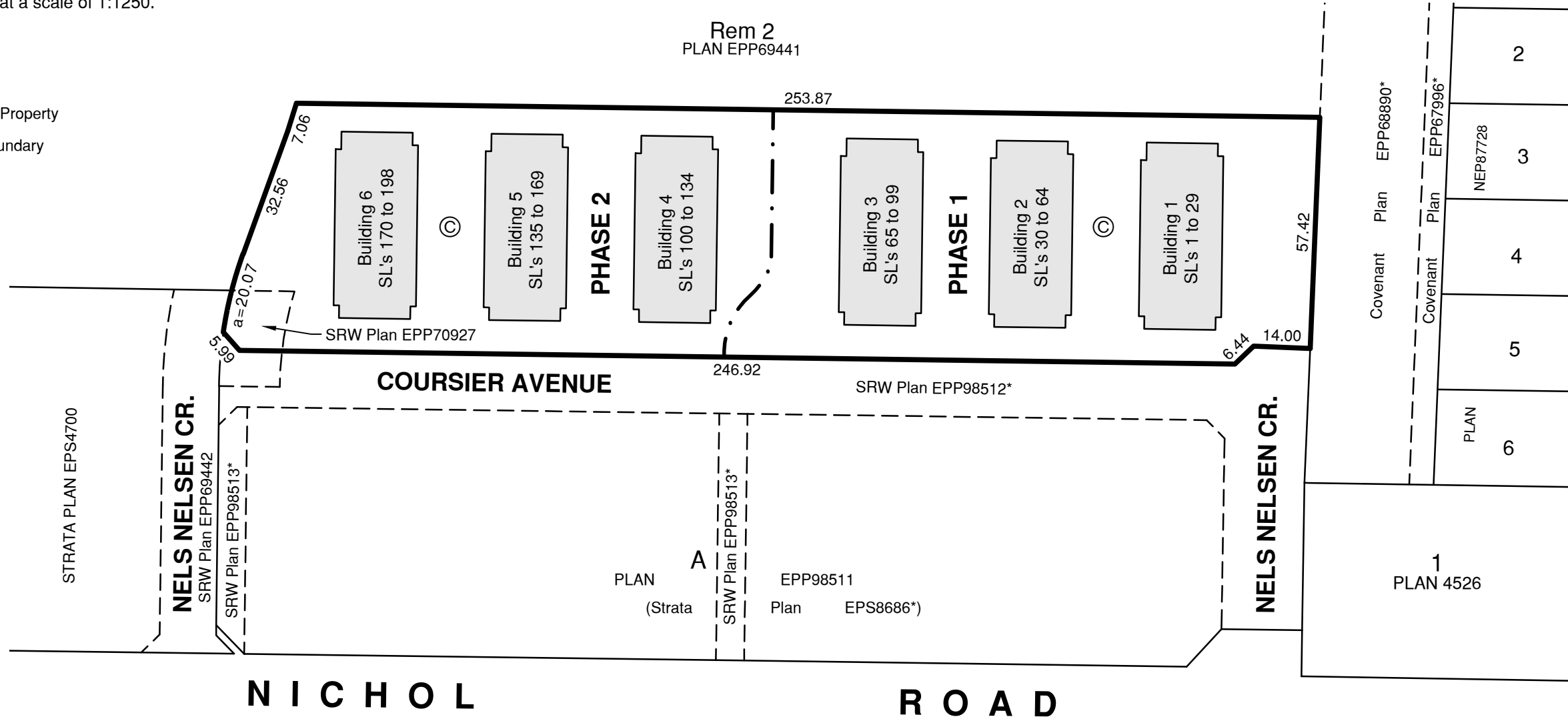

Plotted: 12/13/2022 12:30 PM User: Mike.Evans



202 - 1475 Ellis Street
Kelowna, BC

PROJECT REF./DRAWING No.
22-03760-001-FMP01

Project Name:
The Selkirks and Monashees at
MacKenzie Village

Civic Address:
Nichol Road, Revelstoke, BC

Phase 1 Strata Lots: 99
Phase 2 Strata Lots: 99
Total Strata Lots: 198

December 12, 2022

REVISED FORM P

See attached.

FORM P

Strata Property Act

PHASED STRATA PLAN DECLARATION

(Section 221, 222)

We, 0929468 B.C. Ltd., of #900 - 900 West Hastings Street, Vancouver, B.C., Canada, declare:

1. That we intend to create a strata plan by way of phased development of the following land which we own:

<i>[parcel identifier]</i>	<i>[legal description]</i>
•	Lot • Section 23 Township 23 Range 2 West of the 6th Meridian Kootenay District Plan EPP•

2. That the plan of development is as follows:

- (a) The following is a schedule of the number of phases in the order in which the phases will be deposited in the Land Title Office and specifying any common facility to be constructed in conjunction with each particular phase:

Phase Number	Common Facilities
1	None
2	None

- (b) attached hereto as Schedule A is a sketch plan showing:
- (i) all the land to be included in the phased strata plan;
 - (ii) the proposed parcel boundaries;
 - (iii) the approximate boundaries of each phase; and
 - (iv) the approximate location of the common facilities.
- (c) the estimated date for the beginning of construction and completion of construction of each phase is as follows:

Phase Number	Estimated Date for Commencement of Construction	Estimated Date for Completion of Construction
1	December 1, 2023	September 1, 2025
2	August 1, 2024	September 1, 2026

- (d) the estimated unit entitlement of each phase and the estimated total unit entitlement of the completed development are as follows:

Phase Number	Unit Entitlement
1	10,852
2	10,849
Total:	21,701

- (e) the maximum number of units and the general type of residence or other structure to be built in each phase will be as follows:

Phase Number	No. of Units	No. of Buildings	Type of Structure
1	102	3	One (1) four-storey and two (2) five-storey buildings of load bearing steel stud and light weight steel truss construction constructed above a portion of a concrete underground parking facility.
2	102	3	One (1) four-storey and two (2) five-storey buildings of load bearing steel stud and light weight steel truss construction constructed above a portion of a concrete underground parking facility.
Total:	204	6	

3. We will elect to proceed with each phase on or by the following dates:

Phase Number	Date
1	August 1, 2024
2	August 1, 2025

[Signature page follows. Remainder of page left intentionally blank.]

0929468 B.C. LTD.

By: _____
Authorized Signatory

By: _____
Authorized Signatory

Date of Approval: _____ *

Signature of Approving Officer

City of Revelstoke

* Section 222(2) of the Act provides that approval expires after one year unless the first phase is deposited before that time.

SCHEDULE A
SKETCH PLAN

See attached.

SKETCH PLAN TO ACCOMPANY FORM P OF THE STRATA PROPERTY ACT FOR A PHASED STRATA DEVELOPMENT ON LOT B SECTION 23 TOWNSHIP 23 RANGE 2 WEST OF THE 6TH MERIDIAN KOOTENAY DISTRICT PLAN EPP125979 (Pending Registration)

BCGS 82L.100



The intended plot size of this plan is 432mm in width by 280mm in height (B size) when plotted at a scale of 1:1250.

LEGEND

- SL denotes Strata Lot
- © denotes Common Property
- · - denotes phase boundary

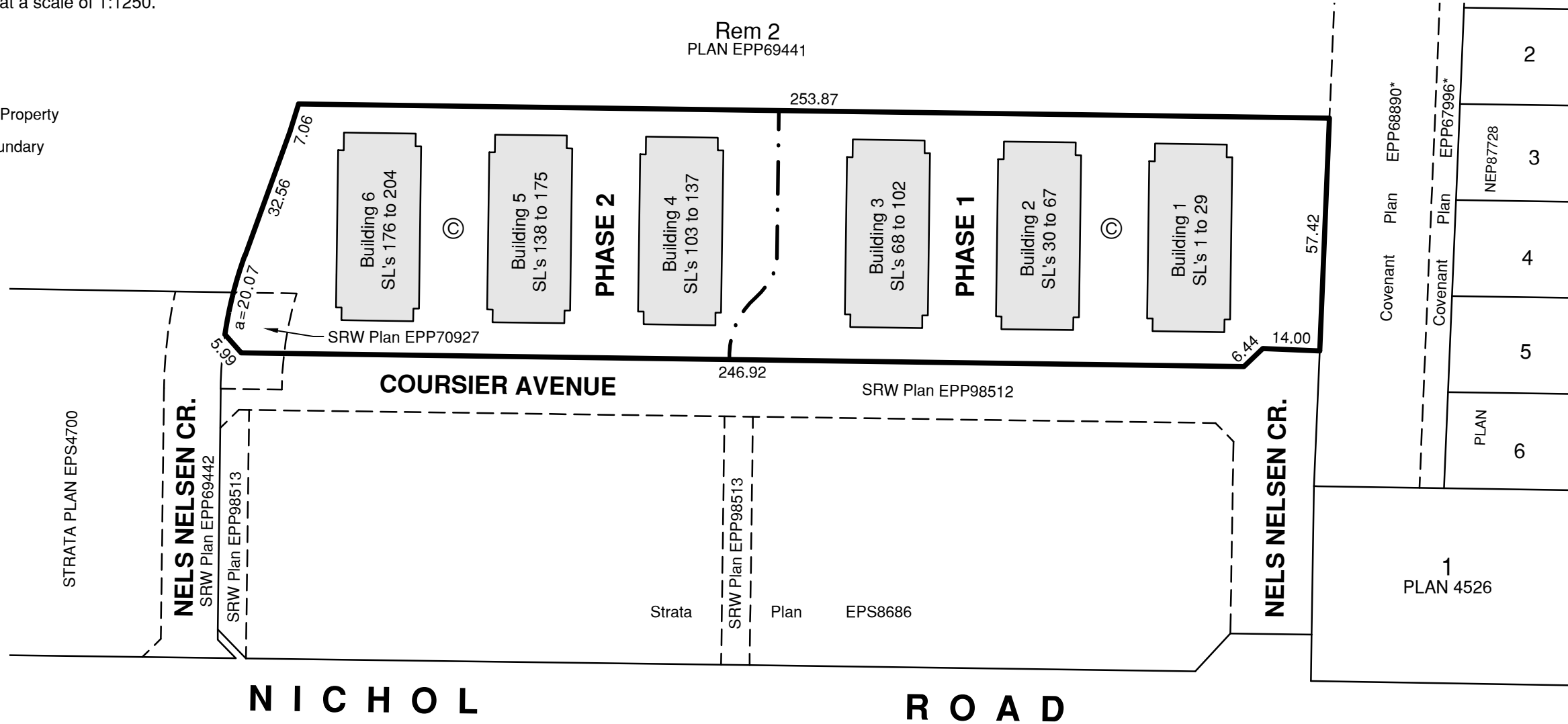

Project Name:
The Selkirks and Monashees at
MacKenzie Village

Civic Address:
Nichol Road, Revelstoke, BC

Phase 1 Strata Lots: 102
Phase 2 Strata Lots: 102
Total Strata Lots: 204

August 4th, 2023



202 - 1475 Ellis Street
Kelowna, BC

PROJECT REF./DRAWING No.
22-03760-001-FMP01-R2

EXHIBIT C-1

PROPOSED FORM V – SCHEDULE OF ESTIMATED UNIT ENTITLEMENT – PHASE 1

See attached.

Strata Property Act

FORM V

SCHEDULE OF UNIT ENTITLEMENT

(Sections 245(a), 246, 264)

Re: Strata Plan (unregistered), being a Phase 1 Pre-strata plan of

PID unavailable PART LOT B SECTION 23 TOWNSHIP 23 RANGE 2 WEST OF THE
6TH MERIDIAN KOOTENAY DISTRICT PLAN EPP125979
(Pending Registration)

STRATA PLAN CONSISTING ENTIRELY OF RESIDENTIAL STRATA LOTS

The unit entitlement for each residential strata lot is one of the following, as set out in the following table:

- (a) the habitable area of the strata lot, in square metres, rounded to the nearest whole number as determined by a British Columbia land surveyor as set out in section 246(3)(a)(i) of the *Strata Property Act*.

Certificate of British Columbia Land Surveyor

I, Anna Niraz, a British Columbia land surveyor, certify that the following table reflects the habitable area of each residential strata lot.

Date: August 2, 2023.



Signature

OR

- (b) a whole number that is the same for all of the residential strata lots as set out in section 246(3)(a)(ii) of the *Strata Property Act*.

OR

- (c) a number that is approved by the Superintendent of Real Estate in accordance with section 246(3)(a)(iii) of the *Strata Property Act*.

Signature of Superintendent of Real Estate

Strata Lot No.	Sheet No.	Habitable Area in m ²	Unit Entitlement	%* of Total Unit Entitlement**
1	3/4	122.0	122	1.1%
2	3/4	116.5	117	1.1%
3	3/4	116.5	117	1.1%
4	3/4	129.8	130	1.2%
5	3/4	130.7	131	1.2%
6	3/4	116.6	117	1.1%
7	3/4	116.6	117	1.1%
8	3/4	122.9	123	1.1%
9	3/4	122.9	123	1.1%
10	3/4	116.6	117	1.1%
11	3/4	157.0	157	1.4%
12	3/4	130.7	131	1.2%
13	3/4	116.6	117	1.1%
14	5	60.6	61	0.6%
15	5	90.1	90	0.8%
16	5	88.1	88	0.8%
17	5	120.6	121	1.1%
18	5	90.1	90	0.8%
19	5	90.0	90	0.8%
20	5	119.6	120	1.1%
21	5	120.5	121	1.1%
22	6	60.6	61	0.6%
23	6	90.1	90	0.8%
24	6	87.9	88	0.8%
25	6	120.8	121	1.1%
26	6	90.1	90	0.8%
27	6	90.0	90	0.8%
28	6	119.6	120	1.1%
29	6	120.7	121	1.1%

30	8	64.7	65	0.6%
31	8	65.8	66	0.6%
32	8	87.9	88	0.8%
33	8	121.2	121	1.1%
34	8	90.5	91	0.8%
35	8	90.6	91	0.8%
36	8	120.4	120	1.1%
37	8	121.3	121	1.1%
38	9	64.6	65	0.6%
39	9	65.7	66	0.6%
40	9	88.1	88	0.8%
41	9	120.7	121	1.1%
42	9	90.2	90	0.8%
43	9	90.3	90	0.8%
44	9	119.7	120	1.1%
45	9	120.8	121	1.1%
46	10	60.6	61	0.6%
47	10	90.1	90	0.8%
48	10	89.5	90	0.8%
49	10	120.6	121	1.1%
50	10	90.1	90	0.8%
51	10	90.1	90	0.8%
52	10	119.6	120	1.1%
53	10	120.5	121	1.1%
54	11	60.6	61	0.6%
55	11	90.1	90	0.8%
56	11	88.1	88	0.8%
57	11	120.6	121	1.1%
58	11	90.1	90	0.8%
59	11	90.0	90	0.8%

60	11	119.3	119	1.1%
61	11	120.5	121	1.1%
62	12	86.1	86	0.8%
63	12	134.5	135	1.2%
64	12	136.6	137	1.3%
65	12	102.2	102	0.9%
66	12	135.5	136	1.3%
67	12	105.8	106	1.0%
68	14/15	122.0	122	1.1%
69	14/15	116.5	117	1.1%
70	14/15	116.5	117	1.1%
71	14/15	129.8	130	1.2%
72	14/15	130.7	131	1.2%
73	14/15	116.6	117	1.1%
74	14/15	116.6	117	1.1%
75	14/15	122.9	123	1.1%
76	14/15	122.9	123	1.1%
77	14/15	116.6	117	1.1%
78	14/15	157.0	157	1.4%
79	14/15	130.7	131	1.2%
80	14/15	116.6	117	1.1%
81	16	60.6	61	0.6%
82	16	90.1	90	0.8%
83	16	88.1	88	0.8%
84	16	120.6	121	1.1%
85	16	90.1	90	0.8%
86	16	90.0	90	0.8%
87	16	119.6	120	1.1%
88	16	120.5	121	1.1%
89	17	60.6	61	0.6%

90	17	90.1	90	0.8%
91	17	88.1	88	0.8%
92	17	120.6	121	1.1%
93	17	90.1	90	0.8%
94	17	90.0	90	0.8%
95	17	119.6	120	1.1%
96	17	120.5	121	1.1%
97	18	86.2	86	0.8%
98	18	134.5	135	1.2%
99	18	136.5	137	1.3%
100	18	102.2	102	0.9%
101	18	135.4	135	1.2%
102	18	105.8	106	1.0%
Total number of lots: 102			Total unit entitlement: 10852	

* expression of percentage is for informational purposes only and has no legal effect
 ** not required for a phase of a phased strata plan

Date:

 Signature of Owner Developer

 Signature of Superintendent of Real Estate (if submitted under section 264 of the Act)

EXHIBIT D

PROPOSED FORM Y – NOTICE OF DIFFERENT BYLAWS

See attached.

Strata Property Act

FORM Y

OWNER DEVELOPERS' NOTICE OF DIFFERENT BYLAWS

(Section 245(d), Regulation section 14.6(2))

Re: Strata Plan EPS _____, being a strata plan of:
PID • Lot • Section 23 Township 23 Range 2 West Of The 6th Meridian
Kootenay District Plan EPP•

The following or attached bylaws differ from the Standard Bylaws to the Strata Property Act, as permitted by section 120 of the Act.

**See the bylaws attached as Schedule A which differ from the
Standard Bylaws to the Strata Property Act**

Date: _____, 202__.

0929468 B.C. LTD.

By: _____
Authorized Signatory

SCHEDULE A
BYLAWS
THE SELKIRKS AND MONASHEES AT MACKENZIE VILLAGE

The following bylaws replace the Standard Bylaws to the *Strata Property Act* (British Columbia) (the “**Act**”), as permitted pursuant to section 120 of the Act.

**PART 1 - DUTIES OF OWNERS OF ALL STRATA LOTS, TENANTS,
OCCUPANTS AND VISITORS**

1.1 Payment of strata fees

- (a) An owner must pay strata fees to the strata corporation on or before the first day of the month to which the strata fees relate.
- (b) If an owner is late in paying his or her strata fees, the owner must pay to the strata corporation interest on the late payment in the amount of 12% per annum compounded annually, and allocated on a monthly basis commencing the date the payment was due and continuing until the last day of the month in which it is paid. In addition to interest, failure to pay strata fees on the due date will result in a fine of \$50, for each month or portion thereof, which fine is payable to the strata corporation or, if directed by the strata council, to the professional property management company providing services to the strata corporation.
- (c) Any payments made by an owner will first be applied to the payment of outstanding interest, fines and special levies, and secondly to the payment of outstanding strata fees.

1.2 Repair and maintenance of property by owner

- (a) An owner must repair and maintain the owner’s strata lot, except for repair and maintenance that is the responsibility of the strata corporation under these bylaws.
- (b) An owner who has the use of limited common property must repair and maintain it, except for repair and maintenance that is the responsibility of the strata corporation under these bylaws.
- (c) Without limiting the generality of bylaw 1.2(b), each owner will be responsible for periodic and seasonal non-invasive cleaning and maintenance of all limited common property allocated to that owner’s strata lot, including any balconies, patios, terraces, decks and roof decks (including drains located thereon) and will be responsible for any and all damages, costs and expenses (including strata corporation insurance deductibles) that occur as a result of a failure to clean and maintain such limited common property. Additionally, each owner will be responsible for promptly notifying the property manager of any issues with their limited common property, such as, for example, pooling of water on balconies, patios, terraces and roof decks.

1.3 Use of property

- (a) An owner, tenant, occupant, employee, agent, invitee, guest or visitor must not use a strata lot or the common property or the common assets in a manner that:
 - (i) causes a nuisance, disturbance or hazard to another person;
 - (ii) causes unreasonable or repetitive noise;
 - (iii) unreasonably interferes with the rights of other persons to use and enjoy the common property, common assets or another strata lot;
 - (iv) is illegal; or
 - (v) is contrary to a purpose for which the strata lot or common property is intended as shown expressly or by necessary implication on or by the strata plan.
- (b) An owner, tenant, occupant, employee or visitor must not cause damage, other than reasonable wear and tear, to the common property, common assets or those parts of a strata lot which the strata corporation must repair and maintain under these bylaws or insure under section 149 of the Act.
- (c) An owner will not:
 - (i) use, or permit any occupant of his or her strata lot or a guest, employee, agent or invitee of the owner or occupant to use, a strata lot for any purposes other than residential purposes and other purposes ancillary to residential purposes. For the purposes of this subsection 1.3(c), “ancillary to residential purposes” includes, without limitation, vacation rental;
 - (ii) use, or permit any occupant of his or her strata lot or a guest, employee, agent or invitee of the owner or occupant to use, any musical instrument, amplifier, sound reproduction equipment or other device within or about any strata lot or, the common property or any limited common property such that it causes a disturbance or interferes with the comfort of any other owner or occupant;
 - (iii) obstruct or use, or permit any occupant of his or her strata lot or a guest, employee, agent or invitee of the owner or occupant to obstruct or use, the sidewalks, walkways, passages and driveways of the common property for any purpose other than ingress or egress from the strata lots or parking areas within the common property of the strata plan;
 - (iv) use, or permit any occupant of his or her strata lot or any guest, employee, agent or invitee of the owner or occupant to use, a barbecue, hibachi or other like cooking device on a patio, balcony, terrace, deck or roof deck unless such barbecue, hibachi or cooking device is powered by propane, natural gas or electricity and such propane, natural gas or electricity powered barbecues, hibachis and other light cooking devices

will not be used except in accordance with rules and regulations made by the strata corporation from time to time;

- (v) shake, or permit any occupant of his or her strata lot or any guest, employee, agent or invitee of the owner or occupant to shake, any mops or dusters of any kind, nor throw, or permit any occupant of his or her strata lot or any guest, employee, agent or invitee of the owner or occupant to throw, any refuse, including, without limitation, cigarettes or any like smoking items, out of the windows or doors or from the patio, balcony, terrace, deck or roof deck of a strata lot;
- (vi) do, or permit any occupant of his or her strata lot or any guest, employee, agent or invitee of the owner or occupant to do, anything that will increase the risk of fire or the rate of insurance on the building or any part thereof;
- (vii) leave, or permit any occupant of his or her strata lot or any guest, employee, agent or invitee of the owner or occupant to leave, on the common property or any limited common property, any shopping cart or any other item designated from time to time by the council;
- (viii) allow his or her strata lot to become unsanitary or a source of odour;
- (ix) install, or permit any occupant of his or her strata lot or any guest, employee, agent or invitee of the owner or occupant to install, any window coverings, visible from the exterior of his or her strata lot which are different in size or colour from those of the original building specifications;
- (x) hang or display, or permit any occupant of his or her strata lot or any guest, employee, agent or invitee of the owner or occupant to hang or display, any laundry, washing, clothing, bedding or other articles from windows, patios, balconies, terraces, decks, roof decks or other parts of the building so that they are visible from the outside of the building;
- (xi) use or install, or permit any occupant of his or her strata lot or any guest, employee, agent or invitee of the owner or occupant use or install, in or about the strata lot any shades, awnings, window or balcony guards or screens, ventilators, supplementary heating or air conditioning devices, except those installations approved in writing by the council or originally installed by the developer;
- (xii) erect on or fasten to, or permit any occupant of his or her strata lot or any guest, employee, agent or invitee of the owner or occupant to erect on or fasten to, the strata lot, the common property or any limited common property any television or radio antenna or similar structure or appurtenance thereto without the prior approval of the strata corporation;
- (xiii) place, or permit any occupant of his or her strata lot or any guest, employee, agent or invitee of the owner or occupant to place any signs, billboards, notices or other advertising matter of any kind on, or visible from, the exterior of a strata lot;

- (xiv) place, or permit any occupant of his or her strata lot or a guest, employee, agent or invitee of the owner or occupant to place any indoor-outdoor carpeting on any patio, balcony, terrace, deck or roof deck, or place any items on any patio, balcony, terrace, deck or roof deck except free-standing, self-contained planter boxes, summer furniture and accessories nor install, or permit any occupant of his or her strata lot or a guest, employee, agent or invitee of the owner or occupant to install, any hanging plants or baskets or other hanging items within three feet of a patio, balcony, terrace, deck or roof deck railing line;
- (xv) give, or permit any occupant of his or her strata lot to give, any keys, combinations, security cards or other means of access to the building, the parking garage or common areas to any person other than an employee, contractor, occupant or guest of the strata lot permitted by these bylaws; and
- (xvi) will not use, license or permit the strata lot to be used or occupied by any person for any type of short-term or hotel-type commercial accommodation, including but not limited to, as a hotel room, bed and breakfast, home stay, student housing, Airbnb or similar service, and will not advertise or promote the use or occupancy of the strata lot for such purposes, unless and until the owner obtains all necessary licences, including business licences, if any, from the City of Revelstoke and provides copies of same to the strata corporation.

1.4 Inform strata corporation

Within 2 weeks of becoming an owner, an owner must inform the strata corporation of the owner's name, strata lot number and mailing address outside the strata plan, if any.

1.5 Obtain approval before altering a strata lot

- (a) An owner, tenant or occupant must obtain the written approval of the strata corporation before making an alteration to a strata lot that involves any of the following:
 - (i) the structure of a building;
 - (ii) the exterior of a building;
 - (iii) stairs, patios, balconies, terraces, decks and roof decks (including drains located thereon) and other things attached to the exterior of the building;
 - (iv) doors, windows or skylights (including without limitation frames and sills) on the exterior of the building, or that front on the common property;
 - (v) fences, railings or similar structures that enclose patios, balconies, terraces, decks roof decks and yards;
 - (vi) common property located within the boundaries of a strata lot;

- (vii) parts of the strata lot which the strata corporation must insure under section 149 of the Act.
- (b) The strata corporation must not unreasonably withhold its approval under subsection (1), but may require as a condition of its approval that the owner agree, in writing, to take responsibility for any expenses relating to the alteration, including, without limitation, the cost of insurance and/or any increases in insurance premiums as a result of the alteration.
- (c) An owner must not do, or permit any occupant of his or her strata lot or any tenant, employee, agent, invitee, guest or visitor of the owner or occupant to do, any act, nor alter, or permit any occupant of his or her strata lot or any tenant, employee, agent, invitee, guest or visitor of the owner or occupant to alter, his or her strata lot, in any manner, which in the opinion of the council will alter the exterior appearance of the building.

1.6 **Obtain approval before altering common property**

- (a) An owner, tenant or occupant must obtain the written approval of the strata corporation before making an alteration to common property, including limited common property, or common assets.
- (b) The strata corporation may require as a condition of its approval that the owner agree, in writing, to take responsibility for any expenses relating to the alteration and to provide, at the request of the strata corporation, evidence of appropriate insurance coverage relating to the alteration.

1.7 **Permit entry to strata lot**

- (a) An owner, tenant, occupant or visitor must allow a person authorized by the strata corporation to enter the strata lot:
 - (i) in an emergency, without notice, to ensure safety and/or prevent significant loss and/or damage, and
 - (ii) at a reasonable time, on 48 hours' written notice,
 - (iii) to inspect, repair or maintain common property, common assets and any portions of a strata lot that are the responsibility of the strata corporation to repair and maintain under these bylaws or insure under section 149 of the Act, and
 - (iv) to ensure compliance with the Act and these bylaws.
- (b) The notice referred to in subsection (1)(b) must include the date and approximate time of entry, and the reason for entry.
- (c) In exercising its rights under this bylaw, the strata corporation will not unreasonably interfere with the operation of any occupant of a strata lot.

1.8 Compliance with bylaws

An owner, tenant, occupant, employee, agent, invitee, guest or visitor must comply strictly with these bylaws and with any rules adopted by the strata corporation from time to time.

1.9 Claims on Insurance Policies

An owner, tenant or occupant must not do, or omit to do, whether deliberately or accidentally, any act which would result in a claim being made on the insurance policy of the strata corporation.

1.10 Owner Insurance and Indemnity for Damage to Common Property and Strata Lots

- (a) It is recommended that each owner obtain and maintain liability and property insurance on his or her strata lots sufficient to cover the cost of any insurance deductibles or uninsured repair costs charged to the owner by the strata corporation pursuant to this bylaw.
- (b) An owner will indemnify and save harmless the strata corporation from the expense of any maintenance, repair or replacement rendered necessary to the common property, limited common property, common assets or to any strata lot arising from any incident occurring or originating in the owner's strata lot, whether such incident is caused or contributed to by the owner's act, omission, negligence or carelessness or by that of an owner's visitors, occupants, guests, employees, agents, tenants, but only to the extent that such expense is not reimbursed from the proceeds received by operation of any insurance policy. In such circumstances, any insurance deductible paid or payable by the strata corporation will be considered an expense not covered by the proceeds received by the strata corporation as insurance coverage and will be charged to the owner.

Without limiting the generality of the foregoing, an owner is strictly liable to the strata corporation and to other owners and occupants for any damage to common property, limited common property, and common assets or to any strata lot as a result of:

- (i) any of the following items located in the owner's strata lot:
 - A. dishwasher;
 - B. refrigerator;
 - C. washing machine;
 - D. dryer;
 - E. stove;
 - F. cook top
 - G. range;

- H. microwave;
 - I. heating/cooling system;
 - J. toilets, sinks, bathtubs and, where located wholly within the strata lot and accessible to the owner, plumbing pipes, fixtures and hoses;
 - K. anything introduced into the strata lot by the owner;
- (ii) any alterations or additions to the strata lot, the limited common property or the common property made by the owner or by a prior owner(s) of the strata lot;
 - (iii) damage arising from a blocked drain on the deck, balcony, patio, terrace, or roof deck designated as limited common property for the owner's strata lot;
 - (iv) any pets residing in or visiting at the owner's strata lot; and
 - (v) any children residing in or visiting at the owner's strata lot.

For the purposes of this bylaw 1.10, any insurance deductibles or uninsured repair costs charged to an owner will be added to and become part of the assessment of that owner for the month next following the date on which the expense was incurred and will become due and payable on the date of payment of the monthly assessment.

PART 2 - POWERS AND DUTIES OF STRATA CORPORATION AND COUNCIL

2.1 Repair and maintenance of property by strata corporation

The strata corporation must repair and maintain all of the following:

- (a) common assets of the strata corporation;
- (b) common property that has not been designated as limited common property;
- (c) limited common property, but the duty to repair and maintain it is restricted to:
 - (i) repair and maintenance that in the ordinary course of events occurs less often than once a year, and
 - (ii) the following, no matter how often the repair or maintenance ordinarily occurs:
 - (iii) the structure of a building;
 - (iv) the exterior of a building;
 - (v) stairs, patios, balconies, terraces, decks and roof decks (including drains located thereon) and other things attached to the exterior of the building;

- (vi) doors, windows or skylights (including without limitation frames and sills) on the exterior of the building or that front on the common property; and
 - (vii) fences, railings and similar structures that enclose patios, balconies, terraces, decks, roof decks and yards.
- (d) a strata lot in a strata plan that is not a bare land strata plan, but the duty to repair and maintain it is restricted to:
- (i) the structure of a building,
 - (ii) the exterior of a building,
 - (iii) stairs, patios, balconies, terraces, decks and roof decks (including drains located thereon) and other things attached to the exterior of the building;
 - (iv) doors, windows and skylights (including without limitation frames and sills) on the exterior of the building or that front on the common property; and
 - (v) fences, railings and similar structures that enclose patios, balconies, terraces, decks, roof decks and yards.

2.2 Council size

- (a) The council must have at least 3 and not more than 7 members.
- (b) If the strata plan has fewer than 4 strata lots or the strata corporation has fewer than 4 owners, all the owners are on the council.

2.3 Council members' terms

- (a) The term of office of a council member ends at the end of the annual general meeting at which the new council is elected.
- (b) A person whose term as council member is ending is eligible for reelection.

2.4 Removing council member

- (a) Unless all the owners are on the council, the strata corporation may, by a resolution passed by a majority vote at an annual or special general meeting, remove one or more council members.
- (b) After removing a council member, the strata corporation must hold an election at the same annual or special general meeting to replace the council member for the remainder of the term.
- (c) No person may stand for council or continue to be on council with respect to a strata lot if the strata corporation is entitled to register a lien against that strata lot under the Act and/or if their strata fees are in arrears.

2.5 Replacing council member

- (a) If a council member resigns or is unwilling or unable to act for a period of 2 or more months, the remaining members of the council may appoint a replacement council member for the remainder of the term.
- (b) A replacement council member may be appointed from any person eligible to sit on the council.
- (c) The council may appoint a council member under this section even if the absence of the member being replaced leaves the council without a quorum.
- (d) If all the members of the council resign or are unwilling or unable to act for a period of 2 or more months, persons holding at least 25% of the strata corporation's votes may hold a special general meeting to elect a new council by complying with the provisions of the Act, the regulations and the bylaws respecting the calling and holding of meetings.

2.6 Officers

- (a) At the first meeting of the council held after each annual general meeting of the strata corporation, the council must elect, from among its members, a president and a vice president, and may elect a secretary and a treasurer.
- (b) A person may hold more than one office at a time, other than the offices of president and vice president.
- (c) The vice president has the powers and duties of the president:
 - (i) while the president is absent or is unwilling or unable to act, or
 - (ii) for the remainder of the president's term if the president ceases to hold office.
- (d) If an officer other than the president is unwilling or unable to act for a period of 2 or more months, the council members may appoint a replacement officer from among themselves for the remainder of the term.

2.7 Calling council meetings

- (a) Any council member may call a council meeting by giving the other council members at least one week's notice of the meeting, specifying the reason for calling the meeting.
- (b) The notice does not have to be in writing.
- (c) A council meeting may be held on less than one week's notice if:
 - (i) all council members consent in advance of the meeting, or
 - (ii) the meeting is required to deal with an emergency situation, and all council members either:

- (iii) consent in advance of the meeting, or
 - (iv) are unavailable to provide consent after reasonable attempts to contact them.
- (d) The council must inform owners about the council meeting as soon as feasible after the meeting has been called.

2.8 Requisition of council hearing

- (a) By application in writing, stating the reason for the request, an owner or tenant may request a hearing at a council meeting.
- (b) If a hearing is requested under subsection (1), the council must hold a meeting to hear the applicant within one month of the request.
- (c) If the purpose of the hearing is to seek a decision of the council, the council must give the applicant a written decision within one week of the hearing.

2.9 Quorum of council

- (a) A quorum of the council is
 - (i) 1, if the council consists of one member,
 - (ii) 2, if the council consists of 2, 3 or 4 members,
 - (iii) 3, if the council consists of 5 or 6 members, and
 - (iv) 4, if the council consists of 7 members.
- (b) Council members must be present in person at the council meeting to be counted in establishing quorum.

2.10 Council meetings

- (a) At the option of the council, council meetings may be held by electronic means, so long as all council members and other participants can communicate with each other.
- (b) If a council meeting is held by electronic means, council members are deemed to be present in person.
- (c) Owners may not attend council meetings as observers unless council, in its sole discretion, agrees to permit members to attend.
- (d) Despite subsection (3), no observers may attend those portions of council meetings that deal with any of the following:
 - (i) bylaw contravention hearings;
 - (ii) rental restriction bylaw exemption hearings;

- (iii) any other matters if the presence of observers would, in the council's opinion, unreasonably interfere with an individual's privacy.

2.11 **Voting at council meetings**

- (a) At council meetings, decisions must be made by a majority of council members present in person at the meeting.
- (b) Unless there are only 2 strata lots in the strata plan, if there is a tie vote at a council meeting, the president may break the tie by casting a second, deciding vote.
- (c) The results of all votes at a council meeting must be recorded in the council meeting minutes.

2.12 **Council to inform owners of minutes**

The council must inform owners of the minutes of all council meetings within 2 weeks of the meeting, whether or not the minutes have been approved.

2.13 **Delegation of council's powers and duties**

- (a) Subject to subsections (2) to (4), the council may delegate some or all of its powers and duties to one or more council members or persons who are not members of the council, and may revoke the delegation.
- (b) The council may delegate its spending powers or duties, but only by a resolution that
 - (i) delegates the authority to make an expenditure of a specific amount for a specific purpose, or
 - (ii) delegates the general authority to make expenditures in accordance with subsection (3).
- (c) A delegation of a general authority to make expenditures must
 - (i) set a maximum amount that may be spent, and
 - (ii) indicate the purposes for which, or the conditions under which, the money may be spent.
- (d) The council may not delegate its powers to determine, based on the facts of a particular case,
 - (i) whether a person has contravened a bylaw or rule,
 - (ii) whether a person should be fined, and the amount of the fine, or
 - (iii) whether a person should be denied access to a recreational facility.

2.14 Spending restrictions

- (a) A person may not spend the strata corporation's money unless the person has been delegated the power to do so in accordance with these bylaws.
- (b) Despite subsection (1), a council member may spend the strata corporation's money to repair or replace common property or common assets if the repair or replacement is immediately required to ensure safety and/or prevent significant loss or damage.

2.15 Limitation on liability of council member

- (a) A council member who acts honestly and in good faith is not personally liable because of anything done or omitted in the exercise or intended exercise of any power or the performance or intended performance of any duty of the council.
- (b) Subsection (1) does not affect a council member's liability, as an owner, for a judgment against the strata corporation.

2.16 Consents

- (a) Any consent, approval or permission given under these bylaws by the council will be revocable at any time upon reasonable notice.
- (b) Notwithstanding any provision of the Act, the strata corporation may proceed under the *Small Claims Act* (British Columbia) against an owner or other person to collect money owing to the strata corporation, including money owing as a fine, without requiring authorization by a resolution passed by a 3/4 vote.

PART 3 - ENFORCEMENT OF BYLAWS AND RULES

3.1 Maximum fine

- (a) The strata corporation may fine an owner or tenant a maximum of
 - (i) \$200 for each contravention of a bylaw, and
 - (ii) \$50 for each contravention of a rule.
- (b) Additional assessments, fines authorized by these bylaws, banking charges, filing costs, legal expenses, interest charges and any other expenses incurred by the strata corporation to enforce these bylaws, as they may be amended from time to time, or any rule or regulation which may be established from time to time by the council pursuant to the Act or these bylaws, will become part of the assessment of the owner responsible and will become due and payable on the first day of the month next following, except that any amount owing in respect of a fine or the cost of remedying the contravention of a bylaw will be calculated as a separate component of such assessment and the strata corporation may not register a lien against or in respect of such separate component.

3.2 Continuing contravention

If an activity or lack of activity that constitutes a contravention of a bylaw or rule continues, without interruption, for longer than 7 days, a fine may be imposed every 7 days.

PART 4 - ANNUAL AND SPECIAL GENERAL MEETINGS

4.1 Person to chair meeting

- (a) Annual and special general meetings must be chaired by the president of the council.
- (b) If the president of the council is unwilling or unable to act, the meeting must be chaired by the vice president of the council.
- (c) If neither the president nor the vice president of the council chairs the meeting, a chair must be elected by the eligible voters present in person or by proxy from among those persons who are present at the meeting.

4.2 Participation by other than eligible voters

- (a) Tenants and occupants may attend annual and special general meetings, whether or not they are eligible to vote.
- (b) Persons who are not eligible to vote, including tenants and occupants, may participate in the discussion at the meeting, but only if permitted to do so by the chair of the meeting.
- (c) Persons who are not eligible to vote, including tenants and occupants, must leave the meeting if requested to do so by a resolution passed by a majority vote at the meeting.

4.3 Voting

- (a) At an annual or special general meeting, voting cards must be issued to eligible voters.
- (b) At an annual or special general meeting a vote is decided on a show of voting cards, unless an eligible voter requests a precise count.
- (c) If a precise count is requested, the chair must decide whether it will be by show of voting cards or by roll call, secret ballot or some other method.
- (d) The outcome of each vote, including the number of votes for and against the resolution if a precise count is requested, must be announced by the chair and recorded in the minutes of the meeting.
- (e) If there is a tie vote at an annual or special general meeting, the president, or, if the president is absent or unable or unwilling to vote, the vice president, may break the tie by casting a second, deciding vote.
- (f) If there are only 2 strata lots in the strata plan, subsection (5) does not apply.

- (g) Despite anything in this section, an election of council or any other vote must be held by secret ballot, if the secret ballot is requested by an eligible voter.
- (h) An owner who is otherwise an eligible voter may not exercise his or her vote for a strata lot, except on matters requiring a unanimous vote, if the strata corporation is entitled to register a lien against that strata lot.

4.4 **Order of business**

The order of business at annual and special general meetings is as follows:

- (a) certify proxies and corporate representatives and issue voting cards;
- (b) determine that there is a quorum;
- (c) elect a person to chair the meeting, if necessary;
- (d) present to the meeting proof of notice of meeting or waiver of notice;
- (e) approve the agenda;
- (f) approve minutes from the last annual or special general meeting;
- (g) deal with unfinished business;
- (h) receive reports of council activities and decisions since the previous annual general meeting, including reports of committees, if the meeting is an annual general meeting;
- (i) ratify any new rules made by the strata corporation;
- (j) report on insurance coverage, if the meeting is an annual general meeting;
- (k) approve the budget for the coming year, if the meeting is an annual general meeting;
- (l) deal with new business, including any matters about which notice has been given;
- (m) elect a council, if the meeting is an annual general meeting;
- (n) terminate the meeting.

4.5 **Electronic Attendance at Meetings**

- (a) Attendance by persons at an annual or special general meeting may be by telephone or other electronic method if such method permits all persons participating in the meeting to communicate with each other during the meeting.
- (b) If an annual or special general meeting is held by electronic means with a person, the person is deemed to be present in person for the purposes of the meeting.

PART 5 - COMMON EXPENSES

5.1 Strata fees

The strata lot owners' contributions to the common expenses of the strata corporation will be levied in accordance with this bylaw.

5.2 Expenses attributable to limited common property

Where the strata plan includes limited common property, expenses attributable to the limited common property which would not have been expended if the area had not been designated as limited common property will be borne by the owners of the strata lots entitled to use the limited common property in the proportion that the unit entitlement of each such strata lot bears to the aggregate unit entitlement of all strata lots entitled to use the limited common property.

PART 6 - PARKING

6.1 Parking and Storage

- (a) Each owner of a strata lot may be entitled to the exclusive use of zero, one or more than one of the parking stalls (the "**Parking Stalls**") and/or zero and/or one or more than one of the storage locker (the "**Storage Lockers**") located within the development's concrete underground parking facility (the "**Parking Facility**"), pursuant to a partial assignment of a parking and storage lease (the "**Parking and Storage Lease**") between the developer and Mackenzie Plaza Parking Co. Ltd., a copy of which is attached to the disclosure statement for the development. Pursuant to the Parking and Storage Lease, upon the registration of the strata plan for the development, the strata corporation will automatically assume all of the covenants and obligations of the developer, as landlord, under the Parking and Storage Lease with respect to those Parking Stalls and Storage Lockers within the development which are subject to the Parking and Storage Lease. Attached as Schedule B is a copy of the plan (the "**Parking and Storage Plan**") which shows the leased premises under the Parking and Storage Lease. For certainty, the Parking Stalls are those parking stalls denoted as **[NTD: Label to be confirmed based on final parking and storage plan.]** • on the Parking and Storage Plan and the Storage Lockers are those storage lockers located within the storage rooms shown outlined in bold on the Parking and Storage Plan.
- (b) An owner, tenant or occupant of a strata lot will not:
 - (i) use any Parking Stall except the Parking Stall (if any) which has been specifically assigned to the strata lot or, when specifically agreed with another strata lot owner, the Parking Stall assigned to the strata lot of that other owner;
 - (ii) use any Storage Locker in the development except the Storage Locker (if any), which has been specifically assigned to the strata lot or, when specifically agreed with another strata lot owner, the Storage Locker assigned to the strata lot of that other owner;

- (iii) rent or lease the Parking Stall or Storage Locker assigned to the strata lot or otherwise permit that Parking Stall or Storage Locker to be regularly used by anyone that is not an owner, tenant or occupant of a strata lot, the strata corporation or the tenant under the Parking and Storage Lease;
- (iv) use any Storage Locker within the development for any purpose other than keeping and storing personal property therein and not use any Storage Locker for any purpose which (i) creates a nuisance, disturbance, danger or hazard to any other person, (ii) may increase the risk of fire or the rate of insurance on the building or any part thereof, (iii) is unsanitary or a source of odour, (iv) is illegal, (v) involves keeping flammable, explosive or otherwise dangerous or hazardous materials therein, (vi) involves keeping animals or plants therein, (vii) causes damage to the development or any other person's property or (viii) unreasonably interferes with the rights of other persons to use and enjoy the common property or the strata lots in the development. If the strata corporation, acting reasonably, has any reason to believe that any Storage Locker is being used in a manner which is not permitted hereunder, then the strata corporation may, in an emergency, without notice, to ensure safety and/or prevent significant loss and/or damage, and otherwise at any reasonable time and upon on 24 hours' written notice, access such Storage Locker in order to inspect such Storage Locker and the contents thereof and remove and dispose of any such contents which are not permitted hereunder, at the cost and expense of the owner of the Storage Locker and/or the person using such Storage Locker, and the person entitled to the use of such Storage Locker will fully co-operate with the strata corporation in connection with the foregoing;
- (v) carry out, or permit any guest, employee, agent or invitee of the owner or occupant to carry out, any oil changes, major repairs or adjustments to motor vehicles or other mechanical equipment on common property or on any limited common property, including the Parking Facility, except in the case of emergency. An owner, tenant or occupant of a strata lot must promptly and at its own expense clean up any oil or other substance which spills or leaks onto the common property or limited common property, howsoever and whensoever such spill or leak occurs, from his or her vehicle, whether as a result of any activity prohibited by these bylaws or otherwise;
- (vi) store any boat, boat trailer or recreational vehicle on the common property or permit any guest to do so;
- (vii) park or store any vehicle which is inoperable or which cannot be moved under its own power anywhere on the common property, without the prior written approval from the executive of the strata corporation;
- (viii) park or store any vehicle within the Parking Facility, the common property or the limited common property, unless such owner, tenant or occupant has obtained adequate insurance in respect thereof;

- (ix) keep any bicycles on patios, balconies or decks. All bicycles must be stored in the Parking Stall, Storage Locker and/or bicycle rack assigned to the strata lot and must enter or exit the building only by way of vehicle entry to the Parking Facility;
- (x) store, or permit any guest to store, any personal property, other than bicycles, within the Parking Stall assigned to the strata lot or otherwise use the Parking Stall assigned to the strata lot other than for the parking of vehicles and bicycles therein (provided that the owner, tenant or occupant of a strata lot may store personal property in any storage box installed by the developer within the Parking Stall, if any, assigned to such strata lot); or
- (xi) rent or lease the Parking Stall(s) and/or the Storage Locker(s) which have been specifically assigned to the strata lot to any person other than an owner, purchaser, occupant or tenant of a strata lot, the strata corporation, the developer or Mackenzie Plaza Parking Co. Ltd.

6.2 Parking - Disabled Stall

Certain Parking Stalls (the “**Disabled Stalls**”) are designed and constructed to accommodate vehicles driven by disabled persons. Some or all of the Disabled Stalls will be allocated to the owners of strata lots by way of partial assignment of the Parking and Storage Lease, and may be allocated to, and used by, owners of strata lots who do not qualify for the use of disabled Parking Stalls. The strata corporation and every owner of a strata lot will be required to comply with the terms and provisions of the Parking and Storage Lease in connection with any request for an exchange of a Disabled Stall provided such request satisfies the requirements set out in the applicable section of the Parking and Storage Lease that deals with compulsory exchanges of Disabled Stalls.

6.3 Electric Charging at Parking Stalls

- (a) Certain Parking Stalls (the “**EV-Stalls**”) will be configured with an operational electric outlet and an electric service connection conduit with pull string to enable future activation of an electric vehicle plug-in charger (an “**EV Plug-in Charger**”) for electric vehicle charging. Some or all of the EV-Stalls will be allocated to the owners of strata lots by way of partial assignment of the Parking and Storage Lease. The strata corporation and every owner of a strata lot will be required to comply with the terms and provisions of the Parking and Storage Lease in connection with any request for an exchange of an EV-Stall provided such request satisfies the requirements set out in the applicable section of the Parking and Storage Lease that deals with compulsory exchanges of EV-Stalls.
- (b) If an owner or occupant of a strata lot with the right to use a given EV-Stall is using the EV-Stall for charging an electric vehicle (as determined by the Strata Corporation), then the owner will be required to pay a monthly user fee to the strata corporation (on account of electrical consumption) of \$30.00 per month or such other reasonable amount as determined by the strata council from time to time. For greater certainty, if an owner or occupant of a strata lot has the right to use more than one EV-Stall, then the foregoing user fee will be payable by the owner for each such EV-Stall that the owner or occupant is using for charging an

electric vehicle. The foregoing user fee is payable in addition to the monthly strata fee payable to the strata corporation.

- (c) An owner, tenant or occupant of a strata lot will have the exclusive right to use an EV Plug-in Charger or an electrical outlet, if any, which is appurtenant to an EV-Stall which has been assigned to such owner under the Parking and Storage Lease. An owner, tenant or occupant of a strata lot will not, and will not permit any visitor or invitee of the owner, tenant or occupant to, use any EV Plug-in Charger or electrical outlet in the Parking Facility except for an EV Plug-in Charger or electrical outlet, if any, which is appurtenant to an EV-Stall which has been assigned to such owner under the Parking and Storage Lease.

6.4 Removal of Vehicles

Any owner, tenant or occupant vehicle parked in violation of this PART 6 will be subject to removal by a towing company authorized by council, and all costs associated with such removal will be charged to the owner of the strata lot.

PART 7 - VOLUNTARY DISPUTE RESOLUTION

7.1 Voluntary dispute resolution

- (a) A dispute among owners, tenants, the strata corporation or any combination of them may be referred to a dispute resolution committee by a party to the dispute if:
 - (i) all the parties to the dispute consent, and
 - (ii) the dispute involves the Act, the regulations, the bylaws or the rules.
- (b) A dispute resolution committee consists of
 - (i) one owner or tenant of the strata corporation nominated by each of the disputing parties and one owner or tenant chosen to chair the committee by the persons nominated by the disputing parties, or
 - (ii) any number of persons consented to, or chosen by a method that is consented to, by all the disputing parties.
- (c) The dispute resolution committee must attempt to help the disputing parties to voluntarily end the dispute.

PART 8 - MARKETING ACTIVITIES BY DEVELOPER

8.1 Marketing activities

- (a) Notwithstanding anything to the contrary contained in these bylaws, during the time the developer is the owner or lessee of any strata lot, it and its marketing agents will have the right to:
 - (i) maintain any strata lot or strata lots, whether owned or leased by it, as display suites and/or presentation centres and to carry on any marketing,

leasing and sales functions within such strata lots and within any area of the common property and/or limited common property of the development including, without limitation, conducting tours of the development and holding marketing, leasing and sales events and other activities;

- (ii) erect and maintain signage on such strata lots owned by it and on the common property and/or limited common property of the development;
- (iii) have access to and permit public access to any and all parts of the common property, limited common property and common facilities for the purpose of showing strata lots, the common property, the limited common property and the common facilities to prospective purchasers and tenants and their representatives; and
- (iv) have the use of such available parking stalls within the development as are required in connection with its marketing, leasing and sales activities,

in each case as may be reasonably determined by the developer. The developer will act reasonably in exercising its rights under this section 8.1.

PART 9 - MISCELLANEOUS

9.1 Garbage and recycling disposal

An owner, tenant or occupant will remove ordinary household refuse, garbage and recycling from his or her strata lot and deposit it in the containers provided by the strata corporation for that purpose; all garbage will be bagged and tied before so depositing and the owner, tenant or occupant will remove any materials other than ordinary household refuse, garbage and recycling from the strata plan property at his or her expense.

9.2 Move in / move out

- (a) The strata corporation may regulate the times and manner in which any moves into or out of strata lots may be made, and, without limiting the generality of the foregoing, will require that a move-in fee of \$200 (or such other amount as the strata council may determine from time to time, provided that any such fee is charged on a consistent basis) be paid to the strata corporation in connection with any move in of a strata lot (other than the first move in to any given strata lot by the initial occupant thereof, for which no fee will be payable) on account of the added wear to common property that results from such move-in activities. Such fee will be payable:
 - (i) by the purchaser of the strata lot, where a new owner is moving in to the strata lot; or
 - (ii) by the owner of the strata lot, where a new tenant is moving in to the strata lot.

The strata corporation will require that all move ins and move outs be co-ordinated with the manager of the building at least 7 days in advance of such moves, or such lesser period as the council may, in its sole discretion, permit,

provided that if an owner carries out, or permits any tenant or occupant, or any guest, employee, agent or invitee of the owner or his or her tenant or an occupant of the strata lot, to carry out, any move into or out of his or her strata lot otherwise than in accordance with such prior arrangements made with the manager of the building, the owner will be subject to a fine of \$100 (in addition to any applicable move-in fee), such fine to be paid on or before the due date of the next monthly assessment payable by such owner.

- (b) An owner of a strata lot must notify the strata corporation in advance of the date and time that the owner or an occupant of his or her strata lot will be moving into or out of the strata lot.
- (c) An owner must ensure that the lobby doors are not left open, ajar or unattended and that furniture, boxes and/or other articles are not left piled in the lobby area.
- (d) An owner must ensure that all common areas are left damage free, clean and all hallways and lobby areas vacuumed immediately upon completion of the move.

9.3 Children and Supervision

- (a) Owners are responsible:
 - (i) for the conduct of visitors including ensuring that noise is kept at a level, in the sole determination of a majority of the council, that will not disturb the rights of quiet enjoyment of others;
 - (ii) for the conduct of children residing in their strata lot, including ensuring that noise is kept at a level, in the sole determination of a majority of the council, that will not disturb the quiet enjoyment of others; and
 - (iii) to assume liability for and properly supervise activities of children residing in or visiting their strata lot.

9.4 Rentals

- (a) Before a tenant may move into any strata lot, the owner will deliver or cause to be delivered to the strata corporation a "Form K - Notice of Tenant's Responsibilities" in the form set out in the Act, signed by the tenant.
- (b) An owner will advise the council in writing of the time and date that any tenant intends to move in or out of the strata lot, at least 7 days in advance and will make arrangements with the manager of the building to co-ordinate any such move in accordance with section 9.2.

9.5 Selling of strata lots

Subject to section 8.1, an owner of a strata lot, when selling his or her strata lot, will not permit "For Sale" signs to be placed on or about the common property except in a location to be determined by the council.

9.6 **Pets**

- (a) An owner, tenant or occupant must not keep any pets in a strata lot other than one or more of the following without the prior written approval of the strata corporation:
 - (i) a reasonable number of fish or other small aquarium animals;
 - (ii) up to 2 small caged mammals;
 - (iii) up to 4 caged birds;
 - (iv) dogs or cats, provided that the total number of dogs and cats does not exceed 2.
- (b) An owner, tenant, occupant, employee, agent, invitee, guest or visitor must ensure that all animals are leashed or otherwise secured when on the common property or on land that is a common asset.
- (c) No owner or occupant of a strata lot will permit his or her pet to urinate or defecate on the common property or on any limited common property, and if any pet does urinate or defecate on the common property or on any limited common property, the owner or occupant will immediately and completely remove all of his or her pet's waste from the common property or limited common property, as the case may be, and dispose of it in a waste container or by some other sanitary means and if, in the reasonable opinion of the strata corporation, any special cleaning is required as a result of the pet urinating or defecating, the owner or occupant will pay all costs of such special cleaning.
- (d) An owner whose tenant, employee, agent, invitee, guest or visitor brings an animal or pet onto the common property or any limited common property will be responsible to ensure that the tenant, employee, agent, invitee, guest or visitor complies with all requirements of these bylaws as they relate to pets and will perform all of the duties and obligations with respect to that animal as set out in these bylaws as if the animal were one kept by the owner or occupant in his or her strata lot.

9.7 **Planters**

An owner of a strata lot who has the benefit of limited common property which includes a planter containing trees, shrubs and/or other landscaping must water and maintain the trees, shrubs and/or other landscaping installed by the developer in such planter and such owner may not alter or remove the trees, shrubs and/or other landscaping installed by the developer without the prior written approval of the strata corporation.

9.8 **Access by Consultants**

The owners will permit the developer's building consultants and the consultants or representatives of any warranty provider in connection with the construction of the development, to have access to the development from time to time both during and after such construction

thereof and after completion of construction, for the purpose of inspecting and monitoring the building envelope and other components of the buildings comprising the development.

9.9 **Quorum for Annual or Special General Meeting**

- (a) If within 15 minutes from the time appointed for an annual or special general meeting a quorum is not present, the eligible voters present in person or by proxy constitute a quorum.
- (b) Notwithstanding section 48(3) of the Act, the failure to obtain a quorum for a meeting demanded under section 43 of the Act terminates, and does not adjourn, that meeting.

9.10 **Smoking Prohibition**

- (a) Smoking is prohibited everywhere on and within the development, including:
 - (i) in a strata lot;
 - (ii) on the exterior common property;
 - (iii) on the interior common property, including but not limited to in hallways, parking garages, electrical and mechanical rooms;
 - (iv) on patios and balconies;
 - (v) within 7.5 metres of a door, window or air intake; and
 - (vi) on any land that is a common asset.
- (b) For the purposes of this section, “smoking” includes, without limitation, emitting, causing or permitting any smoke or fume (tobacco, cannabis or otherwise) to emanate from a cigarette, electronic cigarette, vaporizer, hookah, pipe, bong, cigar or similar device or paraphernalia.
- (c) All persons, including, but not limited to, owners, tenants, occupants and visitors of strata lots must comply with this bylaw.

9.11 **Noise Control**

An owner, tenant or occupant must not use, or permit any occupant of his or her strata lot or any visitor or invitee of the owner or occupant to use, a strata lot, limited common property or common property in a way or for any purpose that causes unreasonable or undue noise and will take all reasonable steps to satisfy noise complaints from neighbours. Without limiting the generality of this bylaw an owner, tenant, or occupant will avoid, and will cause any occupant of his or her strata lot or any visitor or invitee of the owner or occupant to avoid, any activity that involves undue traffic or noise and the use or operation of noisy equipment (including, without limitation, stereos and speakers) or machinery in or around the strata lot between the hours of 10:00 p.m. and 7:00 a.m. or any activity that encourages loitering by persons in or about the strata lot or the common property.

9.12 Rooftop Amenity Areas

The amenity area on the rooftop of each building (each, a “**Rooftop LCP Amenity Area**”) is designated on the strata plan as limited common property for the strata lots in that particular building and, accordingly, the owners and occupants (and their visitors) of the strata lots in each particular building will, collectively, have exclusive use of the Rooftop LCP Amenity Area in such building. For greater certainty, an owner or occupant of a strata lot will not have the right to access or use any Rooftop LCP Amenity Area other than the Rooftop LCP Amenity Area located in the particular building in which such owner or occupant’s strata lot is located.

SCHEDULE B
PARKING AND STORAGE PLAN

See attached.

[NTD: Plan to be attached prior to the Bylaws being filed in the Land Title Office.]

EXHIBIT E-1

PROPOSED INTERIM BUDGET OF OPERATING EXPENSES – PHASE 1

See attached.

**Mackenzie Village Selkirks and Monashees Phase 1
PROPOSED OPERATING BUDGET**

ACCOUNT TITLE	PROPOSED
<u>REVENUE</u>	
Maintenance Fee Revenue	\$ 499,373.60
Interest Income	0.00
TOTAL REVENUE	\$ 499,373.60
<u>EXPENSES</u>	
Administration	
Audit Fees	\$ 375.00
Insurance	98,000.00
Insurance Appraisal	700.00
Telephone & Internet	2,250.00
Professional Fees	2,250.00
Management Fees	28,950.00
Photocopy / Postage / Courier	1,500.00
Miscellaneous	1,250.00
Total Administration	135,275.00
Building	
Carpet Cleaning	1,500.00
Window Cleaning	3,750.00
Fire Alarm Monitoring	1,000.00
Fire Equipment Maintenance	2,500.00
Gutter Cleaning	3,500.00
Pest Control	1,250.00
Elevator	28,500.00
Dryer Vent Cleaning	3,250.00
Janitorial/Caretaker Services	48,900.00
Supplies	1,500.00
Emergency Generator	2,500.00
Security	3,500.00
R&M Interior	7,500.00
R&M - General	19,251.00
Total Building	128,401.00
Utilities	
Electricity	42,000.00
Garbage Disposal	22,500.00
Water & Sewage	48,500.00
Total Utilities	113,000.00

Grounds Maintenance	
Landscaping	42,000.00
Irrigation	1,250.00
Snow Removal	16,250.00
Tree Maintenance	2,500.00
Contribution to MV Community Association for Road and Trail System and Bus Service	11,800.00
Total Grounds Maintenance	<u>73,800.00</u>
Recreation Area	
Amenity Maintenance	3,500.00
Spa Chemicals and Maintenance	1,850.00
Total Recreation Area	<u>3,500.00</u>
TOTAL EXPENSES	\$ 453,976.00
Transfer to CRF	\$ 45,397.60
TOTAL EXPENSES & TRANSFERS	\$ <u>499,373.60</u>
CURRENT YR OP SURPLUS (DEFICIT)	\$ <u>0.00</u>
OPENING BALANCE OP SURPLUS (DEFICIT)	\$
ENDING BALANCE OP SURPLUS (DEFICIT)	\$ <u><u>0.00</u></u>

EXHIBIT F

**CUMULATIVE BUDGETS OF OPERATING EXPENSES FOR PHASES 1 – 2 (FOR
ILLUSTRATIVE PURPOSES ONLY)**

See attached.

**Mackenzie Village Selkirks and Monashees Phase 1 and 2
PROPOSED OPERATING BUDGET**

ACCOUNT TITLE	BUDGET	PROPOSED
	<i>Phase 1</i>	<i>Phase 1 & 2</i>
<u>REVENUE</u>		
Maintenance Fee Revenue	\$ 499,923.60	\$ 963,965.20
Interest Income	0.00	0.00
TOTAL REVENUE	\$ 499,923.60	\$ 963,965.20
<u>EXPENSES</u>		
Administration		
Audit Fees	\$ 375.00	\$ 750.00
Insurance	98,000.00	178,500.00
Insurance Appraisal	700.00	1,400.00
Telephone & Internet	2,250.00	4,500.00
Professional Fees	2,250.00	4,500.00
Management Fees	28,950.00	57,900.00
Photocopy / Postage / Courier	1,500.00	3,000.00
Miscellaneous	1,250.00	2,500.00
Total Administration	135,275.00	253,050.00
Building		
Carpet Cleaning	1,500.00	3,000.00
Window Cleaning	3,750.00	7,500.00
Fire Alarm Monitoring	1,000.00	2,000.00
Fire Equipment Maintenance	2,500.00	5,000.00
Gutter Cleaning	3,500.00	7,000.00
Pest Control	1,250.00	2,500.00
Elevator	28,500.00	57,000.00
Dryer Vent Cleaning	3,250.00	5,500.00
Janitorial Services	48,900.00	78,900.00
Supplies	1,500.00	1,000.00
Emergency Generator	2,500.00	5,000.00
Security	3,500.00	25,500.00
R&M Interior	7,500.00	15,000.00
R&M - General	19,251.00	38,502.00
Total Building	128,401.00	253,402.00
Utilities		
Electricity	42,500.00	80,000.00
Garbage Disposal	22,500.00	45,000.00
Water & Sewage	48,500.00	96,000.00
Total Utilities	113,500.00	221,000.00
Grounds Maintenance		
Landscaping	42,000.00	78,000.00
Irrigation	1,250.00	2,500.00
Snow Removal	16,250.00	32,500.00
Tree Maintenance	2,500.00	5,000.00
Contribution to MV Community Association for Road and Trail System and Bus Service	11,800.00	23,880.00
Total Grounds Maintenance	73,800.00	141,880.00
Recreation Area		

Amenity Maintenance	3,500.00	7,000.00
Spa Chemicals and Maintenance	<u>1,850.00</u>	<u>3,700.00</u>
Total Recreation Area	3,500.00	7,000.00
TOTAL EXPENSES	\$ 454,476.00	\$ 876,332.00
Transfer to CRF	\$ <u>45,447.60</u>	\$ <u>87,633.20</u>
TOTAL EXPENSES & TRANSFERS	\$ 499,923.60	\$ 963,965.20
CURRENT YR OP SURPLUS (DEFICIT)	\$ <u>0.00</u>	\$ <u>0.00</u>
OPENING BALANCE OP SURPLUS (DEFICIT)	\$ <u> </u>	\$ <u> </u>
ENDING BALANCE OP SURPLUS (DEFICIT)	\$ <u><u>0.00</u></u>	\$ <u><u>0.00</u></u>

EXHIBIT G-1
ESTIMATED MONTHLY ASSESSMENTS – PHASE 1

See attached.

**Mackenzie Village Selkirks and Monashees Phase 1
PROPOSED FEE SCHEDULE**

S.L.	UNIT	U/E	OPERATING FUND CONTRIBUTION	CRF FUND CONTRIBUTION	TOTAL MONTHLY FEES DUE
1		122	425.31	42.53	467.84
2		117	407.87	40.79	448.66
3		117	407.87	40.79	448.66
4		130	453.19	45.32	498.51
5		131	456.68	45.67	502.35
6		117	407.87	40.79	448.66
7		117	407.87	40.79	448.66
8		123	428.79	42.88	471.67
9		123	428.79	42.88	471.67
10		117	407.87	40.79	448.66
11		157	547.32	54.73	602.05
12		131	456.68	45.67	502.35
13		117	407.87	40.79	448.66
14		61	212.65	21.27	233.92
15		90	313.75	31.38	345.13
16		88	306.78	30.68	337.46
17		121	421.82	42.18	464.00
18		90	313.75	31.38	345.13
19		90	313.75	31.38	345.13
20		120	418.34	41.83	460.17
21		121	421.82	42.18	464.00
22		61	212.65	21.27	233.92
23		90	313.75	31.38	345.13
24		88	306.78	30.68	337.46
25		121	421.82	42.18	464.00
26		90	313.75	31.38	345.13
27		90	313.75	31.38	345.13
28		120	418.34	41.83	460.17
29		121	421.82	42.18	464.00
30		65	226.60	22.66	249.26
31		66	230.08	23.01	253.09
32		88	306.78	30.68	337.46
33		121	421.82	42.18	464.00
34		91	317.24	31.72	348.96
35		91	317.24	31.72	348.96
36		120	418.34	41.83	460.17
37		121	421.82	42.18	464.00
38		65	226.60	22.66	249.26
39		66	230.08	23.01	253.09
40		88	306.78	30.68	337.46
41		121	421.82	42.18	464.00
42		90	313.75	31.38	345.13
43		90	313.75	31.38	345.13
44		120	418.34	41.83	460.17
45		121	421.82	42.18	464.00
46		61	212.65	21.27	233.92
47		90	313.75	31.38	345.13
48		90	313.75	31.38	345.13
49		121	421.82	42.18	464.00
50		90	313.75	31.38	345.13
51		90	313.75	31.38	345.13
52		120	418.34	41.83	460.17
53		121	421.82	42.18	464.00
54		61	212.65	21.27	233.92
55		90	313.75	31.38	345.13
56		88	306.78	30.68	337.46
57		121	421.82	42.18	464.00

**Mackenzie Village Selkirks and Monashees Phase 1
PROPOSED FEE SCHEDULE**

S.L.	UNIT	U/E	OPERATING FUND CONTRIBUTION	CRF FUND CONTRIBUTION	TOTAL MONTHLY FEES DUE
58		90	313.75	31.38	345.13
59		90	313.75	31.38	345.13
60		119	414.85	41.48	456.33
61		121	421.82	42.18	464.00
62		86	299.81	29.98	329.79
63		135	470.63	47.06	517.69
64		137	477.60	47.76	525.36
65		102	355.58	35.56	391.14
66		136	474.11	47.41	521.52
67		106	369.53	36.95	406.48
68		122	425.31	42.53	467.84
69		117	407.87	40.79	448.66
70		117	407.87	40.79	448.66
71		130	453.19	45.32	498.51
72		131	456.68	45.67	502.35
73		117	407.87	40.79	448.66
74		117	407.87	40.79	448.66
75		123	428.79	42.88	471.67
76		123	428.79	42.88	471.67
77		117	407.87	40.79	448.66
78		157	547.32	54.73	602.05
79		131	456.68	45.67	502.35
80		117	407.87	40.79	448.66
81		61	212.65	21.27	233.92
82		90	313.75	31.38	345.13
83		88	306.78	30.68	337.46
84		121	421.82	42.18	464.00
85		90	313.75	31.38	345.13
86		90	313.75	31.38	345.13
87		120	418.34	41.83	460.17
88		121	421.82	42.18	464.00
89		61	212.65	21.27	233.92
90		90	313.75	31.38	345.13
91		88	306.78	30.68	337.46
92		121	421.82	42.18	464.00
93		90	313.75	31.38	345.13
94		90	313.75	31.38	345.13
95		120	418.34	41.83	460.17
96		121	421.82	42.18	464.00
97		86	299.81	29.98	329.79
98		135	470.63	47.06	517.69
99		137	477.60	47.76	525.36
100		102	355.58	35.56	391.14
101		135	470.63	47.06	517.69
102		106	369.53	36.95	406.48
TOTAL U/E		10,852	37,831.30	3,783.24	41,614.54
			x 12	x 12	x 12
			453,975.60	45,398.88	499,374.48

EXHIBIT H

**ESTIMATED CUMULATIVE ASSESSMENTS FOR PHASES 1 – 2
(FOR ILLUSTRATIVE PURPOSES ONLY)**

See attached.

**Mackenzie Village Selkirks and Monashees Phase 1 and 2
PROPOSED FEE SCHEDULE**

S.L.	UNIT	U/E	OPERATING FUND CONTRIBUTION	CRF FUND CONTRIBUTION	TOTAL MONTHLY FEES DUE
1		122	410.55	41.06	451.61
2		117	393.73	39.37	433.10
3		117	393.73	39.37	433.10
4		130	437.47	43.75	481.22
5		131	440.84	44.08	484.92
6		117	393.73	39.37	433.10
7		117	393.73	39.37	433.10
8		123	413.92	41.39	455.31
9		123	413.92	41.39	455.31
10		117	393.73	39.37	433.10
11		157	528.34	52.83	581.17
12		131	440.84	44.08	484.92
13		117	393.73	39.37	433.10
14		61	205.27	20.53	225.80
15		90	302.86	30.29	333.15
16		88	296.14	29.61	325.75
17		121	407.18	40.72	447.90
18		90	302.86	30.29	333.15
19		90	302.86	30.29	333.15
20		120	403.82	40.38	444.20
21		121	407.18	40.72	447.90
22		61	205.27	20.53	225.80
23		90	302.86	30.29	333.15
24		88	296.14	29.61	325.75
25		121	407.18	40.72	447.90
26		90	302.86	30.29	333.15
27		90	302.86	30.29	333.15
28		120	403.82	40.38	444.20
29		121	407.18	40.72	447.90
30		65	218.74	21.87	240.61
31		66	222.10	22.21	244.31
32		88	296.14	29.61	325.75
33		121	407.18	40.72	447.90
34		91	306.23	30.62	336.85
35		91	306.23	30.62	336.85
36		120	403.82	40.38	444.20
37		121	407.18	40.72	447.90
38		65	218.74	21.87	240.61
39		66	222.10	22.21	244.31
40		88	296.14	29.61	325.75
41		121	407.18	40.72	447.90
42		90	302.86	30.29	333.15
43		90	302.86	30.29	333.15
44		120	403.82	40.38	444.20
45		121	407.18	40.72	447.90
46		61	205.27	20.53	225.80
47		90	302.86	30.29	333.15
48		90	302.86	30.29	333.15
49		121	407.18	40.72	447.90
50		90	302.86	30.29	333.15
51		90	302.86	30.29	333.15

**Mackenzie Village Selkirks and Monashees Phase 1 and 2
PROPOSED FEE SCHEDULE**

S.L.	UNIT	U/E	OPERATING FUND CONTRIBUTION	CRF FUND CONTRIBUTION	TOTAL MONTHLY FEES DUE
52		120	403.82	40.38	444.20
53		121	407.18	40.72	447.90
54		61	205.27	20.53	225.80
55		90	302.86	30.29	333.15
56		88	296.14	29.61	325.75
57		121	407.18	40.72	447.90
58		90	302.86	30.29	333.15
59		90	302.86	30.29	333.15
60		119	400.45	40.05	440.50
61		121	407.18	40.72	447.90
62		86	289.41	28.94	318.35
63		135	454.30	45.43	499.73
64		137	461.03	46.10	507.13
65		102	343.25	34.32	377.57
66		136	457.66	45.77	503.43
67		106	356.71	35.67	392.38
68		122	410.55	41.06	451.61
69		117	393.73	39.37	433.10
70		117	393.73	39.37	433.10
71		130	437.47	43.75	481.22
72		131	440.84	44.08	484.92
73		117	393.73	39.37	433.10
74		117	393.73	39.37	433.10
75		123	413.92	41.39	455.31
76		123	413.92	41.39	455.31
77		117	393.73	39.37	433.10
78		157	528.34	52.83	581.17
79		131	440.84	44.08	484.92
80		117	393.73	39.37	433.10
81		61	205.27	20.53	225.80
82		90	302.86	30.29	333.15
83		88	296.14	29.61	325.75
84		121	407.18	40.72	447.90
85		90	302.86	30.29	333.15
86		90	302.86	30.29	333.15
87		120	403.82	40.38	444.20
88		121	407.18	40.72	447.90
89		61	205.27	20.53	225.80
90		90	302.86	30.29	333.15
91		88	296.14	29.61	325.75
92		121	407.18	40.72	447.90
93		90	302.86	30.29	333.15
94		90	302.86	30.29	333.15
95		120	403.82	40.38	444.20
96		121	407.18	40.72	447.90
97		86	289.41	28.94	318.35
98		135	454.30	45.43	499.73
99		137	461.03	46.10	507.13
100		102	343.25	34.32	377.57
101		135	454.30	45.43	499.73
102		106	356.71	35.67	392.38

**Mackenzie Village Selkirks and Monashees Phase 1 and 2
PROPOSED FEE SCHEDULE**

S.L.	UNIT	U/E	OPERATING FUND CONTRIBUTION	CRF FUND CONTRIBUTION	TOTAL MONTHLY FEES DUE
103		122	410.55	41.06	451.61
104		117	393.73	39.37	433.10
105		117	393.73	39.37	433.10
106		130	437.47	43.75	481.22
107		131	440.84	44.08	484.92
108		117	393.73	39.37	433.10
109		117	393.73	39.37	433.10
110		123	413.92	41.39	455.31
111		123	413.92	41.39	455.31
112		117	393.73	39.37	433.10
113		157	528.34	52.83	581.17
114		131	440.84	44.08	484.92
115		117	393.73	39.37	433.10
116		61	205.27	20.53	225.80
117		90	302.86	30.29	333.15
118		88	296.14	29.61	325.75
119		121	407.18	40.72	447.90
120		90	302.86	30.29	333.15
121		90	302.86	30.29	333.15
122		120	403.82	40.38	444.20
123		121	407.18	40.72	447.90
124		61	205.27	20.53	225.80
125		90	302.86	30.29	333.15
126		88	296.14	29.61	325.75
127		121	407.18	40.72	447.90
128		90	302.86	30.29	333.15
129		90	302.86	30.29	333.15
130		120	403.82	40.38	444.20
131		121	407.18	40.72	447.90
132		86	289.41	28.94	318.35
133		135	454.30	45.43	499.73
134		137	461.03	46.10	507.13
135		102	343.25	34.32	377.57
136		135	454.30	45.43	499.73
137		106	356.71	35.67	392.38
138		65	218.74	21.87	240.61
139		66	222.10	22.21	244.31
140		88	296.14	29.61	325.75
141		121	407.18	40.72	447.90
142		91	306.23	30.62	336.85
143		91	306.23	30.62	336.85
144		120	403.82	40.38	444.20
145		121	407.18	40.72	447.90
146		65	218.74	21.87	240.61
147		66	222.10	22.21	244.31
148		88	296.14	29.61	325.75
149		121	407.18	40.72	447.90
150		90	302.86	30.29	333.15
151		90	302.86	30.29	333.15
152		119	400.45	40.05	440.50
153		120	403.82	40.38	444.20

**Mackenzie Village Selkirks and Monashees Phase 1 and 2
PROPOSED FEE SCHEDULE**

S.L.	UNIT	U/E	OPERATING FUND CONTRIBUTION	CRF FUND CONTRIBUTION	TOTAL MONTHLY FEES DUE
154		61	205.27	20.53	225.80
155		90	302.86	30.29	333.15
156		88	296.14	29.61	325.75
157		121	407.18	40.72	447.90
158		90	302.86	30.29	333.15
159		90	302.86	30.29	333.15
160		120	403.82	40.38	444.20
161		121	407.18	40.72	447.90
162		61	205.27	20.53	225.80
163		90	302.86	30.29	333.15
164		88	296.14	29.61	325.75
165		121	407.18	40.72	447.90
166		90	302.86	30.29	333.15
167		90	302.86	30.29	333.15
168		120	403.82	40.38	444.20
169		121	407.18	40.72	447.90
170		86	289.41	28.94	318.35
171		135	454.30	45.43	499.73
172		137	461.03	46.10	507.13
173		102	343.25	34.32	377.57
174		136	457.66	45.77	503.43
175		106	356.71	35.67	392.38
176		122	410.55	41.06	451.61
177		117	393.73	39.37	433.10
178		117	393.73	39.37	433.10
179		130	437.47	43.75	481.22
180		131	440.84	44.08	484.92
181		117	393.73	39.37	433.10
182		117	393.73	39.37	433.10
183		123	413.92	41.39	455.31
184		123	413.92	41.39	455.31
185		117	393.73	39.37	433.10
186		157	528.34	52.83	581.17
187		131	440.84	44.08	484.92
188		117	393.73	39.37	433.10
189		61	205.27	20.53	225.80
190		90	302.86	30.29	333.15
191		88	296.14	29.61	325.75
192		121	407.18	40.72	447.90
193		90	302.86	30.29	333.15
194		90	302.86	30.29	333.15
195		120	403.82	40.38	444.20
196		121	407.18	40.72	447.90
197		61	205.27	20.53	225.80
198		90	302.86	30.29	333.15
199		88	296.14	29.61	325.75
200		121	407.18	40.72	447.90
201		90	302.86	30.29	333.15
202		90	302.86	30.29	333.15
203		120	403.82	40.38	444.20
204		121	407.18	40.72	447.90

**Mackenzie Village Selkirks and Monashees Phase 1 and 2
PROPOSED FEE SCHEDULE**

S.L.	UNIT	U/E	OPERATING FUND CONTRIBUTION	CRF FUND CONTRIBUTION	TOTAL MONTHLY FEES DUE
TOTAL U/E		21,701	73,027.42	7,302.76	80,330.18
			x 12	x 12	x 12
			876,329.04	87,633.12	963,962.16

EXHIBIT I

PROPOSED FORM OF PURCHASE AGREEMENT – PHASE 1

See attached.

THE SELKIRKS AND MONASHEES AT MACKENZIE VILLAGE
CONTRACT OF PURCHASE AND SALE

"Vendor" 0929468 B.C. Ltd.
Suite 900 - 900 West Hastings Street, Vancouver, B.C., V6C 1E5
Phone: (604) 932-9835 E-mail: david@mackenzievillage.ca

"Purchaser"	_____	_____
	_____	_____
	_____	_____
Tel: (H):	_____	Tel: (H):
Tel: (W):	_____	Tel: (W):
Tel: (C):	_____	Tel: (C):
Fax:	_____	Fax:
E-mail:	_____	E-mail:
	_____	_____
Occupation/Principal Business:	_____	Occupation/Principal Business:
	_____	_____
Canadian Citizen/Permanent Resident:	_____	Canadian Citizen/Permanent Resident:
<input type="checkbox"/> Yes / <input type="checkbox"/> No _____	_____	<input type="checkbox"/> Yes / <input type="checkbox"/> No _____
(Country of Citizenship/Residency)	_____	(Country of Citizenship/Residency)
Passport / ID No.	_____	Passport / ID No.
Date of Birth:	_____	Date of Birth:
	_____	_____

"Strata Lot" Proposed **Strata Lot** _____ (**Unit No.** _____) in **Phase 1** of a development (the "**Development**") known as "The Selkirks and Monashees at Mackenzie Village" to be constructed within a parcel to be subdivided from a portion of the lands (the "**Lands**") located at 1701 Coursier Avenue, Revelstoke, British Columbia and currently legally described as Parcel Identifier: 030-260-833, Lot 2, Section 23, Township 23, Range 2 West of the 6th Meridian, Kootenay District, Plan EPP69441 Except Plan EPP98511.

"Purchase Price" \$ _____ (plus any amount payable for upgrades and other extras). The Purchaser acknowledges and agrees that the Purchase Price is exclusive of applicable taxes (including goods and services tax ("**GST**") or any other federal or provincial sales, service, value added, transition or other tax, as set out in further detail in section 13 of Schedule A)).

1.01 Offer. The Purchaser hereby offers to purchase the Strata Lot from the Vendor for the Purchase Price and upon the terms set forth herein subject to the encumbrances (the "**Permitted Encumbrances**") referred to in the Disclosure Statement (as defined in section 26 of Schedule A). The Purchaser acknowledges that he/she/it is purchasing a strata lot which is to be constructed or is presently under construction.

1.02 Deposit. The Purchaser will pay deposits to Terra Law Corporation, (the "**Vendor's Solicitors**") in trust to be held by them as trustee in accordance with the *Real Estate Development Marketing Act* (British Columbia) ("**REDMA**") as follows:

- a. an initial deposit (the "**First Deposit**") by credit card via Avesdo, certified cheque or bank draft due upon presentation of this offer to the Vendor; \$1,000.00

INITIALS	

- b. a second deposit (the **“Second Deposit”**) equal to 5% of the Purchase Price, less the amount of the First Deposit (for clarity, the combined amount of the First Deposit and the Second Deposit will equal no more than 5% of the Purchase Price), payable by certified cheque or bank draft on or before the date that is 7 days after the Acceptance Date (as defined below); \$ _____
- c. a third deposit (the **“Third Deposit”**) equal to 5% of the Purchase Price, payable by certified cheque or bank draft on or before the date that is the earlier of: (i) 10 days after receipt by the Purchaser of the Building Permit Amendment and the Financing Amendment (each as defined in section 26 of Schedule A hereto); and (ii) 30 days following the Acceptance Date; and \$ _____
- d. a fourth deposit (the **“Fourth Deposit”**) equal to an additional 5% of the Purchase Price, payable by certified cheque or bank draft on or before the date that is the later of: (i) 10 days after receipt by the Purchaser of the Building Permit Amendment and the Financing Amendment (each as defined in section 26 of Schedule A hereto); and (ii) 90 days following the Acceptance Date. \$ _____

The First Deposit, Second Deposit, Third Deposit and Fourth Deposit are collectively referred to herein as the **“Deposit”**.

The Purchaser will pay the balance of the Purchase Price, subject to adjustments described herein, on the Completion Date (as defined in section 1 of Schedule A) by way of certified solicitor’s trust cheque or bank draft.

1.03 Included Items. The Purchase Price includes the following items unless otherwise noted in the Disclosure Statement:

- [a] Oven
- [b] Electric Cook Top
- [c] Dishwasher
- [d] Refrigerator
- [e] Washer and Dryer
- [f] Microwave and Hood Fan
- [g] Electric Hot Water Tank
- [h] Heat Pump or VRV/VRF/split system for heating and cooling (or such other heating and cooling equipment as may be determined by the Developer in its sole discretion)

Fixtures and features as represented in the Disclosure Statement will also be included, provided that the Vendor may substitute materials and brands of reasonably similar or better quality. Presentation Centre / Display Suite decorator features, fixtures, wall treatments, finishings, fittings, mill work, light fixtures and furnishings are not included in the Purchase Price.

The Purchase Price includes the right to the exclusive use of the following number of parking stall(s) and storage locker(s) located within the Development to be allocated in the manner described in the Disclosure Statement: The Vendor reserves the right to determine the location of any parking stall or storage locker allocated to the Purchaser in the Vendor’s sole discretion without consultation with the Purchaser and, if more than one parking stall is to be allocated to the Purchaser, such parking stalls may be allocated by the Vendor to the Purchaser in tandem design. The parking stalls in the Development may vary in size, shape and convenience of location, and may be partially obstructed by equipment and other facilities.

Initial Applicable Box

_____ parking stalls (s)

Purchaser	Purchaser	Vendor
-----------	-----------	--------

_____ storage locker(s)

Purchaser	Purchaser	Vendor
-----------	-----------	--------

1.04 Colour Scheme. The Purchaser selects the following colour scheme for the Strata Lot:

- Forest After Dark **OR** Alpine Sunset

INITIALS	

1.05 Completion, Possession and Adjustment Dates. See Schedule A attached hereto.

1.06 Receipt of Disclosure Statement. The Purchaser acknowledges that the Purchaser has received a copy of the Consolidated Disclosure Statement (as defined in section 26 of Schedule A hereto) for the Development and has been given a reasonable opportunity to read the Consolidated Disclosure Statement prior to entering into this Contract and the execution by the Purchaser of this Contract will constitute a receipt in respect thereof. The Purchaser acknowledges that the information in section 7.2 of the Disclosure Statement regarding this Contract has been drawn to the Purchaser's attention.

INITIALS	

1.07 Electronic Delivery of Disclosure Statement and Amendments. To the extent that the Vendor provided a copy of the Initial Disclosure Statement (as defined in section 26 of Schedule A hereto), the Consolidated Disclosure Statement, or any or all of the amendments to disclosure statement to the Purchaser by electronic means, including, without limitation, by e-mail to the e-mail address set out on page 1 hereof, the Purchaser hereby consents to such delivery by electronic means. The Purchaser hereby acknowledges and agrees that the Vendor may, in its discretion, deliver a copy of any amendment to disclosure statement which is filed in respect of the Disclosure Statement, including, without limitation, the Building Permit Amendment or the Financing Amendment, to the Purchaser by electronic means, including, without limitation, by e-mail to the e-mail address set out on page 1 hereof, and the Purchaser hereby consents to such delivery by electronic means. Any other communication or document to be given by the Vendor will be well and sufficiently given if sent by e-mail to the Purchaser to the e-mail address set out on page 1.

INITIALS	

1.08 Acceptance. The Purchaser's offer herein will be open for acceptance by the Vendor on presentation until 11:59 p.m. the third day after the date of execution of this offer by the Purchaser and upon acceptance by the Vendor signing a copy of this offer, there will be a binding agreement of sale (the "**Contract**") and purchase in respect of the Strata Lot for the Purchase Price, on the terms and subject to the conditions set out herein. The date on which this Contract is duly executed and delivered by each of the Vendor and the Purchaser is referred to herein as the "**Acceptance Date**".

This Contract is dated for reference _____, 202____.

THE TERMS AND CONDITIONS ATTACHED HERETO AS SCHEDULE A ARE PART OF THIS CONTRACT.

THE PURCHASER HAS EXECUTED THIS CONTRACT THIS _____ DAY OF _____, 202____.

WITNESS: _____ PURCHASER(S): _____
(seal)

(seal)

VENDOR'S ACCEPTANCE: The Vendor hereby accepts the Purchaser's offer to purchase contained herein this _____ day of _____ 202____

0929468 B.C. LTD.

By: _____
(Authorized Signatory)

SCHEDULE A

1. Completion Date. The Purchaser will pay the balance of the Purchase Price, as adjusted in accordance with this Contract, by way of a SOLICITOR'S CERTIFIED TRUST CHEQUE or BANK DRAFT by NO LATER THAN 2:00 p.m. on the completion date (the "**Completion Date**"), which will be the date identified by written notice given by the Vendor or the Vendor's Solicitors to the Purchaser or the Purchaser's solicitors/notary (the "**Purchaser's Solicitors**") as a date on which the Strata Lot is or will be ready to be occupied, provided the Vendor or the Vendor's Solicitors will give not less than 10 days' notice thereof. Whether the Strata Lot is ready to be occupied refers to the Strata Lot and not any other strata lot or common property within the Development and the Strata Lot will be deemed to be ready to be occupied on the Completion Date if (i) the City of Revelstoke (the "**City**") has given permission to occupy the Strata Lot, whether such permission is temporary, conditional or final and (ii) the applicable land title office (the "**LTO**") has issued a separate title for the Strata Lot. If the Completion Date is a Saturday, Sunday, statutory holiday or a day upon which the LTO is not open for business, the Completion Date will be the immediate following day on which the LTO is open for business. The notice of the Completion Date given by the Vendor or the Vendor's Solicitors to the Purchaser or the Purchaser's Solicitors may be based on the Vendor's estimate as to when the Strata Lot will be ready to be occupied. If the Strata Lot is not ready to be occupied on the Completion Date so established, then the Vendor may delay the Completion Date from time to time as required, by written notice of such delay to the Purchaser or the Purchaser's Solicitors. If the Completion Date has not occurred by December 31, 2026 (the "**Outside Date**"), then this Contract will terminate on the Outside Date, the Deposit will be returned to the Purchaser and the parties will be released from all of their obligations hereunder, provided that:

- (a) if the Vendor is delayed from completing construction of the Strata Lot as a result of epidemic, pandemic, earthquake, flood or other act of God, fire, explosion, terrorism or accident, howsoever caused, act of any governmental authority, strike, lockout, inability to obtain or delay in obtaining labour, supplies, materials or equipment, delay or failure by carriers or contractors, breakage or other casualty, climactic condition, interference of the Purchaser, or any other event of any nature whatsoever beyond the reasonable control of the Vendor, then the Vendor may, at its option, exercisable by written notice to the Purchaser, in addition to any extension pursuant to subsection 1(b) and whether or not any extension described in subsection 1(b) has been exercised, elect to extend the Outside Date by a period equivalent to such period of delay; and
- (b) the Vendor may, at its option, exercisable by written notice to the Purchaser, in addition to any extension pursuant to subsection 1(a) and whether or not any extension described in subsection 1(a) has been exercised, elect to extend the Outside Date for up to 120 days.

The Purchaser acknowledges that the estimated date range for completion of construction set out in the Disclosure Statement has been provided by the Vendor as a matter of convenience only, is not meant to be legally binding upon the Vendor and that the actual Completion Date will be established in the manner set out above.

2. Conveyance. The Purchaser will cause the Purchaser's Solicitors to prepare and deliver to the Vendor's Solicitors at least five days prior to the Completion Date a statement of adjustments and a Freehold Transfer (the "**Transfer**") for the Strata Lot. The Vendor will execute and deliver, or cause to be executed and delivered, the Transfer and the statement of adjustments to the Purchaser's Solicitors on or before the Completion Date on the condition that, forthwith upon the Purchaser's Solicitors obtaining a post registration index search from the LTO indicating that, in the ordinary course of LTO procedure, the Purchaser will become the registered owner of the Strata Lot (subject only to the Permitted Encumbrances and charges for which the Purchaser is responsible), the Purchaser will cause payment of the adjusted balance of the Purchase Price due on the Completion Date to be made by the Purchaser's Solicitors to the Vendor's Solicitors. The transfer of the Strata Lot will also be subject to the Vendor's financing arranged in connection with the Development or any builders' lien claims provided that the Vendor's Solicitors undertake to clear title to the Strata Lot of all encumbrances related to such financing and such builders' liens claims within a reasonable period of time after receiving the balance of the Purchase Price due on the Completion Date. The Purchaser acknowledges that the Vendor's financing may remain as a charge against the common property of the Development until the Vendor has completed the sale of the balance of the strata lots in the Development whereupon the Vendor covenants such financing will be discharged entirely.

If the Purchaser is relying upon a new mortgage to finance the Purchase Price, the Purchaser, while still required to pay the Purchase Price on the Completion Date, may wait to pay the Purchase Price to the Vendor until after the Transfer and new mortgage documents have been lodged for registration in the LTO, but only if, before such lodging, the Purchaser has: (a) made available for tender to the Vendor that portion of the Purchase Price not secured by the new mortgage; and (b) fulfilled all the new mortgagee's conditions for funding except lodging the mortgage for registration; and (c) made available to the Vendor a solicitor's or notary's undertaking to pay the Purchase Price upon the lodging of the Transfer and new mortgage documents and the advance by the mortgagee of the mortgage proceeds.

INITIALS	

3. **Deposit.** The Deposit will be dealt with as follows:

- (a) The Deposit, or any portion thereof, when received, will be deposited by the Vendor's Solicitors in an interest bearing trust account with the interest to accrue to the benefit of the Vendor.
- (b) The Vendor and the Purchaser agree that the total amount of the Deposit (including all portions thereof, whether paid or unpaid) together with interest thereon constitutes a genuine pre-estimate of the damages the Vendor will suffer as a result of the Purchaser's failure to pay any portion of the Deposit when required hereunder or failure to complete the purchase of the Strata Lot in default of its obligations hereunder. If the Purchaser fails to pay any portion of the Deposit when required hereunder or fails to complete the purchase of the Strata Lot in default of his/her/its/their obligations hereunder, then subject to section 7(b) of this Schedule A, the Vendor may elect to terminate this Contract and, in such event, the portion of the Deposit that has been paid together with interest thereon will be absolutely forfeited to the Vendor as liquidated damages, without prejudice to any other remedy which the Vendor may have in respect of the Purchaser's default including, without limitation, the right of the Vendor to pursue the Purchaser for any unpaid balance of the Deposit and to seek additional damages.
- (c) If the Vendor fails to complete the sale of the Strata Lot, then the Deposit paid will be paid to the Purchaser, together with any interest earned thereon, as the Purchaser's sole and exclusive remedy in accordance with section 8.

The Purchaser acknowledges that any payment made by the Purchaser that is returned for non-sufficient funds will be subject to a service charge equal to the amount charged by the applicable financial institution. The Purchaser acknowledges that the Vendor may appoint replacement solicitors for the Vendor's Solicitors and/or cause the Deposit paid and subsequent payments on account of the Deposit to be transferred to the trust account of such replacement solicitors or another trustee (as defined in REDMA), in either case upon written notice to the Purchaser.

Notwithstanding the foregoing, the Purchaser acknowledges and agrees that, in accordance with Section 19 of REDMA, the Vendor may enter into a deposit protection contract (the "**Deposit Protection Contract**") with an approved insurer, pursuant to which the deposits paid by purchasers of strata lots in the Development, including the Deposit, are insured and, as such, may be released by the Vendor's Solicitors, in whole or in part, to the Vendor and the Vendor may use such deposits for purposes related to the Development, including without limitation, the construction and marketing of the Development in accordance with the provisions of REDMA. Upon the release of the Deposit or any portion thereof to the Vendor in accordance with the Deposit Protection Contract, the provisions of this Contract will be deemed to have been amended accordingly. The Purchaser acknowledges that from and after the release of the Deposit or any portion thereof pursuant to a Deposit Protection Contract, no further interest will be earned on the amount so released.

4. **Possession, Risk and Adjustment.** The Purchaser will assume all taxes, rates, local improvement assessments, water rates and scavenging rates, assessments of the strata corporation (the "**Strata Corporation**") of which the Strata Lot forms a part, and all other adjustments both incoming and outgoing of whatever nature in respect of the Strata Lot, including an adjustment to credit the Vendor with the Purchaser's share of the prepaid insurance premium for the Strata Corporation, will be made as of the Completion Date. The Strata Lot will be at the risk of the Vendor to and including the day preceding the Completion Date, and thereafter at the risk of the Purchaser. So long as the Purchase Price and all other amounts payable by the Purchaser to the Vendor in respect of the Strata Lot have been paid in full, the Purchaser may have possession of the Strata Lot on the day following the Completion Date (the "**Possession Date**").

The Purchaser is responsible for all utility charges as of the Possession Date and must ensure that he/she/it notifies the necessary utility companies to have the utilities transferred into his/her/its/their name on the Possession Date. In the event the Purchaser does not transfer the utilities into his/her/its/their name as of the Possession Date, any charges to the Vendor that should be the Purchaser's responsibility will be paid to the Vendor in full within five Business Days (as defined in section 28 of this Schedule A) after notification thereof from the Vendor. If said amount is not paid within the five Business Day period, then an initial charge of \$50.00, plus a further charge of \$50.00 each month thereafter, will be applied to the outstanding amount until such amount and such charges are paid in full by the Purchaser.

5. **Builders' Lien Holdback.** That portion, if any, of the balance of the Purchase Price required by law to be held back by the Purchaser in respect of builders' lien claims (the "**Lien Holdback**") will be paid to the Vendor's Solicitors on the Completion Date. The Lien Holdback will be held in trust for the Purchaser pursuant to the *Strata Property Act* (British Columbia) and *Builders Lien Act* (British Columbia) (or successor statutes) solely in respect of lien claims registered in

INITIALS	

the LTO in connection with work done at the behest of the Vendor. The Vendor's Solicitors are authorized to invest the Lien Holdback in an interest bearing trust account and to pay to the Vendor (or as directed by the Vendor), on the earlier of (i) the date on which the time for filing a claim of lien under the *Builders Lien Act* (British Columbia) expires; and (ii) the date which is 55 days after the date that the balance of the Purchase Price becomes due as aforesaid, the Lien Holdback plus interest, if any, accrued thereon, less the amount of any builders' lien claim filed against the Strata Lot of which the Purchaser or the Purchaser's Solicitors notify the Vendor's Solicitors in writing by 1:00 p.m. on that day. The Purchaser hereby authorizes the Vendor and the Vendor's Solicitors to do all things necessary to discharge any builders' liens, including bringing court proceedings in the name of the Purchaser, provided that any such proceedings will be at the sole expense of the Vendor.

- 6. **Vendor's Condition Precedent.** The obligation of the Vendor to complete the sale of the Strata Lot is subject to the Vendor obtaining construction financing in respect of Phase 1 that is satisfactory to the Vendor in its sole, absolute and unfettered discretion on or before December 19, 2023.

The foregoing condition is for the exclusive benefit of the Vendor and may be waived by the Vendor at any time on or prior to the time set forth for satisfaction of the same. The condition will be deemed to have been waived within the time set forth if the Purchaser has not received, within seven (7) days following the date on which such condition is to be satisfied, notification from the Vendor that such condition has not been satisfied or waived. In the event the Vendor provides notice within such seven (7) day period that such condition is not waived or satisfied, this Contract will be terminated, whereupon the Deposit will be forthwith returned to the Purchaser without deduction, and this Contract will thereupon be null and void, and of no further force or effect, and the Vendor will not be liable for any costs or damages suffered by the Purchaser as a result of or in connection with this Contract or as a direct or indirect result of its termination. In consideration of the amount of \$1.00 now paid by the Vendor to the Purchaser, the receipt and sufficiency of which is hereby acknowledged by the Purchaser, this Contract is irrevocable by the Purchaser notwithstanding the foregoing condition precedent.

- 7. **Time is of The Essence/Purchaser Default.** Time will be of the essence hereof. If the Purchaser fails to make any payment on account of the Purchase Price (including, without limitation, any portion of the Deposit or the balance of the Purchase Price), together with adjustments thereto as provided herein, when due or fails to pay any other amount payable hereunder when due, then the Vendor may, at its option:

- (a) terminate this Contract by written notice to the Purchaser and, in such event, the portion of the Deposit that has been paid and all interest accrued thereon will be absolutely forfeited to the Vendor as liquidated damages, the parties agreeing that the total amount of the Deposit (including all portions thereof, whether paid or unpaid) together with interest thereon constitutes a genuine pre-estimate of the damages the Vendor will suffer as a result of the Purchaser's failure to pay, when due, any payment on account of the Purchase Price, together with adjustments thereto as provided herein, or any other amounts payable hereunder, without prejudice to the Vendor's other remedies including, without limitation, the right of the Vendor to pursue the Purchaser for any unpaid balance of the Deposit and to seek additional damages and, subject to the provisions of REDMA, the Vendor's Solicitors are hereby irrevocably authorized and directed by the Purchaser to pay the amount held by them and such interest as may have accrued thereon to the Vendor upon written demand therefor by the Vendor; or
- (b) elect to extend the date for payment or the Completion Date, as applicable, to a certain date determined by the Vendor, time to remain of the essence hereof and subject to the Vendor's right in its sole discretion, to grant further extensions to a certain date each time, in which event the Purchaser will pay to the Vendor, in addition to the Purchase Price, interest on the unpaid portion of the Purchase Price and other unpaid amounts payable hereunder at the rate of 2% per month (26.82% per annum), calculated daily and compounded monthly not in advance, from the date upon which such portion and amounts were due to the date upon which such portion and amounts are paid.

The Vendor may cancel this Contract pursuant to subsection 7(a) of this Schedule A or grant one or more further extensions pursuant to subsection 7(b) of this Schedule A, at any time after extending the date for payment or the Completion Date, as the case may be, pursuant to subsection 7(b) of this Schedule A if the Purchaser fails to make such payment or complete the purchase of the Strata Lot, as the case may be, in accordance with this Contract on or before such extended date.

- 8. **Vendor's Default.** Notwithstanding anything else contained herein, the Purchaser acknowledges and agrees that any and all claims, whether in contract or tort, which the Purchaser has or hereafter may have against the Vendor in any way arising out of, or related to, the Strata Lot or the Vendor's obligations and covenants pursuant to this Contract will be limited to the amount paid by the Purchaser on account of the Deposit. The Purchaser acknowledges and agrees

INITIALS	

that if the Vendor fails to complete the sale of the Strata Lot in default of its obligations hereunder, then the Deposit will be repaid to the Purchaser as liquidated damages as the Purchaser's sole and exclusive remedy and the Purchaser will have no further claims whatsoever against the Vendor in respect of such default and the Vendor will have no further obligations or liabilities whatsoever hereunder, and the Purchaser hereby releases and discharges the Vendor from any claim beyond the amount of the Deposit. The Purchaser acknowledges and agrees that the Vendor will not be liable for any damages or costs whatsoever beyond the amount of the Deposit which may be incurred by the Purchaser resulting from any such failure including, without limiting the generality of the foregoing, relocation costs, professional fees and disbursements, opportunity costs, loss of bargain, damages and/or costs resulting from hardship or any other damages or costs incurred by the Purchaser, directly or indirectly, as a result of the Vendor's default.

9. **Entire Contract/Representations.** The Purchaser acknowledges and agrees that this Contract constitutes the entire agreement between the parties with respect to the sale and purchase of the Strata Lot and supersedes any prior agreements, negotiations or discussions, whether oral or written, of the Vendor and the Purchaser, and that there are no representations, warranties, conditions or collateral contracts, expressed or implied, statutory or otherwise, or applicable hereto, made by the Vendor, its agents or employees, or any other person on behalf of the Vendor, including, without limitation, arising out of any sales brochures, models, websites, social media, blogs, Twitter, Facebook, representative view sets, showroom displays, photographs, illustrations or renderings or other marketing materials provided to the Purchaser or made available for his/her/its/their viewing other than those contained herein and in the Disclosure Statement. In particular, the Purchaser acknowledges and agrees that the materials, specifications, details, dimensions and floor plans set out in any materials viewed by the Purchaser are approximate and subject to change without notice in order to comply with building site conditions and municipal, structural and Vendor and/or architectural requirements.

10. **Construction.**

(a) The Vendor will cause the Strata Lot to be constructed and completed in a good and workmanlike manner substantially in accordance with the plans and specifications (the "**Plans and Specifications**") for the Development prepared by the Vendor's architect(s) for the Development (the "**Architect**") subject to any changes required by the City. The Vendor may make alterations to the features, design and layout of the Strata Lot which are desirable in the reasonable discretion of the Vendor and may use materials other than as prescribed in the Plans and Specifications if they are reasonably similar to what is prescribed. The Vendor reserves the right to alter the common property of the Development at any time and from time to time if, in its sole opinion, such alteration or alterations improve the structural integrity of the Development, its mechanical systems, its ability to withstand water penetration or aesthetics. The Purchaser is aware that the preliminary strata plan (the "**Preliminary Plan**") for the phase of the Development in which the Strata Lot is located, a copy of which Preliminary Plan is attached to the Disclosure Statement in Exhibit A, is based on architectural drawings and measurements. The actual size, dimensions and/or configuration of the Strata Lot including any balcony, patio or deck, as set forth in the final strata plan (the "**Final Strata Plan**") for the phase of the Development in which the Strata Lot is located may vary from what is depicted on the Preliminary Plan. The areas and dimensions of the strata lots (including the Strata Lot) in the Development set out in the marketing materials referred to in section 9 of this Schedule A, including balconies, patios and decks, are approximate, based on architectural drawings and provided for reference purposes only, and are not represented as being the actual final areas and dimensions. The Vendor represents and warrants that the actual area of the Strata Lot, as set forth in the Final Strata Plan, will be no more than 3% smaller than indicated in the Disclosure Statement when both measurements are calculated in accordance with the *Strata Property Act* (British Columbia). If the Strata Lot is more than 3% smaller, then the Purchase Price will be reduced by a percentage equal to the number of percent (rounded to the nearest one-hundredth of a percentage point) by which the Strata Lot is more than 3% smaller and for greater certainty, the foregoing will be the Purchaser's sole remedy in respect thereof.

(b) The Purchaser acknowledges that the Development will include service facilities and equipment required in connection therewith such as transformers, fire hydrants, vents, ducts, fans and other such facilities and equipment (the "**Service Facilities**"). The Service Facilities will be located within the Development as required by the City or recommended by the Vendor's consultants. The Purchaser acknowledges that the current plans for the Development may not indicate the location of all the Service Facilities and that the Vendor reserves the right to relocate, add or delete all or a portion of the Service Facilities as deemed necessary by the Vendor, without compensation to the Purchaser.

(c) The Purchaser will make the selection of colour scheme, materials and optional items (to the extent the Vendor permits such selection to be made) and pay any additional costs therefor, promptly when requested to do so by the Vendor. If the Purchaser fails to do so, the Vendor may make any such selection and the Purchaser will be bound thereby and will pay any additional costs associated with such selection.

INITIALS	

- (d) Due to the natural variation of colour and texture in any wood, stone, granite, and dye lots of any tile, carpet and other components of the Strata Lot and the fact that the colour of natural products (especially wood) will change over time, the finishes of any wood, granite, tile, stone, carpet and other components of the Strata Lot may differ from the colour, grain, vein, pattern, size, stain resistance and textures shown in the display unit or any samples provided to or viewed by the Purchaser. In addition, even within the Strata Lot, the textures, colours and finishes may vary for the same reasons. The variations are inherent characteristics which cannot be fully controlled and any such variations will not in any event be considered or deemed to be deficiencies in the Strata Lot.
- (e) The Purchaser acknowledges and agrees that the ceiling heights of all strata lots in the Development may vary from floor to floor and may have areas of the ceilings dropped down from the typical height of the ceilings in order to accommodate construction requirements including, but not limited to, mechanical, electrical equipment, ducting, ventilation systems, plumbing and structural requirements.

11. Purchaser Acknowledgements. The Purchaser acknowledges and agrees that:

- (a) the Deposit payment (or portion thereof) that is paid will not begin to bear interest until after it is deposited into the Vendor's Solicitors' trust account which may, in the Vendor's discretion, be after the expiry of all statutory rescission periods;
- (b) the municipal address(es) of the Development, the suite and strata lot number assigned to the Strata Lot and the number assigned to the floor in the Development on which the Strata Lot is located are subject to change as determined by the Vendor or the City;
- (c) the Completion Date may be any day up to and including the Outside Date, as extended pursuant to subsection 1(a) and 1(b) of this Schedule A and the Purchaser releases the Vendor and its affiliates from any actions, causes of action, costs, claims, demands and liabilities arising as a result of the date on which the Completion Date occurs;
- (d) in the event of any discrepancy between the strata lot number and suite number set out on page 1 of this Contract, the Strata Lot is the strata lot labelled on the Preliminary Plan with the strata lot number set out on page 1 of this Contract, as the same may change as contemplated in subsection 11(b);
- (e) the parking stalls and storage lockers in the Development, including any parking stall(s) and storage locker(s) to which the Purchaser is entitled hereunder, if any, will vary in size, shape and convenience of location, and the parking stalls and storage lockers in the Development, including any parking stall(s) and storage locker(s) to which the Purchaser is entitled hereunder, if any, may be partially obstructed by columns, pipes, ducts, mechanical equipment, electrical equipment and other facilities, and the Purchaser will accept any parking stall(s) and storage locker(s) to which the Purchaser is entitled hereunder, if any, on an "as is, where is" basis and will have no claim against the Vendor in respect of any variation in the size, shape or convenience of location of such parking stall(s) and / or storage locker(s) or any partial obstruction of such parking stall(s) and / or storage locker(s);
- (f) the Strata Lot forms a part of a phased development and the Purchaser understands and accepts that the Purchaser may be inconvenienced by ongoing construction activities relating to other phase(s) of the Development which may, from time to time, result in noise, vibrations, odours, dirt, dust and such other irritants that are associated with construction projects similar to the Development; and
- (g) it has read and understood the summary of the legal notations, covenants, easements, statutory rights of way and other encumbrances that are described in subsections 4.3 and 4.4 of the Disclosure Statement.

12. Inspection. The Vendor warrants that, on the Completion Date, the Strata Lot and the common property in completed phases of the Development will be registered under a third-party new home warranty provider. The Purchaser or his/her/its/their representative will have the right to inspect the Strata Lot with a representative of the Vendor at a reasonable time designated by the Vendor by written notice or by telephone prior to the Completion Date and a refusal or failure by the Purchaser to inspect the Strata Lot at such time will be deemed to be a waiver and forfeiture of such right, in which case the Purchaser will be deemed to be satisfied with and to have accepted the physical condition of the Strata Lot (including the existing kitchen, bathrooms and other installations, equipment, appliances and furnishings in the Strata Lot) on the Completion Date. At the conclusion of such inspection, the Vendor will prepare a conclusive list of any defects or deficiencies (the "Deficiencies") which are to be rectified by the Vendor. The parties will sign the list and the Purchaser will be deemed to be satisfied with and to have accepted the physical condition of the Strata Lot

INITIALS	

(including the existing kitchen, bathrooms and other installations, equipment, appliances and furnishings) subject only to the Deficiencies. If the Purchaser does not sign the Deficiencies list, the Purchaser will be deemed to be satisfied with and to have accepted the physical condition of the Strata Lot (including the existing kitchen, bathroom and other installations, equipment, appliances and furnishings). The Purchaser covenants and agrees to complete the purchase of the Strata Lot on the Completion Date on the terms and conditions herein contained notwithstanding that the Deficiencies may be rectified subsequent to the Completion Date. The Purchaser will not be allowed to have access to the Strata Lot except for this inspection prior to the Possession Date. No holdback will be made on closing in respect of the Deficiencies or other deficiencies. In the event of a disagreement between the Purchaser and the Vendor as to what constitutes a defect or deficiency, or whether or not a defect or deficiency has been rectified, the decision of the Architect or any replacement therefor appointed by the Vendor will be conclusive, final and binding on the parties. Following the Completion Date, the Purchaser agrees to provide the Vendor and its representatives, contractors and agents with access to the Strata Lot at all reasonable times on 24 hours' notice from the Vendor in order for the Vendor or its representatives, contractors or agents to rectify any outstanding Deficiencies, and the Purchaser will in no manner interfere with or impede any such person while he or she is carrying out such work.

- 13. Costs/Sales and Transfer Taxes.** The Purchaser will pay all taxes and costs in connection with the sale and purchase of the Strata Lot (including property transfer tax, any additional property transfer tax payable if the Purchaser is a foreign entity, a taxable trustee or both and any GST or any other federal or provincial sales, service, value added, transition or other tax required to be paid by the Purchaser in connection with the purchase and sale of the Strata Lot and the equipment and appliances included with the Strata Lot), other than the costs of the Vendor incurred in clearing title to the Strata Lot. Without limiting the generality of the foregoing, the Purchaser agrees that the Purchase Price does not include any applicable taxes (including GST or any other federal or provincial sales, service, value added, transition or other tax) that may be applicable to the sale of the Strata Lot (and any equipment and appliances included with it) hereunder whether levied against the Purchaser or the Vendor, all of which will be payable by the Purchaser on the Completion Date in addition to the Purchase Price.

If and to the extent required under Part IX of the *Excise Tax Act* (Canada), and subject to the foregoing, the Purchaser will remit to the Vendor on the Completion Date any GST that may be exigible under Part IX of the *Excise Tax Act* (Canada) in respect of the transaction contemplated herein, and the Vendor agrees that it will remit or otherwise account for such funds to Canada Revenue Agency ("**CRA**") in accordance with its obligations under Part IX of the *Excise Tax Act* (Canada) and the foregoing. Notwithstanding the foregoing, if the Purchaser is a corporation, trust or partnership which is registered for GST purposes and, on or before the Completion Date, the Purchaser provides the Vendor with a certificate as to the GST registered status of the Purchaser containing the Purchaser's GST registration number, the Purchaser will not be required to pay the GST to the Vendor but will be liable for, will self-assess and will remit same directly to CRA. The Purchaser will indemnify and save harmless the Vendor from and against any and all GST, penalties, costs and/or interest which may become payable by or assessed against the Vendor as a result of any failure by the Purchaser to comply with the foregoing and such indemnity will survive and not merge upon closing of the sale of the Strata Lot contemplated herein. The Purchaser acknowledges that the Vendor will have no obligation to adjust the Purchase Price to credit the Purchaser for any new housing rebate to which the Purchaser might be entitled.

14. Requirements under REDMA respecting Assignments.

- (a) In accordance with section 20.3(1) of REDMA and section 10.2(1) of the *Real Estate Development Marketing Regulation*, B.C. Reg. 505/2004 (the "**REDMA Regulation**"), the Vendor and the Purchaser agree as follows:
- (i) Without the Vendor's prior consent, any assignment of this Contract is prohibited.
 - (ii) An assignment under REDMA is a transfer of some or all of the rights, obligations and benefits under a purchase agreement made in respect of a strata lot in a development property, whether the transfer is made by the purchaser under the purchase agreement to another person or is a subsequent transfer.
 - (iii) Each proposed party to an assignment agreement must provide the Vendor with the information and records required under REDMA.
- (b) Pursuant to section 20.3(1) of REDMA and section 10.2(2) of the REDMA Regulation, the Vendor hereby gives notice to the Purchaser of the following:

INITIALS	

- (i) Before the Vendor consents to the assignment of this Contract, the Vendor will be required to collect information and records under REDMA from each proposed party to an assignment agreement, including personal information, respecting the following:
 - A. the party's identity;
 - B. the party's contact and business information; and
 - C. the terms of the assignment agreement.
- (ii) Information and records collected by the Vendor must be reported by the Vendor to the administrator designated under the *Property Transfer Tax Act*. The information and records may only be used or disclosed for tax purposes and other purposes authorized by section 20.5 of REDMA, which includes disclosure to the Canada Revenue Agency.
- (c) Without limiting anything set out in subsections 14(a) or 14(b), prior to the Vendor consenting to any assignment of this Contract, the Purchaser will cause each proposed party to an assignment agreement to give to the Vendor all information and records prescribed pursuant to section 20.3(2) of REDMA and/or section 10.3 of the REDMA Regulation (collectively, the "**Prescribed Information and Records**").
- (d) If the Vendor consents to any assignment of this Contract, the Purchaser will cause the parties to the assignment agreement to forthwith deliver to the Vendor a copy of the written and signed assignment agreement, and the Purchaser acknowledges and agrees that the Vendor may keep and use such copy of the assignment agreement for such purposes as may be required or permitted under REDMA or the REDMA Regulation.
- (e) The Purchaser acknowledges and agrees that the Vendor may, at any time and from time to time, (i) file the Prescribed Information and Records, as well as any other information and records regarding the Purchaser, any assignee or proposed assignee of this Contract and/or any assignment or proposed assignment of this Contract, with the administrator designated under the *Property Transfer Tax Act* and (ii) disclose the Prescribed Information and Records and such other information and records to such persons as may otherwise be required by law.
- (f) Forthwith upon the request of the Vendor, the Purchaser will provide, and will cause any assignee or proposed assignee of this Contract to provide, such other information and records as the Vendor may require or desire in connection with any assignment or proposed assignment of this Contract, including information regarding the Purchaser, the assignee or proposed assignee and/or the assignment or proposed assignment of this Contract. The Purchaser acknowledges that REDMA may be amended from time to time to modify the obligations and requirements, or to impose additional obligations and requirements, of the Vendor and/or the Purchaser with respect to assignments of purchase contracts, and the Purchaser covenants and agrees to comply with all such obligations and requirements and to cooperate with the Vendor and promptly comply with all requests of the Vendor in relation to such obligations and requirements.
- (g) For greater certainty, and notwithstanding anything else in this section 14 the notices, terms and conditions in this section 14 do not: (i) constitute consent by the Vendor to any assignment of this Contract; (ii) obligate the Vendor to consent to any assignment of this Contract; or (iii) derogate from, diminish, limit, amend or affect the Vendor's right to arbitrarily withhold its consent to any assignment of this Contract in the Vendor's sole and unfettered discretion pursuant to section 15 of this Contract. Accordingly, the Purchaser should not enter into this Contract with any expectation of, on reliance upon, the Purchaser's ability to assign this Contract in the future.

15. Assignment.

- (a) The Purchaser will not assign its interest in the Strata Lot or in this Contract without the prior written consent of the Vendor, which consent may be arbitrarily withheld in the Vendor's sole and unfettered discretion, and, without limiting the foregoing, the Vendor may withhold its consent in accordance with section 14 above. Unless the Vendor so consents, the Vendor is not required to convey the Strata Lot to anyone other than the Purchaser named in this Contract. Any consent permitted hereunder will be in the form of consent provided by the Vendor and will contain such terms and conditions as may be required by the Vendor in its sole discretion.

INITIALS	

- (b) The Purchaser will not, at any time before the Completion Date, advertise or solicit offers from the public with respect to the assignment of this Contract or the resale of the Strata Lot by the Purchaser without the prior written consent of the Vendor, which consent may be arbitrarily withheld in the Vendor's sole and unfettered discretion, and in particular, the Purchaser will not list the Strata lot or the Purchaser's interest in this Contract on any Multiple Listing Service (MLS). For greater certainty, if the Developer consents to the Purchaser advertising or soliciting offers from the public with respect to the assignment of this Contract or the resale of the Strata Lot by the Purchaser:
 - (i) such consent will be in the form of consent provided by the Vendor and will contain such terms and conditions as may be required by the Vendor in its sole discretion; and
 - (ii) such consent will not in any event be interpreted or construed as the Developer consenting to the assignment of the Contract by the Purchaser (which consent, for greater certainty, may be arbitrarily withheld by the Vendor in the Vendor's sole and unfettered discretion pursuant to subsection 15(a)).
- (c) As a condition for agreeing to an assignment of the Purchaser's interest in the Strata Lot or in this Contract and for any associated legal and administrative costs, the Vendor may, at its sole option, charge the Purchaser an administration fee equal to 2% of the aggregate of:
 - (i) an amount equal to any consideration paid by the assignee to the Purchaser in relation to the assignment plus applicable taxes thereon; and
 - (ii) the Purchase Price plus applicable taxes thereon.
- (d) Notwithstanding paragraph 15(c)(i) and 15(c)(ii), the Vendor will charge the Purchaser a flat fee of \$350.00 plus applicable taxes thereon if the assignee is the Purchaser's spouse, parent, child, grandparent, grandchild or sibling or a company controlled by the Purchaser. Following any assignment, the assignor will not be relieved of its obligations under this Contract but will continue to remain liable to perform all obligations of the Purchaser under this Contract.

16. Continuing Construction and Marketing. The Purchaser agrees that the Vendor may continue to carry out construction work on the Development after the completion of the purchase of the Strata Lot by the Purchaser, including, without limitation, construction of future phase(s), if any. The Purchaser acknowledges and accepts that such work may cause inconvenience to the use and enjoyment of the Strata Lot. The Purchaser will not impede or interfere with the Vendor's completion of construction of other strata lots, the common property or the Development. The Purchaser acknowledges that the Vendor may retain strata lots in the Development for use as sales and administrative offices and/or display suites for marketing purposes or otherwise to market the Development. The Purchaser agrees that for so long as the Vendor is the owner of any strata lots in the Development, the Vendor may carry out marketing, promotional and sales activities within the common property (including parking stalls and recreational facilities) of the Development or strata lots owned or leased by the Vendor, including, without limitation, maintaining display suites, other display areas, parking areas and signage (including signage on the exterior of the Development) and permitting public access to same for the purpose of marketing any unsold strata lots in the Development. In addition, the Vendor may conduct tours of the Development from time to time with prospective purchasers and hold events and other activities within the Development in connection with the marketing and sales activities for the Development.

17. Proxies. The Purchaser covenants and agree to, on or before the Completion Date and from time to time thereafter as the Developer may request, grant proxies to the Developer or to such other entities as the Developer may direct, in such form and containing such terms and conditions as the Developer may determine, in its sole discretion, permitting the Developer or such other entities to exercise the Purchaser's vote in the Strata Corporation, to, among other things, amend any strata plan(s) filed in the LTO in respect of the Development or any phase thereof or designate certain areas on such strata plans as limited common property for the exclusive use of one or more strata lots in the Development, and the Purchaser further covenants and agrees not to revoke such proxies. The Purchaser's covenants and obligations contained in this section 17 will survive and not merge upon the completion of the purchase and sale of the Strata Lot contemplated herein.

18. Successors and Assigns. This Contract will enure to the benefit of and be binding upon the parties hereto and their respective successors, permitted assigns, heirs, administrators and executors.

INITIALS	

19. **Governing Law.** This Purchaser's offer herein and the Contract which results from its acceptance will be exclusively governed by and construed in accordance with the laws of the Province of British Columbia and the parties agree to attorn to the exclusive jurisdiction of the courts of the Province of British Columbia.
20. **Contractual Rights.** This offer and the Contract which results from its acceptance creates contractual rights only and not any interest in land and the Purchaser will not be entitled to register this Contract or any interest arising under this Contract against the Strata Lot or the Lands. The Purchaser will acquire an interest in land upon completion of the purchase and sale contemplated herein.
21. **Personal Information.** The Purchaser hereby consents to the collection, use and disclosure of personal information contained in this Contract and otherwise collected by or on behalf of the Vendor and its agents, affiliates and service providers for the following purposes:
- (a) to complete the transaction contemplated by this Contract;
 - (b) to secure financing in respect of the construction of the Development;
 - (c) to invest the Deposit as provided for herein including providing personal information to the financial institution as required for reporting interest earned on the Deposit in accordance with applicable laws;
 - (d) to facilitate the entering into of a Deposit Protection Contract with respect to the Deposit and release of the Deposit in accordance therewith;
 - (e) to facilitate the completion and management of the Development including the transfer of management of the Development to a property manager;
 - (f) to market, sell, provide and inform the Purchaser of products and services of the Vendor and its affiliates and partners, including information about future projects;
 - (g) for any or all of the following purposes: to comply with any and all applicable laws and regulations (including, without limitation, the *Proceeds of Crime (Money Laundering) and Terrorist Financing Act (Canada)* and regulations, rules and policies thereunder or relating thereto and REDMA and all regulations thereto); to comply with applicable legal or regulatory obligations, including as part of a judicial proceeding; in response to a subpoena, warrant, court order or other legal process; or as part of an investigation or request, whether formal or informal, from law enforcement or a government official;
 - (h) to disclose such personal information to the Vendor' affiliates, agents, assignees, partners, business partners, contractors and suppliers, bankers, lawyers, accountants, insurers, warranty providers, utility providers, relevant governmental authorities or agencies (including the LTO and the CRA) and other advisors and consultants in furtherance of any of the foregoing purposes;
 - (i) to comply with the *Freedom of Information and Privacy Act* (British Columbia) and regulations, rules and policies thereunder or relating thereto;
 - (j) if the Strata Lot is listed on a Multiple Listing Service®, for the purpose of the compilation, retention and publication by the real estate board that operates the Multiple Listing Service® and other real estate boards of any statistics including historical Multiple Listing Service® data for use by persons authorized to use the Multiple Listing Service® of that real estate board and other real estate boards;
 - (k) for enforcing codes of professional conduct and ethics for members of real estate boards;
 - (l) for the purpose (and to the recipients) described in the brochure published by the British Columbia Real Estate Association entitled Working with A Realtor®; and
 - (m) to comply with the Vendor's legal reporting requirements in respect of assignments and proposed assignments.

The Purchaser covenants and agrees to provide, and cause any third parties to provide, to the Vendor, the Vendor's agents and the Vendor's Solicitors, promptly upon request, any additional personal or other information not contained

INITIALS	

herein that is required in order to comply with the *Proceeds of Crime (Money Laundering) and Terrorist Financing Act* (Canada) and regulations, rules and policies thereunder or relating thereto, and the Purchaser acknowledges that the foregoing consent applies to any such personal information.

- 22. **Vendor's Right to Terminate.** The Vendor may in its sole discretion terminate this Contract if the Vendor has reasonable grounds to suspect that any part of the transaction contemplated by this Contract is related to the commission or attempted commission of a "money laundering offence" or a "terrorist activity financing offence", as defined in the *Proceeds of Crime (Money Laundering) and Terrorist Financing Act* (Canada) and regulations under that Act, as amended from time to time, in which event the portion of the Deposit that has been paid will be returned to the Purchaser and the Purchaser will have no further claims against the Vendor.

- 23. **Notices and Tender.** Any notice to be given to the Purchaser hereunder will be sufficiently given (a) if deposited in any postal receptacle in Canada addressed to the Purchaser at the Purchaser's address or the Purchaser's Solicitors at their offices and sent by regular mail, postage prepaid, or (b) if delivered by hand or if transmitted by facsimile or e-mail to the Purchaser's Solicitors at their office or to the Purchaser. Such notice will be deemed to have been received if so delivered or transmitted, when delivered or transmitted and if mailed, on the second Business Day after such mailing. The address, fax number (if any) and e-mail address (if any) for the Purchaser will be as set out above or such other address, fax number or e-mail address of which the Purchaser has last notified the Vendor in writing. Any documents to be tendered on the Purchaser may be tendered on the Purchaser or the Purchaser's Solicitors. Any notice to be given to the Vendor may be given to the Vendor or the Vendor's Solicitors in the same manner, and will be deemed to have been received, as provided for in the preceding provisions of this section, all other matters remaining the same except as altered where necessary. Any documents or money to be tendered on the Vendor or the Vendor's Solicitors will be tendered by way of certified funds or bank draft and will be delivered at the Purchaser's expense to the Vendor or the Vendor's Solicitors.

- 24. **Purchaser Comprising More Than One Party.** If the Purchaser consists of more than one party, then the obligations of the Purchaser hereunder will be the joint and several obligations of each party comprising the Purchaser and any notice given to one of such parties will be deemed to have been given at the same time to both or all of such parties comprising the Purchaser.

- 25. **Change of Address.** The Purchaser covenants and agrees to promptly notify the Vendor in writing of any change in the Purchaser's address, e-mail address, phone number and/or fax number.

- 26. **Disclosure Statement.**
 - (a) In this Contract:
 - (i) "Initial Disclosure Statement" means the initial disclosure statement dated December 19, 2022, filed with the Superintendent of Real Estate with respect to the Development;
 - (ii) "Disclosure Statement" means, collectively, the Initial Disclosure Statement together with and as amended by the amendment to disclosure statement dated August 30, 2023 and any and all amendments to disclosure statement filed from time to time with respect to the Initial Disclosure Statement; and
 - (iii) "Consolidated Disclosure Statement" means the consolidated disclosure statement dated August 30, 2023 filed with the Superintendent of Real Estate with respect to the Development.
 - (b) The Purchaser acknowledges and confirms that, before entering into this Contract, he/she/it has received a copy of, and has been given a reasonable opportunity to read, the Consolidated Disclosure Statement and any subsequent amendment(s) to disclosure statement if any, filed on or before the date hereof. The Purchaser acknowledges that the Consolidated Disclosure Statement contains the contents of the Disclosure Statement as of the date of the Consolidated Disclosure Statement (including the Initial Disclosure Statement and all amendments(s) to disclosure statement filed from time to time up to and including the date of the Consolidated Disclosure Statement).
 - (c) The Vendor acknowledges its obligation to deliver to the Purchaser an amendment (the "Building Permit Amendment") to the Disclosure Statement setting out particulars of the issued building permit in respect of the strata lots in Phase 1 of the Development and an amendment (the "Financing Amendment") to the Disclosure Statement setting out particulars of a satisfactory financing commitment in respect of the strata

INITIALS	

lots in Phase 1 of the Development, as contemplated in the Disclosure Statement. The Vendor and Purchaser agree that:

- (i) the Purchaser may cancel this Contract for a period of seven days after receipt of the Building Permit Amendment if the layout or size of the Strata Lot, the construction of a major common facility, including a recreation centre or clubhouse, or the general layout of the Development, is materially changed by the issuance of the building permit;
 - (ii) if the Building Permit Amendment is not received by the Purchaser within 12 months after the Initial Disclosure Statement was filed with the Superintendent of Real Estate (the “**Superintendent**”), the Purchaser may at his/her/its/their option cancel this Contract at any time after the end of the 12 month period until the Building Permit Amendment is received by the Purchaser, at which time the Purchaser may cancel this Contract for a period of seven days after receipt of the Building Permit Amendment only if the layout or size of the Strata Lot, the construction of a major common facility, including a recreation centre or clubhouse, or the general layout of the Development, is materially changed by the issuance of the building permit;
 - (iii) if the Financing Amendment is not received by the Purchaser within 12 months after the Initial Disclosure Statement was filed with the Superintendent, the Purchaser may at his/her/its/their option cancel this Contract at any time after the end of the 12-month period until the Financing Amendment is received by the Purchaser;
 - (iv) the amount of the Deposit to be paid by the Purchaser prior to receiving the Building Permit Amendment and the Financing Amendment will be no more than 10% of the Purchase Price; and
 - (v) all deposits paid by the Purchaser, including interest earned if applicable, will be returned promptly to the Purchaser upon notice of cancellation from the Purchaser pursuant to this section 26.
- (d) The Purchaser will, from time to time, forthwith upon receipt from the Vendor of a copy of any amendment to disclosure statement filed in respect of the Disclosure Statement, execute and deliver to the Vendor a receipt, in a form to be provided by the Vendor, pursuant to which the Purchaser confirms that it received a copy of such amendment to disclosure statement.

27. **Counterparts and Delivery by Electronic Transmission.** This Contract and any addendum hereto may be executed in any number of counterparts, each of which will be deemed to be an original and all of which, taken together, will be deemed to constitute one and the same instrument. Delivery of an executed copy of this Contract and any addendum hereto by any party by electronic transmission will be as effective as personal delivery of an originally executed copy of this Contract by such party.
28. **Business Day.** In this Contract, “**Business Day**” means any day that is not one of the following: a Saturday, Sunday, statutory holiday in British Columbia, Boxing Day, Easter Monday, the National Day for Truth and Reconciliation or any other day on which the Land Title Office is not open for business.
29. **Phase.** In this Contract, “**Phase 1**” and “**Phase 2**” will have the meaning given to those terms in the Disclosure Statement.

INITIALS	

EXHIBIT J
PARKING AND STORAGE LEASE

See attached.

**THE SELKIRKS AND MONASHEES AT MACKENZIE VILLAGE
PARKING AND STORAGE LEASE**

THIS AGREEMENT made as of December 19, 2022

BETWEEN:

0929468 B.C. LTD.
Suite 900 - 900 West Hastings Street
Vancouver B.C.
V6C 1E5

(the "**Landlord**")

AND:

MACKENZIE PLAZA PARKING CO. LTD.
Suite 2800 – 650 West Georgia Street
Vancouver, B.C.
V6B 4N7

(the "**Tenant**")

WITNESSES THAT WHEREAS:

- A. The Landlord is the registered and beneficial owner of certain lands and premises located in Revelstoke, British Columbia, and currently legally described as:

Parcel Identifier: 030-260-833
Lot 2
Section 23
Township 23
Range 2 West of the 6th Meridian
Kootenay District
Plan EPP69441 Except Plan EPP98511

(the "**Parent Parcel**");

- B. After entering into this Lease and prior to the completion of the Development (as defined below), the Landlord proposes to subdivide the Parent Parcel by the registration of a subdivision plan (the "**Subdivision Plan**") in respect of the Parent Parcel. The deposit of the Subdivision Plan in the Land Title Office will create a new legal parcel (the "**Lands**") consisting of a portion of the Parent Parcel.
- C. A two phase ("**Phase 1**" and "**Phase 2**", respectively, individually, a "**Phase**" and collectively, the "**Phases**") residential strata development known as "The Selkirks and Monashees at Mackenzie Village" (the "**Development**") will be constructed and developed upon the Lands by the Landlord;
- D. After entering into this Lease and completing construction of Phase 1 of the Development, the Landlord proposes to subdivide the Lands by the registration of a phased strata plan (the "**Strata Plan**") in respect of the Lands pursuant to the *Strata Property Act* (British Columbia) (the "**SPA**");

- E. The strata lots (the “**Strata Lots**”) in the Development will be created by the deposit of the Strata Plan for registration in the Land Title Office;
- F. The strata corporation (the “**Strata Corporation**”) for the Development will be formed upon the deposit of the Phase 1 Strata Plan in the Land Title Office;
- G. As the Strata Plan with respect to each Phase is deposited for registration, the portion of the Parking Facility (as defined below) located within each such Phase will be designated as common property of the Strata Corporation;
- H. As part of the Development, the Landlord will be constructing a concrete underground parking facility (the “**Parking Facility**”), portions of which will be located in each of Phase 1 and Phase 2;
- I. The Landlord has agreed to lease to the Tenant:
 - (a) all of those parking stalls (the “**Stalls**”) denoted as “Residential Parking Stalls” on the Parking/Storage Plan (as defined below) and the associated drive aisles which are to be constructed within, and upon, the Parking Facility; and
 - (b) all of the storage lockers (the “**Lockers**”) located within the storage rooms to be constructed on the first floor of the buildings in the Development,which are generally shown outlined in heavy black line on the parking/storage plan (the “**Parking/Storage Plan**”), a reduced copy of which is attached hereto as Schedule A, all on the terms and conditions set out in this Lease and with the right of the Tenant to grant partial assignments of this Lease pertaining to particular Stalls and Lockers; and
- J. Each of the parties to this Lease agrees that title to the common property of the Strata Corporation will be subject to and encumbered by this Lease.

NOW THEREFORE in consideration of these premises and the sum of \$10.00 of lawful money of Canada now paid by the Tenant to the Landlord, the receipt and sufficiency of which are hereby acknowledged by the Landlord, and in consideration of the mutual promises and agreements set forth in this Lease, the parties agree each with the other as follows:

ARTICLE 1 - GRANT AND TERM

1.1 Grant

The Landlord hereby leases to the Tenant for the Term (as defined in section 1.2) all of the Stalls and Lockers on the terms and conditions set out in this Lease.

1.2 Term

The term (the “**Term**”) of this Lease will commence on the date first written above (the “**Commencement Date**”) and will terminate on the earlier of: (i) the date that the Strata Corporation is dissolved; and (ii) the date which is 999 years after the Commencement Date.

For the purposes of this provision, the amalgamation of the Strata Corporation with another strata corporation will not be considered a dissolution of the Strata Corporation.

1.3 Rent

The parties to this Lease acknowledge that, subject to section 1.5, the sum of \$10.00 now paid by the Tenant to the Landlord will be the only payment required to be paid to the Landlord by either the Tenant or any assignee of a partial assignment under this Lease for the use and enjoyment of a Stall and/or a Locker.

1.4 Licence

The Landlord agrees that the Tenant and any assignee (including an assignee of a partial assignment under this Lease in respect of any Stall or Locker) may at all times, in common with the Landlord and all other persons now or hereafter having the express or implied permission of the Landlord or having a similar right, enter upon and pass over any part of the Lands designated as drive aisles, driveways, ramps, roadways, stairways, elevators or walkways for the purpose of obtaining access to or egress from the Parking Facility or a particular Stall or Locker, provided that the operation of vehicles will be restricted to drive aisles, driveways, ramps and roadways and access by foot will be restricted to pedestrian walkways, stairways and elevators. The Landlord will at all times provide the Tenant, in its capacity as the tenant under this Lease and any assignee (including an assignee of a partial assignment under this Lease in respect of any Stall or Locker), with means of access to any security devices as necessary to enable the Tenant and subsequent assignees to use and enjoy the Stall or Locker to which the Tenant or subsequent assignees are entitled.

1.5 Acknowledgement

Notwithstanding any other provision of this Lease:

- (a) 0929468 B.C. Ltd. (the "**Original Landlord**") may enter into agreements with the purchasers of Strata Lots within the Development whereby the Original Landlord will agree to provide one or more Stalls and/or Lockers to such purchasers in exchange for the payment of certain amounts agreed to by the Original Landlord and such purchasers, and that such amounts will be paid to, and be the absolute property of, the Original Landlord; and
- (b) the Tenant will, as and when directed to do so by the Original Landlord, grant partial assignments of this Lease, in respect of such Stalls and/or Lockers as may be designated by the Original Landlord, to the purchasers of Strata Lots within the Development in exchange for the payment of certain amounts agreed to by the Original Landlord and such purchasers, and that such amounts will be paid to, and be the absolute property of, the Original Landlord.

This provision will not in any manner be construed or interpreted as giving the Strata Corporation, as assignee of the Landlord pursuant to an assignment of this Lease by the Landlord and an assumption of this Lease by the Strata Corporation, the right to cause or direct the Tenant to grant partial assignments in respect of any Stall and/or Locker, and, for greater certainty, the Strata Corporation, cannot so cause or direct the Tenant to grant any such assignments.

**ARTICLE 2 -
SUBDIVISION BY STRATA PLAN**

2.1 Strata Plan/Assumption by Strata Corporation

This Lease and the covenants and obligations of the Landlord under this Lease run with and bind the Lands and, upon the subdivision of the Lands by means of the Strata Plan, such covenants and obligations will continue to run with and bind each subdivided parcel forming part of the Development which contains a portion of the Parking Facility.

Upon the deposit of the Phase 1 Strata Plan in the Land Title Office, the Landlord will cause the Strata Corporation to enter into an agreement, in a form reasonably required by the Landlord, pursuant to which the Landlord will assign to the Strata Corporation all of its right, title and benefit hereunder, and the Strata Corporation will assume all of the covenants and obligations of the Landlord under this Lease, as the representative of the owners of the strata lots within the Development, provided however that the assignment and assumption will be suspended insofar as this Lease applies to Stalls and Lockers within Phase 2 until, and conditional upon, the deposit of the Phase 2 Strata Plan.

The assumption agreement will also provide that, upon execution thereof, the Landlord will be absolutely released from any obligations or liabilities hereunder and no longer entitled to the benefit of any rights hereunder, provided however that such release and cessation of rights will not be effective insofar as this Lease applies to Stalls and Lockers within Phase 2 until, and conditional upon, the deposit of the Phase 2 Strata Plan.

For greater certainty, and notwithstanding the foregoing, the Original Landlord will remain entitled to its rights under section 1.5 at all times and such rights will not be assigned to the Strata Corporation at any time.

2.2 Common Property

This Lease is intended to apply only to a portion of the common property (including limited common property) which will be created upon the deposit for registration of the Strata Plan and not at any time to burden the title to any individual Strata Lot. Both of the parties to this Lease agree that title to the common property of the Strata Corporation will be subject to and encumbered by this Lease.

**ARTICLE 3 -
MAINTENANCE AND ENCUMBRANCES**

3.1 Maintenance

The Landlord and the Tenant acknowledge and agree that, until the deposit for registration of the Phase 1 Strata Plan, the Landlord will be solely responsible, subject to the terms of this Lease, for the control, management and administration of the Stalls and Lockers but thereafter, pursuant to section 2.1 of this Lease, the Strata Corporation will, subject always to the Landlord's rights under section 1.5 of this Lease, assume full responsibility for the control, management, administration, maintenance and repair of the Stalls and Lockers as common property and/or limited common property in accordance with the provisions of the SPA and the bylaws of the Strata Corporation, as the case may be, and may pass bylaws or make rules and regulations with respect to the Stalls and Lockers as long as such bylaws, rules or regulations do not materially interfere with the rights of the Tenant or any subsequent assignee under this

Lease (including the right of the Tenant to partially assign this Lease as it relates to particular Stalls and Lockers) and apply equally to the Tenant and all assignees hereunder.

Notwithstanding the foregoing, in accordance with section 2.1 of this Lease, the Landlord and the Tenant agree that the assumption by the Strata Corporation of responsibility for the control, management, administration, maintenance and repair of the Stalls and Lockers located in Phase 2 is postponed and conditional until such time as the Phase 2 Strata Plan is deposited at the Land Title Office.

3.2 Alterations

The Tenant and its successors and permitted assigns are not entitled to alter, or to perform any repairs of any sort whatsoever to, the Stalls or the Lockers. Any such alterations or repairs with respect to the Stalls or the Lockers located in each Phase of the Development are the sole responsibility of the Landlord prior to the registration of the Strata Plan for such Phase in the Land Title Office, and thereafter the sole responsibility of the Strata Corporation, it being acknowledged and agreed that the Strata Corporation, not the Landlord, will be responsible for alterations or repairs in respect of the Stalls and Lockers located in a Phase immediately upon the deposit for registration of the Strata Plan for such Phase.

3.3 Subordination

The Tenant agrees to subordinate its interest pursuant to this Lease to any financial encumbrance registered by the Landlord against title to the Lands.

3.4 No Right to Encumber

Neither the Tenant nor any subsequent assignee of any interest of the Tenant under this Lease will mortgage, charge, pledge or otherwise grant their interest in any Stall or Locker as security to any person.

ARTICLE 4 - ASSIGNMENT

4.1 Partial Assignments

The Tenant may partially assign this Lease and its rights under this Lease pertaining to one or more particular Stalls and/or Lockers to: (i) a purchaser or owner of a Strata Lot; (ii) the Tenant if the assignor is a person other than the Tenant; or (iii) the Strata Corporation (each, a **"Permitted Assignee"**). Subject always to section 1.5, any such assignment will be for such consideration as the assignor or assignee may determine, which consideration may be retained by the assignor for its own benefit. Any partial assignment by the Tenant, or by any subsequent assignee, of this Lease and its rights under this Lease pertaining to a particular Stall or Locker:

- (a) will be absolute, and the assignee and its guests, lessees, successors and permitted assigns will be entitled to the use and enjoyment of the Stall and/or Locker so assigned for the balance of the Term;
- (b) will be an assignment of rights to which an assignee will only be entitled for so long as such assignee owns a Strata Lot, unless the assignment is to the Tenant where the assignor is a person other than the Tenant, or to the Strata Corporation;

- (c) may only be assigned to a Permitted Assignee; and
- (d) will not be effective until written notice of such assignment (together with a copy of such assignment if available) is delivered by the assignee to the Strata Corporation, subject to section 4.2 of this Lease.

4.2 Automatic Assignment

If a holder of an interest in a Stall and/or Locker transfers all of his or her interest in a Strata Lot to which such Stall and/or Locker is at such time appurtenant as shown on the register maintained under section 4.9 without concurrently executing an assignment of such Stall and/or Locker to another owner or purchaser of a Strata Lot, then the interest of such holder in such Stall and/or Locker will be deemed to have been automatically assigned to and assumed by the purchaser of such Strata Lot without execution of a partial assignment of this Lease with respect to such Stall and/or Locker or delivery of notice of such partial assignment to the Strata Corporation.

Notwithstanding the foregoing, this section 4.2 and the automatic assignment contemplated herein will not apply where the holder of the interest in the applicable Stall or Locker is a Developer Company (as defined in section 4.10).

4.3 Exchanges and Transfers

- (a) Exchanges. A holder of an interest (the “**First Owner**” in this subsection) in a Stall and/or Locker (the “**First Stall/Locker**” in this subsection) may exchange his or her interest in the First Stall/Locker with the holder (including the Tenant) of an interest (the “**Second Owner**” in this subsection) in a different Stall/Locker (the “**Second Stall/Locker**” in this subsection) for such consideration as the First Owner and the Second Owner may agree. Such an exchange will be accomplished by the First Owner partially assigning this Lease to the Second Owner in respect of the First Stall/Locker, and the Second Owner partially assigning this Lease to the First Owner in respect of the Second Stall/Locker. The First Owner and the Second Owner will each execute a partial assignment of this Lease in favour of the other substantially in the form attached hereto as Schedule B. The exchange will be on the terms set out in subsections 4.1(a) to (c) and will not be effective until written notice of each assignment (together with a copy of each assignment) is delivered to the Strata Corporation.
- (b) Transfers. A holder of an interest (the “**First Owner**” in this subsection) in a Stall and/or Locker may transfer his or her interest in such Stall and/or Locker to a Permitted Assignee (the “**Second Owner**” in this subsection) for such consideration as the First Owner may in his or her discretion determine. Such a transfer will be accomplished by the First Owner partially assigning this Lease to the Second Owner and, in connection therewith, the First Owner will execute a partial assignment in favour of the Second Owner substantially in the form attached hereto as Schedule B. The transfer will be on the terms set out in subsections 4.1(a) to (d).

4.4 EV Stall Reallocation

- (a) In this section 4.4: (i) “**Qualified Owner**” means an owner of a Strata Lot who resides in such Strata Lot and who has, or whose spouse, dependent child or

tenant resides in such Strata Lot and has, an electric vehicle; and (ii) “**Non-Qualified Owner**” means an owner of a Strata Lot who is not a Qualified Owner.

- (b) Certain of the Stalls (the “**EV Stalls**”) are configured with an operational electric outlet and an electric service connection conduit with pull string to enable future activation of an electric vehicle plug-in charger (an “**EV Plug-in Charger**”) for electric vehicle charging. If a Qualified Owner is the holder of an interest in a Stall (a “**Non-EV Stall**”) that is not an EV Stall, then the Qualified Owner may make a written request that the Strata Corporation exchange the Qualified Owner’s Non-EV Stall for an EV Stall. Upon receipt by the Strata Corporation of a written request for such an exchange from a Qualified Owner, the Strata Corporation will require, within sixty days of receipt of the written request from the Qualified Owner, that a Non-Qualified Owner who is the holder of an interest in an EV Stall (if any and to be selected by the Strata Corporation in its sole discretion if there is more than one such Non-Qualified Owner) exchange his or her interest in the EV Stall with the Qualified Owner for his or her interest in the Non-EV Stall for no consideration. Such an exchange will be accomplished by the Non-Qualified Owner partially assigning this Lease to the Qualified Owner in respect of the EV Stall, and the Qualified Owner partially assigning this Lease to the Non-Qualified Owner in respect of the Non-EV Stall. The Non-Qualified Owner and the Qualified Owner will each execute a partial assignment of this Lease in favour of the other substantially in the form attached hereto as Schedule B, and the Strata Corporation is hereby granted a power of attorney to execute such partial assignment on behalf of the Non-Qualified Owner to effect such transfer. An exchange pursuant to this section 4.4 will be on the terms set out in subsections 4.1(a) to (d).
- (c) For clarity, a Stall is deemed to be an EV Stall for the purposes of this Lease if: (i) an electrical outlet is within such Stall or immediately adjacent thereto; (ii) it is labelled on the Parking/Storage Plan as being an EV Stall; or (iii) it is otherwise designated by the developer of the Development as being an EV Stall.
- (d) Notwithstanding anything to the contrary contained in this Lease, this section 4.4 and the exchange mechanism contained herein will not apply to any EV Stall held by a Developer Company.

4.5 Disabled Stalls Re-Allocation

- (a) In this section 4.5: (i) “**Qualified Owner**” means an owner of a Strata Lot within the Development who resides in such Strata Lot and who has been issued, or in the case of an owner who is a natural person, whose spouse or dependent child resides in such Strata Lot and has been issued, or whose (whether or not such owner is a natural person) tenant resides in such Strata Lot and has been issued, a valid parking permit for people with disabilities from the Social Planning and Research Council of British Columbia (or a disabled person’s parking permit otherwise issued in accordance with the *Motor Vehicle Act* (British Columbia); and (ii) “**Non-Qualified Owner**” means an owner of a Strata Lot who is not a Qualified Owner.
- (b) Approximately ten (10) of the Stalls (the “**Disabled Stalls**”) will be designed and constructed in accordance with the applicable bylaws of the City of Revelstoke (the “**City**”) to accommodate vehicles driven by individuals who have a loss, or a

reduction, of functional ability and activity (including a person in a wheelchair and a person with a sensory disability).

- (c) If a Qualified Owner is the holder of an interest in a Stall (a **“Non-Disabled Stall”**) that is not a Disabled Stall, then the Qualified Owner may make a written request that the Strata Corporation exchange the Qualified Owner’s Non-Disabled Stall for a Disabled Stall. Upon receipt by the Strata Corporation of a written request for such an exchange from a Qualified Owner, the Strata Corporation will require that a Non-Qualified Owner who is the holder of an interest in a Disabled Stall (to the extent that any is available and to be selected by the Strata Corporation, in each case, at the sole discretion of the Strata Corporation, if there is more than one such Non-Qualified Owner) exchange his or her interest in the Disabled Stall with the Qualified Owner for his or her interest in the Non-Disabled Stall for no consideration. Such an exchange will be accomplished by the Non-Qualified Owner partially assigning this Lease to the Qualified Owner in respect of the Disabled Stall, and the Qualified Owner partially assigning this Lease to the Non-Qualified Owner in respect of the Non-Disabled Stall. The Non-Qualified Owner and the Qualified Owner will each execute a partial assignment of this Lease in favour of the other substantially in the form attached hereto as Schedule B, and the Strata Corporation is hereby granted a power of attorney to execute such partial assignment on behalf of the Non-Qualified Owner to effect such transfer. Any exchange pursuant to this section 4.5 will be on the terms set out in subsections 4.1(a) to (d), provided however that, if the Strata Corporation executes a partial assignment on behalf of the Non-Qualified Owner to effect such transfer pursuant to the foregoing power of attorney, such transfer will be effective upon execution of the partial assignment by the Strata Corporation and the Qualified Owner and the Strata Corporation, as the case may be, may make and retain a copy of such partial assignment.
- (d) For clarity, a Stall is deemed to be a Disabled Stall for the purposes of this Lease if: (i) it is labelled on the Parking/Storage Plan as being a Disabled Stall; or (ii) it is otherwise designated by the developer of the Development as being a Disabled Stalls.
- (e) Notwithstanding anything to the contrary contained in this Lease, this section 4.5 and the exchange mechanisms contained herein will not apply to any Disabled Stall held by a Developer Company.

4.6 Consents

The consent of the Strata Corporation will not be required for any partial assignment of this Lease. The Strata Corporation will not interfere with or attempt to interrupt or terminate the rights of an assignee under any such assignment except as expressly agreed by such assignee.

4.7 Form of Partial Assignments

Subject to section 4.2, all partial assignments of this Lease will be substantially in the form attached hereto as Schedule B.

4.8 Release of Assignors

Upon the partial assignment (including an automatic assignment pursuant to section 4.2) of this Lease pertaining to a particular Stall and/or Locker, the Tenant and any subsequent assignor of an interest in such Stall and/or Locker will be automatically and absolutely released from any obligations or liabilities under this Lease pertaining to such Stall and/or Locker.

4.9 Register of Partial Assignments

The Landlord and, upon assumption by the Strata Corporation of this Lease, the Strata Corporation will maintain a register of all Stalls and Lockers and will record on such register each partial assignment of this Lease, indicating:

- (a) the number of the Stall and/or Locker assigned;
- (b) the date of assignment;
- (c) the name and address of the assignee; and
- (d) the number of the Strata Lot owned by the assignee to which such Stall and/or Locker is at the time appurtenant, unless the assignee is the Strata Corporation or the Tenant, in which event the Stall and/or Locker need not be appurtenant to a Strata Lot.

Upon request by any owner or prospective purchaser of a Strata Lot, the Strata Corporation will provide a certificate, within seven days after receipt of such request, certifying the name and address of the owner to whom a particular Stall and/or Locker is assigned and the number of the Strata Lot to which such Stall and/or Locker is at the time appurtenant. The Strata Corporation may require a fee of not more than \$10.00, or a greater amount reasonably prescribed by the bylaws of the Strata Corporation, from the person requesting such certificate. Upon the Strata Corporation becoming aware of a partial assignment pertaining to a particular Stall and/or Locker under section 4.1, 4.2, 4.3, 4.4 or 4.5, the Strata Corporation will amend the register accordingly.

4.10 Assignment by the Tenant

Upon the deposit of the Strata Plan in the Land Title Office and the assumption of the Landlord's interest in this lease by the Strata Corporation, the Tenant may assign some or all of its rights under this lease to 0929468 (as defined below), as tenant, without the consent of the Strata Corporation provided that 0929468 assumes, in writing, the covenants and obligations of the Tenant under this Lease and, upon execution thereof, the Tenant will be absolutely released from any obligations or liabilities hereunder and no longer entitled to the benefit of any rights hereunder and 0929468 will be entitled to enjoy and exercise all of the rights of the Tenant hereunder.

In this Lease: (i) "**0929468**" means 0929468 B.C. Ltd.; (ii) "**ParkingCo**" means Mackenzie Plaza Parking Co. Ltd.; and (iii) "**Developer Company**" means 0929468 or ParkingCo.

ARTICLE 5 - MISCELLANEOUS

5.1 No Registration

No partial assignment hereof will be registered by any assignee in any land title office.

5.2 Severability

If any provision or a portion of a provision of this Lease is found to be illegal or unenforceable, then such provision or portion will be severed from this Lease and this Lease will be deemed to be so amended, and this Lease will continue in full force and effect subject only to such amendment.

5.3 Definitions

Any term defined in the recitals to this Lease will have the same meaning throughout this Lease unless otherwise redefined.

5.4 Meaning of "Person"

In this Lease, "person" means an individual, corporation, body corporate or unincorporated organization or any trustee, executor, administrator or other legal representative.

5.5 Form of Agreement

Each of the parties hereto agrees to amend the form of this Lease to meet the requirements of the Registrar of the Land Title Office or of any governmental or public authority or as otherwise necessary to confirm unto the parties the rights granted in this Lease.

5.6 Enurement

This Lease will enure to the benefit of and be binding upon each of the parties hereto and their respective successors and permitted assigns.

[Remainder of page left intentionally blank. Signature page follows.]

IN WITNESS WHEREOF the parties hereto have executed this Lease by their respective authorized officers.

By the Landlord:

0929468 B.C. LTD.

By:

Authorized Signatory

By:

Authorized Signatory

By the Tenant:

MACKENZIE PLAZA PARKING CO. LTD.

By:

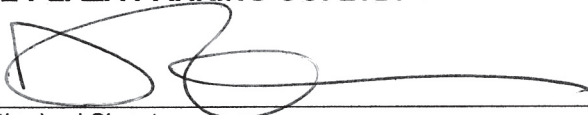
Authorized Signatory

By:

Authorized Signatory

SCHEDULE A

PARKING/ STORAGE LOCKER PLAN

The attached sketch plan has been prepared based on architectural drawings and a preliminary strata plan for the Development and generally identifies the areas within which the Stalls and Lockers will be located. The Tenant will, and is hereby authorized to, replace the attached sketch plan with a sketch plan or explanatory plan showing the actual location of the Stalls and Lockers upon completion of construction and delineation of the same.

SKETCH PLAN OF PARKING STALLS - THE SELKIRKS AND MONASHEES AT MACKENZIE VILLAGE - PHASE 1 (THE SELKIRKS)



The intended plot size of this plan is 432mm in width by 280mm in height (B size) when plotted at a scale of 1:1250.

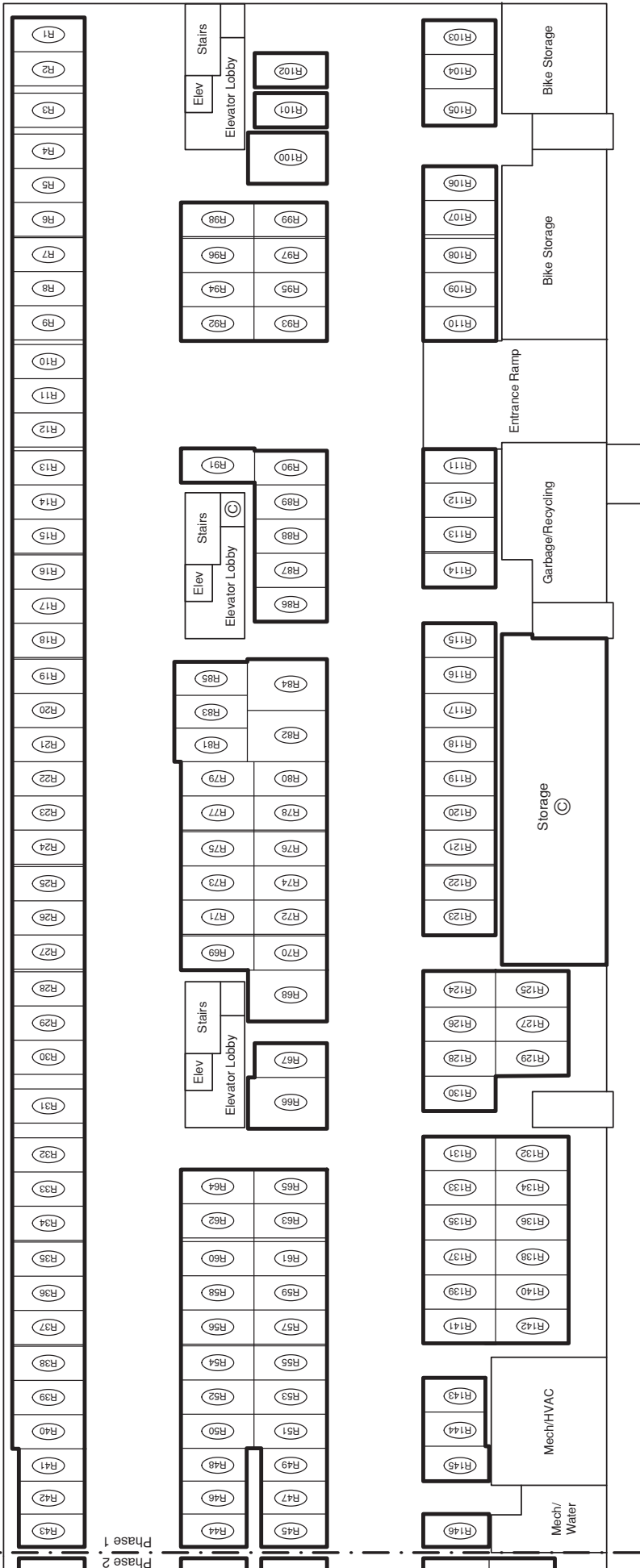

LEGEND

- denotes Residential Parking Stall
- denotes Common Property



202 - 1475 Ellis Street
Kelowna, BC

PROJECT REF./DRAWING No.
22-03760-001-SK03-R2-PA RKING

December 19, 2022

SKETCH PLAN OF PARKING STALLS - THE SELKIRKS AND MONASHEES AT MACKENZIE VILLAGE - PHASE 2 (THE MONASHEES)



The intended plot size of this plan is 432mm in width by 280mm in height (B size) when plotted at a scale of 1:1250.

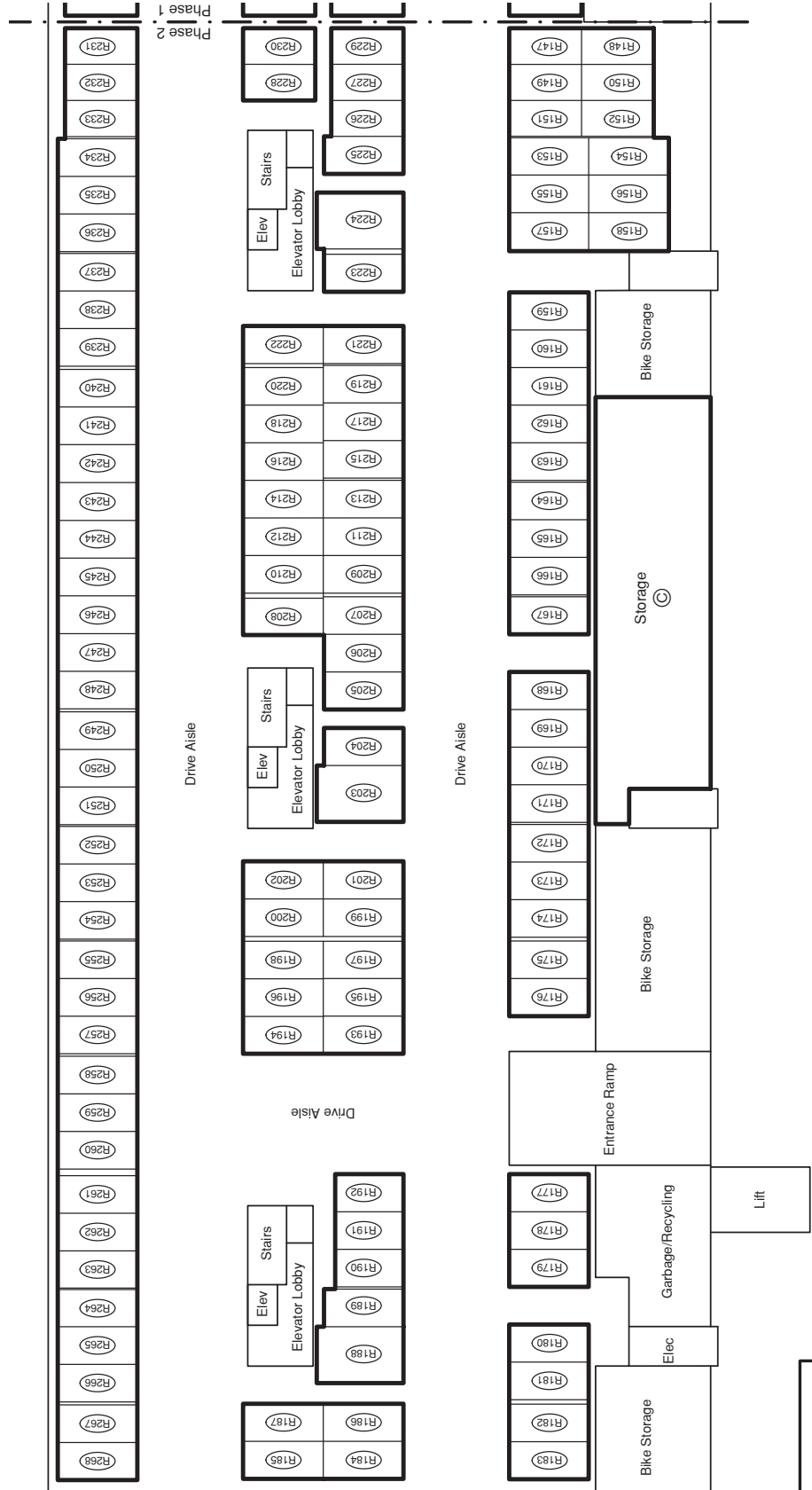

LEGEND
 R denotes Residential Parking Stall
 C denotes Common Property



202 - 1475 Ellis Street
 Kelowna, BC

PROJECT REF./DRAWING No.
 22-03760-001-SK03-R2-PA RKING

December 19, 2022

SCHEDULE B

THE SELKIRKS AND MONASHEES AT MACKENZIE VILLAGE PARKING AND STORAGE LEASE ASSIGNMENT

BETWEEN:

•

(the “Assignor”)

AND:

•

(the “Assignee”)

RE: Parking stall(s) No(s). _____ (the “**Parking Stall(s)**”) and/or EV Stall(s) No.(s)_____ and/or Disabled Stall No.(s) _____ (the EV Stall(s), the Disabled Stall and the Parking Stall(s) are collectively referred to herein as the “**Stall(s)**”) and/or storage locker(s) No(s). _____ (the “**Locker(s)**”) as shown on the plan attached to the parking and storage lease (the “**Lease**”) dated • made between 0929468 B.C. Ltd., as lessor, and Mackenzie Plaza Parking Co. Ltd., as lessee, as subsequently assigned

WHEREAS the Assignor is the lessee of the Stall(s) and/or Locker(s) and the Assignee is one of the following: (a) The Owners, Strata Plan EPS• (the “**Strata Corporation**”); (b) 0929468 B.C. Ltd. or Mackenzie Plaza Parking Co. Ltd. (as the case may be, the “**Tenant**”); or (c) the registered owner or purchaser of Strata Lot _____ (Suite No. _____) (the “**Strata Lot**”) in the Development (as defined in the Lease).

In consideration of the covenants and agreements set forth in this Assignment, the parties agree with each other as follows:

1. Assignment

The Assignor hereby assigns to the Assignee its partial interest in the Lease pertaining to the exclusive right to lease the Stall(s) and/or the Locker(s), and including the right of access set out in section 1.4 of the Lease, for the balance of the Term (as defined in the Lease). Subject to section 4.2 of the Lease, this Assignment will not be effective until the Assignee has given a copy of this Assignment to the Strata Corporation.

2. **Assignment Contingent Upon Strata Lot Ownership**

Unless the Assignee is the Strata Corporation or the Tenant, the Assignee, its successors, permitted assigns, heirs, executors or administrators will only be entitled to the rights with respect to the Stall(s) and/or the Locker(s) for as long as the Assignee owns the Strata Lot and, accordingly, following the sale of such Strata Lot by the Assignee, the Assignee and its successors, permitted assigns, heirs, executors and administrators will no longer have any right to use, sell, rent or assign the Stall or Locker.

3. Compliance

The Assignee agrees to use and deal with the Stall(s) and/or the Locker(s) in accordance with the Lease and with the bylaws, rules and regulations of the Strata Corporation, but only to the extent such bylaws, rules and regulations do not materially interfere with the Assignee's rights under the Lease and this Assignment.

4. Sale or Disposition

The Assignee may only assign its rights under this Assignment, and may only allow anyone else to use the Stall(s) and/or Locker(s), in accordance with the Lease.

5. Acknowledgement

The Assignee acknowledges having received a copy of the Lease and agrees to be fully bound by its terms.

6. Enurement

This Assignment will enure to the benefit of and be binding upon the parties hereto and their respective heirs, executors, administrators, successors and permitted assigns.

7. Capitalized Terms

Each capitalized term used herein which is defined in the Lease and not otherwise defined herein will have the meaning given to it in the Lease.

8. Counterparts

This Assignment may be executed in any number of counterparts, each of which will be deemed to be an original and all of which, taken together, will be deemed to constitute one and the same instrument.

9. Electronic Delivery

Delivery of an executed copy of this Assignment by any party by electronic transmission (including fax or e-mail) will be as effective as personal delivery of an originally executed copy of this Assignment by such party.

[Remainder of page left intentionally blank. Signature page follows.]

The parties have executed this Assignment effective as of the _____ day of _____, 20____.

Assignor

Assignee

EXHIBIT K
SUBDIVISION PLAN

See attached.

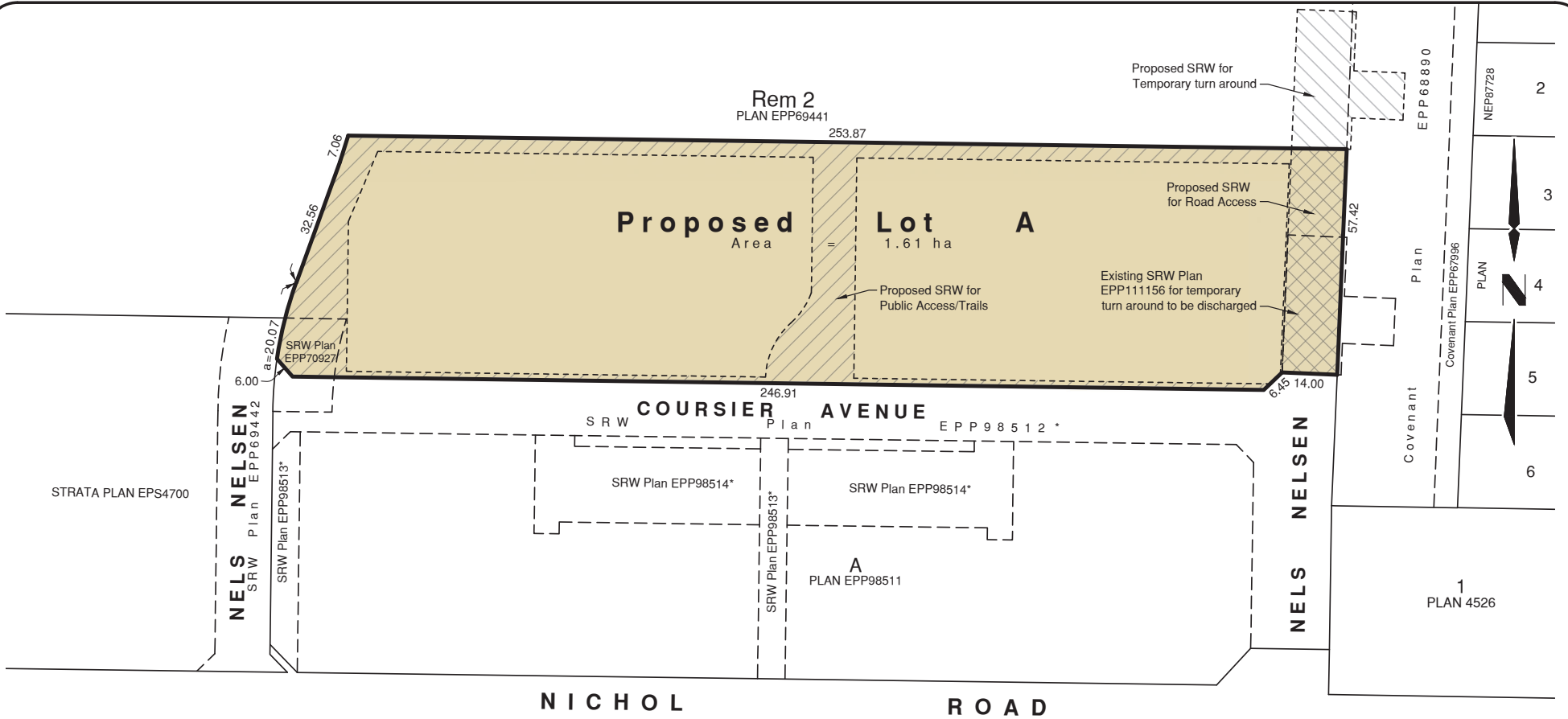

Note: * denotes unregistered Plan

0929468 BC Ltd.

MACKENZIE VILLAGE PHASE 4/5

PROPOSED SUBDIVISION OF PART OF LOT 2 SECTION 23 TOWNSHIP 23 RANGE 2 WEST OF THE 6TH MERIDIAN KOOTENAY DISTRICT PLAN EPP69441 EXCEPT PLAN EPP98511

October 18, 2022

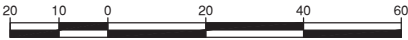

The intended plot size of this plan is 432mm in width by 279mm in height (B size) when plotted at a scale of 1:1000.

All distances are in metres and decimals thereof.

* All lot areas and dimensions are preliminary and subject to change upon final approvals from the owner/developer and applicable government agencies.

Certified Correct this 18th day of October, 2022

Anna Niraz, BCLS 964



Suite 700 - 1631 Dickson Avenue • Landmark 6
Kelowna, BC • V1Y 0B5
t: 250-469-7731 • www.geoverra.com

File: 22-03760-001-PSUB01

EXHIBIT L
PROPOSED PROJECT PLAN

See attached.

UPDATED DEC 2022 Mackenzie Village

Schedule D-1 Updated - Concept Plan

Legend

0m 20m 50m

Property Boundary	
Phase 1	7,375 m ²
Phase 2	8,815 m ² (inc SRWs)
Phase 3	8,933 m ² (inc SRWs)
Phase 4	5,811 m ² 6,392 m² (+10%)
Phase 5	5,552 m ² 6,107 m² (+10%)
Phase 6	9,795 m ²
Phase 7	12,435 m ² 11,234 m² (-9.7%)
Phase 8	7,324 m ² 6,722 m² (-8.22%)
Phase 9	9,595 m ² 8,699 m² (-9.34%)
Phase 10	9,911 m ²
Phase 11	15,539 m ² 14,524 m² (-6.53%)
Phase 12	16,604 m ² 16,041 m² (-3.39%)
Green Space	

Legal: REM S1/2 of NE 1/4 of SEC23, TP23, W 6M, KOOTENAY DISTRICT

Lot Area: 14.4 Hectares

D-1 Issued : March 25th, 2019

D-1 Re-Issued : December 10th, 2021

D-1 Re-Issued : March 18th, 2022

D-1 Re-Issued : July 30th, 2022

Master Development Agreement specified that each phase / sub area may be expanded or contracted by a maximum of 10%

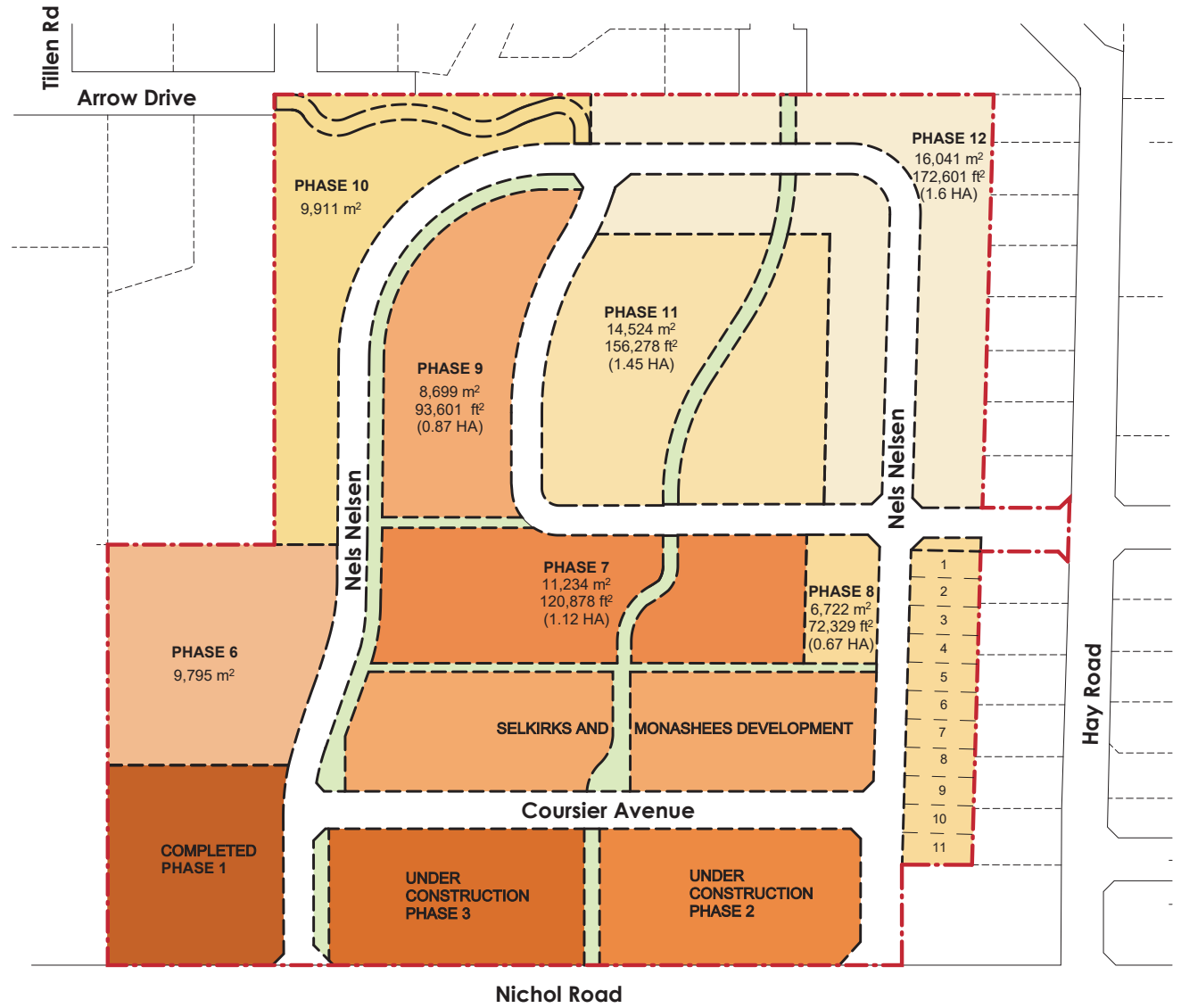

EXHIBIT M

Intentionally deleted.

EXHIBIT N

MACKENZIE VILLAGE COMMUNITY ASSOCIATION BYLAWS

See attached.



T.K. SPARKS

SOCIETIES ACT
BYLAWS OF
MACKENZIE VILLAGE COMMUNITY ASSOCIATION

WHEREAS:

- A. The Developer was previously the owner of the entire Lands;
- B. Prior to the date hereof, the Developer subdivided certain portions of the Lands to create Lots and has developed, or is in the process of developing, a separate Development within each such Lot;
- C. The Developer intends, in the future, to create additional Lots by subdividing the remaining portion of the Lands from time to time, and to develop a separate Development within each such Lot;
- D. The Association Members will be comprised of the owners of the Lots, and, upon the stratification of some or all of the Lots, the Strata Corporation created thereby;
- E. Through the granting of the Road and Trail System Private SRW, Residents will share and benefit from the use of, *inter alia*, the Road and Trail System, which will be administered by the Association; and
- F. The Association may, from time to time, enter into Community Agreements for the benefit of the Residents.

ARTICLE 1
INTERPRETATION

- 1.1 In these Bylaws, the terms defined in the recitals have the meanings set out therein and the following terms have the following meanings:
 - (a) **“Annual Shared Costs Budget”** has the meaning ascribed to such term in section 11.1;
 - (b) **“Annual Shared Costs Statement”** means the statement of the actual Shared Costs for a calendar year prepared by the directors of the Association pursuant to section 11.11;
 - (c) **“Association”** means the Mackenzie Village Community Association;
 - (d) **“Association Members”** means the members of the Association from time to time, and **“Association Member”** means any one of them; the Association Members are expected, in the normal course, to be corporations, Strata Corporations and, for any Occupied Lot not subdivided by way of Strata Plan, the owner of such Lot;
 - (e) **“Association Member Credited Costs”** has the meaning set out in section 11.18;
 - (f) **“Board”** means at any given time, all of the directors;

- (g) **“Budgeted Shared Costs”** means the budgeted amount of the Shared Costs for a calendar year, as determined by the directors of the Association pursuant to Section 11.1 and included in the Annual Shared Costs Budget;
- (h) **“Building”** means the building or buildings and other improvements located on a Lot from time to time;
- (i) **“Calculable Area”** means, for a given Lot, the total Habitable Area, in square metres, of all Buildings on such Lot, as determined by a British Columbia land surveyor, rounded to the nearest whole number (and, for greater certainty, for a Lot in respect of which a Strata Plan has been deposited in the Land Title Office, Calculable Area means the total Habitable Area, in square meters, of all strata lots created by the deposit of such Strata Plan);
- (j) **“Capital Repairs and Replacements”** means any Repairs that usually occur less often than once a year, or do not usually occur on a regular basis, and the cost of which would normally be capitalised rather than expensed in accordance with generally accepted accounting principals (GAAP) and **“Capital Repair and Replacement”** means any one of the Capital Repairs and Replacements;
- (k) **“City”** means the City of Revelstoke;
- (l) **“Community”** means the comprehensive community developed or to be developed on the Lands, comprised or to be comprised of the Developments, and known collectively as “Mackenzie Village”;
- (m) **“Community Agreement”** means any contract, agreement or other instrument entered into by the Association with respect to any of the following:
 - (i) the provision or operation of services to or for the Community (including, without limitation, bus service between the Community and any amenity area in or near Revelstoke, such as Revelstoke Mountain Resort); and
 - (ii) the construction, installation, management, operation, use, maintenance and/or repair of any Community Facilities,

and, for greater certainty, a Community Agreement may be registered on title to the Lands or any portion thereof or unregistered;
- (n) **“Community Agreement Party”** means any third party that enters into a Community Agreement with the Association, including, without limitation, the City, the Province of British Columbia or any other governmental or quasi-governmental authority, any Crown Corporation, any transit authority, any strata corporation, any public or private utility provider, any private company or firm or any other person;
- (o) **“Community Agreements Shared Costs”** means all costs and expenses incurred by the Association under the Community Agreements in observing and performing its covenants and obligations therein;
- (p) **“Community Facilities”** means common facilities, works, areas, utilities, systems, services and improvements located within the Community or which service or benefit the Community;

- (q) “**Community Rules**” means the rules and regulations with respect to the Road and Trail System and/or any Community Facilities as may be adopted from time to time by the Association;
- (r) “**Contingency Funds**” means the funds established by the directors pursuant to section 11.7 hereof, and “**Contingency Fund**” means any one of them;
- (s) “**Developer**” means 0929468 B.C. Ltd., or its designate, successor or assign;
- (t) “**Development**” means a development developed within a given Lot, and “**Developments**” means more than one such development or all of them, as the context requires;
- (u) “**directors**” means the director or directors of the Association from time to time;
- (v) “**EPS4700 Lands**” has the meaning set out in Schedule A attached hereto;
- (w) “**EPS4700 Strata Corporation**” means The Owners, Strata Plan EPS4700, being the strata corporation created under the *Strata Property Act* by the deposit of Strata Plan EPS4700 in respect of the EPS4700 Lands;
- (x) “**Existing Lot**” means each of the EPS4700 Lands, Lot A and Lot 2;
- (y) “**Facilities Manager**” has the meaning ascribed to such term in section 10.1;
- (z) “**Habitable Area**” means the area of a Building which can be lived in, but does not include patios, balconies, garages, parking stalls or storage areas other than closet space;
- (aa) “**Insurance Costs**” means the costs and expenses incurred by the Association in taking out, maintaining and replacing, from time to time, the insurance required to be maintained pursuant to the Road and Trail System Agreements and the Community Agreements, including, without limitation, the amount of deductibles, self-retention amounts and reimbursement requirements incurred or absorbed by the Association in respect of any insurance claim;
- (bb) “**Land Title Office**” means the Kootenay Land Title Office;
- (cc) “**Lands**” means those certain lands located in Revelstoke, British Columbia and legally described in Schedule A attached hereto;
- (dd) “**Lot**” means each subdivided portion of the Lands, and includes, for greater certainty:
 - (i) each Existing Lot; and
 - (ii) each legal parcel created by any subdivision of Lot 2 from time to time,
 and “**Lots**” means more than one Lot or all of them, as the context requires, but “**Lot**” does not include a strata lot created by the deposit of a Strata Plan in respect of a Lot;
- (ee) “**Lot A**” has the meaning set out in Schedule A attached hereto;

- (ff) “**Lot 2**” has the meaning set out in Schedule A attached hereto;
- (gg) “**Non-Paying Member**” has the meaning set out in section 11.9(b);
- (hh) “**Non-Voting Member**” means each of those Association Members as set out in section 2.4(b);
- (ii) “**Occupied Lot**” has the meaning set out in section 11.14;
- (jj) “**ordinary resolution**” means a vote in favour of a resolution by more than ½ of the votes cast by Association Members who are voting members in good standing who are present in person or by proxy at the time the vote is taken;
- (kk) “**Receipt Date**” has the meaning set out in section 11.9(a);
- (ll) “**Repair**” means to:
 - (i) alter, demolish, install, place, reconstruct, replace, remove or renew and all other activities or other work incidental or related thereto;
 - (ii) inspect, examine, monitor and/or test;
 - (iii) service, maintain and keep in good order and proper state;
 - (iv) clean, tidy up and sanitize;
 - (v) keep free of refuse, vermin and hazards;
 - (vi) repair or replace as reasonably necessary or advisable, including, without limitation, routine and ongoing repairs and Capital Repairs and Replacements;
 - (vii) upgrade anything when reasonably necessary or advisable;
 - (viii) attend to snow and ice removal, salting, sanding and similar services,
 and all derivatives of “**Repair**” have corresponding meanings;
- (mm) “**Road and Trail System**” means the road system and pedestrian trail system, including all related or incidental utilities and improvements, located within the Community constructed, or to be constructed, by the Developer concurrently with the construction of the Developments;
- (nn) “**Road and Trail System Agreements**” means, together, the Road and Trail System Public SRW and the Road and Trail System Private SRW, and “**Road and Trail System Agreement**” means either of them;
- (oo) “**Road and Trail System Private SRW**” means, collectively, all statutory rights of way with respect to the Road and Trail System granted from time to time by any Association Member in favour of the Association over the Lands, or any portion thereof, as such statutory rights of way may be modified, replaced, partially discharged and/or supplemented from time to time;

- (pp) **“Road and Trail System Private SRW Shared Costs”** means all costs and expenses incurred by the Association under the Road and Trail System Private SRW in observing and performing its covenants and obligations therein;
- (qq) **“Road and Trail System Public SRW”** means, collectively, all statutory rights of way with respect to the Road and Trail System granted from time to time by any Association Member in favour of the City over the Lands, or any portion thereof, as such statutory rights of way may be modified, replaced, partially discharged and/or supplemented from time to time;
- (rr) **“Road and Trail System Public SRW Shared Costs”** means all costs incurred by the Association in observing and performing the covenants and obligations of the grantors under the Road and Trail System Public SRW;
- (ss) **“Prime Rate”** means at any time, the per annum rate of interest published by the main branch in the City of Vancouver of the Bank of Montreal or its successor at such time as its reference rate for setting rates of interest on loans in Canadian dollars and referred to by such bank as its “Prime Rate”, provided however, that if such bank publishes more than one reference rate at any time, the Prime Rate will be the highest thereof;
- (tt) **“registered address”** of an Association Member means the member’s address as recorded in the Association’s register of members;
- (uu) **“Residents”** means all of those persons who reside from time to time in the Community;
- (vv) **“Shared Costs”** means the aggregate, without duplication, of:
- (i) the Road and Trail System Private SRW Shared Costs;
 - (ii) the Road and Trail System Public SRW Shared Costs;
 - (iii) the Association Member Credited Costs;
 - (iv) the Community Agreements Shared Costs;
 - (v) all costs and expenses incurred in respect of the operations of the Association in accordance herewith, including, without limitation, all costs and expenses incurred in observing and performing its obligations under section 8.4 and Insurance Costs; and
 - (vi) any other costs and expenses which are expressly stated herein to be shared by the Association Members;
- (ww) **“Shared Costs Payments”** means the payments to be made by the applicable Association Members on account of their respective percentage of the Shared Costs in accordance with section 11.12;
- (xx) **“Societies Act”** means the *Societies Act* (British Columbia) from time to time in force and all amendments to it and the regulations thereto;

- (yy) “**special resolution**” means a vote in favour of a resolution by at least $\frac{3}{4}$ of the votes cast by Association Members who are voting members in good standing and who are present in person or by proxy at the time the vote is taken;
- (zz) “**Strata Members**” means Association Members which are Strata Corporations;
- (aaa) “**Strata Corporation**” means a strata corporation created under the Strata Property Act;
- (bbb) “**Strata Plan**” means a strata plan under the Strata Property Act (including, without limitation and for greater certainty, a bare land strata plan);
- (ccc) “**Strata Property Act**” means the *Strata Property Act* (British Columbia), as such Act may be amended from time to time;
- (ddd) “**Transition Date**” means the date which is the earlier of:
 - (i) December 31, 2122; and
 - (ii) the date on which the Developer gives written notice to the Association that the Developer has either (i) completed the development of all Buildings in the Community and that occupancy permits have been issued by the City with respect to all Buildings in the Community or (ii) elected to cease any further development of the Community; and
- (eee) “**Voting Member**” means each of those Association Members as set out in section 2.4(a).

- 1.2 Words importing the singular include the plural and vice versa, and words importing a male person include a female person and a corporation.
- 1.3 If there is a conflict or inconsistency between these Bylaws and the *Societies Act*, the *Societies Act* will govern and prevail.
- 1.4 Any reference to a statute or bylaw of any governmental authority will include and will be deemed to be a reference to such statute or bylaw and to the regulations or orders made pursuant thereto and all amendments made thereto and in force from time to time, and to any statute, bylaw, regulation or order that may be passed which has the effect of supplementing the statute or bylaw so referred to or the regulations or orders made pursuant thereto.

ARTICLE 2 ASSOCIATION MEMBERSHIP

- 2.1 The Association Members are the applicants for incorporation of the Association, and those persons who subsequently become Association Members, in accordance with these Bylaws and, in either case, have not ceased to be Association Members.
- 2.2 Membership in the Association is restricted to the following corporations, persons or bodies:
 - (a) the registered owner(s) of any Lot; and

- (b) any Strata Corporation created upon the deposit of a Strata Plan with respect to any Lot (including, for greater certainty, any such Strata Corporation created prior to or following the date hereof).
- 2.3 Every Association Member must uphold the constitution and comply with these Bylaws.
- 2.4 There will be two classes of membership in the Association and the directors may, at any time, establish new sub-classes of either class of membership. The two classes of membership include:
- (a) **Voting Member.** Until the Transition Date, the one Voting Member of the Association will be the Developer. Voting Members will be entitled to vote at meetings of the Association.
 - (b) **Non-Voting Member.** Until the Transition Date, each Association Member other than the Developer will be a Non-Voting Member. Non-Voting Members will not be entitled to vote at meetings of the Association.
- 2.5 An Association Member ceases to be an Association Member:
- (a) if the Association Member is the owner of a Lot, on the deposit of a Strata Plan with respect to such Lot, as contemplated in section 2.7(b);
 - (b) in the case of a corporation, partnership or a Strata Corporation, on its dissolution or winding up; or
 - (c) as contemplated under section 2.7(b), 2.7(c) or 2.7(e).
- For greater certainty, an Association Member cannot, and will not, elect to cease to be an Association Member and the only situations in which an Association Member ceases to be an Association Member are set out in this section 2.4.
- 2.6 Any Association Member who ceases to be a member of the Association forfeits all rights, claims, privileges or interests arising from membership in the Association.
- 2.7 The Lands are intended to be developed over a period of time. Accordingly:
- (a) as and when the Lands are subdivided, other than by way of a Strata Plan, the registered owner(s) of the subdivided Lots will automatically become Association Members upon the registration of the subdivision plan without further action;
 - (b) as and when any Lot is subdivided by way of Strata Plan, the Strata Corporation created as a result of the deposit of such Strata Plan in the Land Title Office will automatically become an Association Member upon its creation and the registered owner(s) of such Lot immediately prior to such subdivision will automatically cease to be the Association Member for such Lot without further action (provided that, for greater certainty, if such registered owner(s) is/are the registered owner(s) of any other Lot, such registered owner(s) will continue to be an Association Member in its capacity as the registered owner(s) of such other Lot);
 - (c) an Association Member that sells any Lot will notify the Association of such sale, and require as a condition of sale that the transferee of such Lot agrees to

become an Association Member of the Association concurrently with the completion of the transaction, and, upon the completion of such sale, the transferee of such Lot will automatically become an association member and the selling Association Member will automatically cease to be the Association Member for such Lot without further action (provided that, for greater certainty, if the selling Association Member is/are the registered owner(s) of any other Lot, such selling Association Member will continue to be an Association Member in its capacity as the registered owner(s) of such other Lot);

- (d) corporations, partnerships and Strata Corporations which are being dissolved or wound up will notify the Association prior to being dissolved or wound up, and ensure that their successors, if any, become Association Members; and
- (e) if applicable, the membership of an individual Association Member will be transferred and assigned upon the death of such Association Member to his or her beneficiary, and such deceased individual will automatically cease to be an Association Member without further action.

2.8 All Association Members are in good standing, except an Association Member who has failed to pay its percentage allocation of the Shared Costs, or any other subscription or debt due and owing by the Association Member to the Association, and the Association Member is not in good standing so long as the debt remains unpaid.

2.9 Notwithstanding anything to the contrary set forth herein:

- (a) until the Transition Date:
 - (i) the Developer will be the only Voting Member, and each other Association Member will be a Non-Voting Member; and
 - (ii) if the Developer is present at a general meeting, then there will be deemed to be a quorum; and
- (b) from and after the Transition Date, each Association Member who is at that time a Non-Voting Member will automatically become a Voting Member (without the need for any further documentation whatsoever) and the directors will accept such Association Member as a Voting Member.

2.10 Notwithstanding anything to the contrary set forth herein:

- (a) at the time the Association is incorporated, the only Association Member will be the Developer, being the registered owner of Lot A and Lot 2;
- (b) notwithstanding subsection 2.7(b), at the time the Association is incorporated, the EPS4700 Strata Corporation will not be an Association Member, and the EPS4700 Strata Corporation will not become an Association Member unless and until the Voting Member approves the admission of the EPS4700 Strata Corporation as an Association Member (and, for greater certainty, the owners of the strata lots in Strata Plan EPS4700 will not be, and are not in any circumstances entitled to become, Association Members); and
- (c) for greater certainty, unless and until the EPS4700 Strata Corporation becomes an Association Member:

- (i) the Association will not be responsible for administering, operating, managing, maintaining or repairing any portion of the Road and Trail System located on the EPS4700 Lands, nor will the Association have any other obligations or liabilities with respect to the EPS4700 Lands or any portion of the Road and Trail System located thereon; and
- (ii) the EPS4700 Strata Corporation and the Residents of the Development on the EPS4700 Lands and their invitees, guests and visitors will not be entitled to exercise any rights of the Association under the Road and Trail System Private SRW.

**ARTICLE 3
MEETINGS OF ASSOCIATION MEMBERS**

- 3.1 General meetings of the Association must be held at the time and place, in accordance with the *Societies Act*, that the directors decide.
- 3.2 Each Association Member will be represented by one representative at all meetings of the Association.
- 3.3 Every general meeting, other than an annual general meeting, is an extraordinary general meeting.
- 3.4 The Association will, not less than sixty (60) days before it holds a general meeting at which directors are to be appointed, publish, in a manner approved by the directors, an advance notice of the meeting.
- 3.5 The directors may, when they think fit, convene an extraordinary general meeting, and will upon a requisition in writing of ten (10%) percent of the Association Members call an extraordinary general meeting without delay.
- 3.6 At least fifteen (15) days' notice of a general meeting specifying the place, day and hour of the meeting, and, in case of special business, the general nature of that business, will be given to all Association Members.
- 3.7 The accidental omission to give notice of a meeting, or the accidental omission to deliver a proxy or ballot, if required, or the non-receipt of a notice by, any of the Association Members entitled to receive notice does not invalidate proceedings at that meeting.
- 3.8 The first annual general meeting of the Association must be held not more than fifteen (15) months after the date of incorporation of the Association and after that an annual general meeting must be held at least once in every calendar year and not more than fifteen (15) months after the holding of the last preceding annual general meeting.

**ARTICLE 4
PROCEEDINGS AT GENERAL MEETINGS**

- 4.1 Special business is:
 - (a) all business at an extraordinary general meeting except the adoption of rules of order; and
 - (b) all business conducted at an annual general meeting, except the following:

- (i) the adoption of rules of order;
- (ii) the consideration of the financial statements;
- (iii) the report of the directors;
- (iv) the report of the auditor, if any;
- (v) the appointment of directors pursuant to section 5.3;
- (vi) the appointment of the auditor, if required; and
- (vii) the other business that, under these Bylaws, ought to be conducted at an annual general meeting, or business that is brought under consideration by the report of the directors issued with the notice convening the meeting.

4.2

- (a) Business, other than the election of a chair and the adjournment or termination of the meeting, must not be conducted at a general meeting at a time when a quorum is not present.
- (b) If at any time during a general meeting there ceases to be a quorum present, business then in progress must be suspended until there is a quorum present or until the meeting is adjourned or terminated.
- (c) Subject to section 2.9 and 4.3 and, a quorum is the lesser of:
 - (i) all Association Members; and
 - (ii) seven Association Members in good standing who are present in person or by proxy, including not less than one Voting Member, or such greater number as the Association Members may determine at a general meeting.

4.3 If within thirty (30) minutes from the time appointed for a general meeting a quorum is not present, the meeting, if convened on the requisition of Association Members, must be terminated, but in any other case, it must stand adjourned to the same day in the next week, at the same time and place, and if, at the adjourned meeting, a quorum is not present within thirty (30) minutes from the time appointed for the meeting, the Association Members present constitute a quorum provided at least one Voting Member is in attendance.

4.4 Subject to section 4.5, the president of the Association, the vice president or, in the absence of both, one of the other directors present, must preside as chair of a general meeting.

4.5 If at a general meeting:

- (a) there is no president, vice president or other director present within fifteen (15) minutes after the time appointed for holding the meeting; or

(b) the president and all the other directors present are unwilling to act as the chair; the Association Members present must choose one of their number to be the chair.

4.6

- (a) A general meeting may be adjourned from time to time and from place to place, but business must not be conducted at an adjourned meeting other than the business left unfinished at the meeting from which the adjournment took place.
- (b) When a meeting is adjourned for ten (10) days or more, notice of the adjourned meeting must be given as in the case of the original meeting.
- (c) Except as provided in this bylaw, it is not necessary to give notice of an adjournment or of the business to be conducted at an adjourned general meeting.

4.7

- (a) A resolution proposed at a meeting need not be seconded, and the chair of a meeting may move or propose a resolution.
- (b) In the case of a tie vote, the chair does not have a casting or second vote in addition to the vote to which he or she may be entitled as an Association Member, and the proposed resolution does not pass.

4.8 Subject to section 2.9, each Voting Member in good standing present at a meeting of Association Members is entitled to one (1) vote.

4.9 A Voting Member which is a corporation or a Strata Corporation may vote by its authorized representative, strata council member or director respectively who is entitled to speak and vote, and in all other respects exercise the rights of an Association Member, and that representative, strata council member or director must be considered as an Association Member for all purposes with respect to a meeting of the Association.

4.10 Voting will be by ballot provided that at any meeting of the Association, the Voting Members may agree to vote by a show of hands on any issue including a special resolution. Every ballot cast upon a poll and every proxy appointing a proxyholder who casts a ballot upon a poll will be retained by the Secretary for a period of three (3) months after the meeting and will be subject to inspection at the office of the Association during normal business hours or through electronic means.

4.11 Voting by proxy is permitted. Every Voting Member entitled to vote at a general meeting will be entitled to appoint by proxy a proxyholder to attend, act and vote for them at such meeting, subject to:

- (a) in the case of a general power of proxy for voting on resolutions at a meeting, an individual proxyholder may represent not more than five (5) Voting Members at the meeting, save and except if the proxyholder is a director;
- (b) a permanent proxy or proxy entitling a person or Voting Member to vote at other than one meeting and any adjournment of that meeting is void; and

(c) these Bylaws.

4.12

(a) An instrument appointing a proxy will be in writing under the hand of the appointer or his or her lawfully appointed attorney and may be either general, for a particular meeting or for a particular resolution at a particular meeting.

(b) A proxyholder will be an Association Member.

4.13 The original or valid copy of an instrument appointing a proxyholder may be deposited prior to the commencement of the meeting at such place as is specified for that purpose in the notice calling the meeting or with the chair of the meeting, the Secretary of the Board or be sent to the Association in writing so as to arrive before the commencement of the meeting or adjourned meeting at the registered office of the Association and also providing that proxies so deposited may be acted upon as though the proxies themselves were deposited as required by these Bylaws, and votes given in accordance with such regulation will be valid and will be counted.

4.14 A proxy, whether for a specified meeting or otherwise, will be in the following form, or in such other form that the directors will approve:

MACKENZIE VILLAGE COMMUNITY ASSOCIATION
The undersigned, being a member of the above Association hereby appoints _____ or failing this person, _____ as proxyholder for the undersigned to attend, act and vote for and on behalf of the undersigned at the general meeting of the Association to be held on _____ , 20__ and at any adjournment thereof.
Signed this _____, 20__
(Signature of Member)

4.15 A vote given in accordance with the terms of a proxy is valid notwithstanding the previous death or incapacity of the Voting Member giving the proxy or the alleged revocation of the proxy or of the authority under which the instrument of proxy was executed unless notification in writing of such death, incapacity or revocation will have been received at the registered office of the Association or by the chair of the meeting or adjourned meeting for which the proxy is given before the vote is taken.

4.16 Every proxy may be revoked by an instrument in writing:

(a) executed by the Association Member giving the same, and

(b) delivered either at the business office of the Association at any time up to and including the last business day preceding the day of the meeting or adjourned meeting for which the proxy is given, or to the chair of the meeting on the day of the meeting or any adjournment thereof before any vote in respect of which the proxy is given will have been taken.

- 4.17 The directors may, but will not be obligated to, solicit proxies prior to any meetings of the Association Members. The solicitation of proxies may be undertaken in person or as provided in Article 15 below.
- 4.18 The solicitation of proxies referred to in section 4.17 will take place at any time commencing with the notice of an Association Members' meeting which has been given pursuant to section 3.6 and may continue up to and including the date of such Association Members' meeting.
- 4.19 At any meeting of the Association, Voting Members may vote on any issue that arises by a show of hands, including a special resolution.
- 4.20 Any issue at a general meeting which is not required by these Bylaws or the *Societies Act* to be decided by a special resolution will be decided by an ordinary resolution. Notwithstanding the foregoing, in addition to an ordinary resolution, approval by a special resolution of the Association Members requiring at least a $\frac{3}{4}$ of the votes cast will be required for decisions relating to the following matters and other matters as specified herein:
- (a) hiring or termination of the Facilities Manager; and
 - (b) enactment, amendment or repeal of any Community Rules.

ARTICLE 5 DIRECTORS AND OFFICERS

5.1

- (a) The directors may exercise all the powers and do all the acts and things that the Association may exercise and do, and that are not by these Bylaws or by statute or otherwise lawfully directed or required to be exercised or done by the Association in a general meeting, but subject, nevertheless, to:
 - (i) all laws affecting the Association;
 - (ii) these Bylaws;
 - (iii) Community Rules;
 - (iv) rules, not being inconsistent with these Bylaws, that are made from time to time by the Association in a general meeting;
 - (v) the Road and Trail System Agreements; and
 - (vi) the Community Agreements.
- (b) A rule made by the Association in a general meeting does not invalidate a prior act of the directors that would have been valid if that rule had not been made.

5.2

- (a) The Association may have a president, vice president, secretary, treasurer and such other officers as the directors may appoint, all of whom must be directors

and who will be appointed by the directors. The offices of secretary and treasurer may be held by one (1) person who will be known as the secretary-treasurer.

- (b) Any Association Member (and in the case of an Association Member which is a corporation or Strata Corporation, its authorized representative, strata council member or director respectively) in good standing is eligible for appointment as a director.

5.3 The directors of the Association will be appointed as directors of the Association in accordance with the following:

- (a) prior to the Transition Date, the Association will have one (1) director, which director will be appointed by the Developer; and
- (b) from and after the Transition Date, each Association Member will appoint one (1) director. Any Association Member that is a Strata Corporation will appoint its director in accordance with such Strata Corporation's bylaws in force from time to time.

5.4 Each director of the Association must be qualified for appointment pursuant to the terms of the *Societies Act*.

5.5

- (a) Each director must retire from office at each annual general meeting, at which time the Association Member that appointed such director will appoint a new director in accordance with section 5.3. Retiring directors are eligible for re-appointment at the meeting.
- (b) If at any time there is a vacancy in the directors, the Association Member that appointed the director who has vacated will appoint a replacement director in accordance with section 5.3.
- (c) A director appointed by an Association Member to fill a vacancy, including a director appointed pursuant to section 5.5(b), section 5.6 or section 5.8, holds office only until the conclusion of the next annual general meeting of the Association, but is eligible for re-appointment at the meeting.

5.6 If a director resigns from his or her office or otherwise ceases to hold office before the expiration of his or her term of office, the Association Member that appointed such director will appoint a replacement director in accordance with section 5.3.

5.7 No act or proceeding of the directors is invalid only by reason of there being less than the prescribed number of directors in office.

5.8 The Association Members may by special resolution remove a director before the expiration of his or her term of office, and the Association Member that appointed the director who has been removed will appoint a replacement director in accordance with section 5.3.

5.9 Every director will uphold the constitution of the Association and comply with these Bylaws. Each director will:

- (a) act honestly and in good faith and in the best interest of the Association;
 - (b) exercise the care, diligence and skill of a reasonably prudent person, in exercising the powers and performing the functions as a director; and
 - (c) declare any real or potential conflict of interest and withdraw from any meeting or vote during which any matters related to such conflict are discussed or voted upon.
- 5.10 A director must not be remunerated for being or acting as a director but a director must be reimbursed for all expenses necessarily and reasonably incurred by the director while engaged in the affairs of the Association.

ARTICLE 6 PROCEEDINGS OF DIRECTORS

6.1

- (a) The directors may meet at the places they think fit to conduct business, including by way of teleconference or videoconference, and may adjourn and otherwise regulate their meetings and proceedings, as they see fit. The directors will be given reasonable notice of the date, time and location of the meetings of the directors.
- (b) The directors may from time to time set the quorum necessary to conduct business, and unless so set the quorum is a majority of the directors then in office.
- (c) The president is the chair of all meetings of the directors, but if at a meeting the president is not present within thirty (30) minutes after the time appointed for holding the meeting, the vice president must act as chair, but if neither is present the directors present may choose one of their number to be the chair at that meeting.
- (d) A director may at any time, and on the request of a director the secretary must, convene a meeting of the directors.

6.2 For a first meeting of directors held immediately following the appointment of a director or directors at an annual or other general meeting of Association Members, it is not necessary to give notice of the meeting to the newly appointed director or directors for the meeting to be constituted, if a quorum of the directors is present.

6.3 A director who may be absent temporarily from British Columbia may send or deliver to the address of the Association a waiver of notice, which may be by letter, facsimile or e-mail, of any meeting of the directors and may at any time withdraw the waiver, and until the waiver is withdrawn:

- (a) a notice of meeting of directors is not required to be sent to that director; and
- (b) any and all meetings of the directors of the Association, notice of which has not been given to that director, if a quorum of the directors is present, are valid and effective.

- 6.4
- (a) Questions arising at a meeting of the directors and committee of directors must be decided by a majority of votes.
 - (b) In the case of a tie vote, the chair does not have a second or casting vote.
- 6.5 A resolution proposed at a meeting of directors or committee of directors need not be seconded, and the chair of a meeting may move or propose a resolution.
- 6.6 A resolution in writing, signed by all the directors and placed with the minutes of the directors, is as valid and effective as if regularly passed at a meeting of directors.
- 6.7
- (a) The directors may delegate any, but not all, of their powers to committees consisting of the director or directors as they think fit.
 - (b) A committee so formed in the exercise of the powers so delegated must conform to any rules imposed on it by the directors, and must report every act or thing done in exercise of those powers to the earliest meeting of the directors held after the act or thing has been done.
- 6.8 A committee must elect a chair of its meetings, but if no chair is elected, or if at a meeting the chair is not present within thirty (30) minutes after the time appointed for holding the meeting, the directors present who are members of the committee must choose one of their number to be the chair of the meeting.
- 6.9
- (a) Questions arising at a meeting of a committee must be decided by a majority of votes.
 - (b) In the case of a tie vote, the chair of the committee will have a second or casting vote.
- 6.10 The members of a committee may meet and adjourn as they think proper.
- 6.11 No resolution proposed at a meeting of a committee need be seconded and the chair of a meeting may move or propose a resolution.

ARTICLE 7 DUTIES OF DIRECTORS AND OFFICERS

- 7.1 The directors will:
- (a) make such Community Rules as the directors consider necessary or desirable from time to time relating to the purposes of the Association, provided that the Community Rules will not, and the directors will not pass any Community Rules that, contradict, conflict with or offend the provisions of any of the Road and Trail System Agreements or the Community Agreements or any applicable municipal, provincial or federal rule or regulation, and any Community Rules that contradict, conflict with or offend the provisions of any of the Road and Trail System

Agreements or the Community Agreements or any applicable municipal, provincial or federal rule or regulation will be of no force or effect; and

- (b) cause the Association to exercise its rights, remedies and discretions, and to perform its obligations under any agreements the Association makes with any person including the City.

7.2

- (a) The president presides at all meetings of the Association and of the directors.
- (b) The president is the chief executive officer of the Association and must supervise the other officers in the execution of their duties.

7.3 The vice president must carry out the duties of the president during the president's absence.

7.4 The secretary must do the following:

- (a) conduct the correspondence of the Association;
- (b) issue notices of meetings of the Association and directors;
- (c) keep minutes of all meetings of the Association and directors;
- (d) have custody of all records and documents of the Association except those required to be kept by the treasurer;
- (e) have custody of the common seal of the Association; and
- (f) maintain the register of Association Members.

7.5 The treasurer must:

- (a) keep the financial records, including books of account, necessary to comply with the *Societies Act*; and
- (b) render financial statements to the directors, Association Members and others when required.

7.6 In the absence of the secretary from a meeting, the directors must appoint another person to act as secretary at the meeting.

7.7 All acts done in good faith by the directors are, notwithstanding that it be afterwards discovered that there was some defect in the appointment or continuance in office of the directors, as valid as if the directors had been duly appointed or had duly continued in office.

7.8 No director will be personally liable for any act done in good faith in carrying out his or her duties as a director.

**ARTICLE 8
ROAD AND TRAIL SYSTEM**

- 8.1 Capitalized terms used in this Article 8 and not otherwise defined in these Bylaws will have the respective meanings ascribed to such terms in the applicable Associations Agreement.
- 8.2 Subject to section 8.3, provided that an Association Member has complied with its obligations hereunder, such Association Member (or, in respect of a Strata Member, the Residents of such Strata Member's Development) and their invitees, guests and visitors, may exercise the rights of the Association under the Road and Trail System Private SRW in order to have access to and use of the Road and Trail System on each Lot that is subject to the Road and Trail System Private SRW in common with all other Association Members and Residents and their invitees, guests and visitors.
- 8.3 The Lands are intended to be developed over a period of time and permits from the City are required to construct the Road and Trail System. Accordingly, the Association Members and the Residents and their invitees, guests and visitors will not have access to or use of any given portion of the Road and Trail System until:
- (a) occupancy permits have been issued for all Buildings located on the Lot on which such portion of the Road and Trail System is located; and
 - (b) the Developer has determined that such portion of the Road and Trail System is ready to be made available for use.
- 8.4 The Association will be responsible for Repairing, and administering, operating and managing the use of, the Road and Trail System located on Association Members' Lots and, without limiting the foregoing, the Association will be responsible for:
- (a) observing and performing all of its covenants and obligations under the Road and Trail System Private SRW; and
 - (b) observing and performing all of the covenants and obligations of the grantor(s) under the Road and Trail System Public SRW.
- 8.5 The Association may exercise its rights under the Road and Trail System Private SRW in order to carry out its obligations hereunder and any obligations under the Road and Trail System Agreements, including, without limitation, Repairing the Road and Trail System.
- 8.6 The Association may from time to time pass, amend, rescind and enforce reasonable Community Rules with respect to the access to, use of and operation of the Road and Trail System, provided that such Community Rules are of general application, are fairly and uniformly enforced by the Association and do not contradict, conflict with or offend the provisions of any of the Road and Trail System Agreements.
- 8.7 The Association may negotiate, make arrangements and enter into contracts and agreements with third parties with respect to the provision of services, labour, materials and/or supplies in respect of the Association's rights and obligations hereunder and/or in connection with the Road and Trail System Agreements, including, without limitation, Repairing the Road and Trail System.

- 8.8 In the dealings referred to in section 8.7, the directors may act at their complete discretion provided that the arrangements made are commercially reasonable.

ARTICLE 9 COMMUNITY AGREEMENTS AND COMMUNITY FACILITIES

- 9.1 The Association may, from time to time, enter into such Community Agreements as the directors of the Association deem necessary or desirable, on such terms and conditions, and with such Community Agreement Parties, as the directors of the Association determine to be acceptable. Without limiting the foregoing, the Association may enter into one or more Community Agreements in order to:
- (a) arrange for the provision or operation of services to or for the Community (including, without limitation, bus service between the Community and any amenity area in or near Revelstoke, such as Revelstoke Mountain Resort); or
 - (b) take responsibility for any Community Facilities, including the construction, installation, management, operation, use, maintenance and/or repair of any Community Facilities.
- 9.2 The Association will be responsible for observing and performing all of its covenants and obligations under each Community Agreement.
- 9.3 The Association may from time to time pass, amend, rescind and enforce reasonable Community Rules with respect to Community Facilities that are the responsibility of the Association pursuant to a Community Agreement, provided that such Community Rules are of general application, are fairly and uniformly enforced by the Association and do not contradict, conflict with or offend the provisions of any of Community Agreements relating to such Community Facilities.

ARTICLE 10 FACILITIES MANAGER AND INSURANCE

- 10.1 The Association may delegate any or all of its rights, duties and obligations under Article 8 , Article 9 , the Road and Trail System Private SRW and/or any Community Agreement to a property manager (the “**Facilities Manager**”), which Facilities Manager will be hired and terminated in accordance with section 4.20(a).
- 10.2 In the dealings referred to in section 10.1, the directors may act at their complete discretion provided that the arrangements made are commercially reasonable.
- 10.3 The Association will take out and keep in full force and effect, or cause to be maintained, such insurance as the Association is required to take out and maintain to comply with its obligations hereunder or under the Road and Trail System Agreements or the Community Agreements.

ARTICLE 11 SHARED COSTS

- 11.1 The directors of the Association will prepare a budget (the “**Annual Shared Costs Budget**”) of the Shared Costs that are anticipated to be incurred for each calendar year. The Annual Shared Costs Budget will have separate line items for each component of “Shared Costs” as set out in the definition thereof in section 1.1 of this Agreement.

- 11.2 The Association will deliver the Annual Shared Costs Budget to each Association Member no later than sixty (60) days before the beginning of the calendar year for which such Annual Shared Costs Budget has been prepared.
- 11.3 The Annual Shared Costs Budget will identify:
- (a) each item in reasonable detail, including at a minimum, the Shared Costs and the amount to be contributed to the Contingency Funds during the applicable period;
 - (b) the percentage increase in the Shared Costs for each item for the next calendar year from the Annual Shared Costs Budget for the current calendar year; and
 - (c) the monthly amounts payable by each Association Member on account of the Shared Costs for the next calendar year, based on the applicable percentage allocation set forth in section 11.12.
- 11.4 The Annual Shared Costs Budget for a given calendar year must be approved by ordinary resolution at a general meeting, failing which the Association Members will be deemed to have approved, as the Annual Shared Costs Budget for such calendar year, the approved Annual Shared Costs Budget for the previous calendar year plus an increase of 5%.
- 11.5 In preparing the Annual Shared Costs Budget and maintaining its accounting records, the Association may create a category of "Miscellaneous Supplies" for the purchase and use of small supplies and replacement parts which will be used in carrying out the Association's obligations hereunder.
- 11.6 Each Association Member will pay its respective Shared Costs Payments to the Association in equal monthly installments, within ten (10) days following the beginning of each calendar month during the applicable calendar year, unless and until the Association is dissolved, or liquidated and dissolved.
- 11.7 The Association will, on behalf of the Association Members, establish and hold separate reserve funds (each a "**Contingency Fund**" and collectively, the "**Contingency Funds**") to cover the Association Members' share of the costs of anticipated Capital Repairs and Replacements for (a) the Road and Trail System and (b) those Community Facilities, if any, that are the responsibility of the Association pursuant to a Community Agreement. Subject to section 11.8, each Contingency Fund will be established through regular monthly contributions paid to the Association by each Association Member in accordance with section 11.12 hereof in an amount sufficient to meet such Association Member's share of the anticipated costs of the applicable Capital Repairs and Replacements when such Capital Repairs and Replacements are expected to occur and based on the normal life expectancy of the components of the Road and Trail System and the Community Facilities, as the case may be, as determined by the Association or the Facilities Manager, to the standard of a prudent manager. The Association will, on receipt, deposit the monthly contributions to each Contingency Fund in a separate bank account and hold such funds, together with any interest earned thereon, as trustee for the Association Members.
- 11.8 Notwithstanding anything contained herein to the contrary, commencing in the year following the Transition Date and continuing thereafter, the aggregate amount of the funds in the Contingency Funds will not be less than ten (10%) percent of the total amount of the previous calendar year's Annual Shared Costs Budget.

- 11.9 If, as and when any Capital Repairs and Replacements for which a Contingency Fund has been established are required and have been made, each Association Member's portion of the Shared Costs thereof, as determined in accordance with section 11.12 hereof, will be paid from the applicable Contingency Fund at the same time, and only when each Association Member pays its portion of such Shared Costs as determined in accordance with section 11.12 hereof. If there are insufficient funds available in a Contingency Fund to pay an Association Member's portion of the Shared Costs of any Capital Repairs and Replacements:
- (a) the funds in the Contingency Fund, if any, will be applied first against such Association Member's portion of the Shared Costs of such Capital Repairs and Replacements and the Association Member will pay the balance required to the Association on or before the date (the "**Receipt Date**") that is thirty (30) days after receipt of the invoice therefor together with a description of the applicable Capital Repairs and Replacements and an estimate of the cost to complete such Capital Repairs and Replacements; or
 - (b) if an Association Member (each, a "**Non-Paying Member**") fails to pay its portion of such Shared Costs required by the Association on or before the Receipt Date, then the directors of the Association may, in their sole discretion:
 - (i) decide not to commence such Capital Repairs and Replacements until the Non-Paying Member has paid its portion of such Shared Costs;
 - (ii) in accordance with, and subject to, Article 13 hereof, elect to borrow the amount of the Non-Paying Member's portion of such Shared Costs, and such Non-Paying Member will be responsible for all borrowing costs, including, without limitation, commitment fees, legal fees, repayment of principal for such borrowing and payment of interest charges, and will pay such amounts to the Association forthwith upon demand; or
 - (iii) require the other Association Members to pay the Non-Paying Member's portion of such Shared Costs, and such Non-Paying Member will then be responsible for reimbursing each other Association Member for the portion of such Shared Costs paid by such other Association Member together with interest thereon calculated from the Receipt Date until such Non-Paying Member reimburses such other Association Member in full at the following rates: (a) at the Prime Rate plus four percent (4%) per annum for a period of thirty (30) days after the Receipt Date; and (b) thereafter until paid in full, at the Prime Rate plus twenty percent (20%) per annum.
- 11.10 The directors of the Association may, if they reasonably anticipate from time to time that the Shared Costs will exceed the Budgeted Shared Costs, render invoices to the applicable Association Members in the amount of their respective percentage share of such shortfall based on the applicable percentage allocation set forth in section 11.12, describing the items of Shared Costs that are in excess of the Budgeted Shared Costs and the amount of such shortfall in reasonable detail, and the Association Members will pay such invoices to the Association within thirty (30) days of receipt thereof.
- 11.11 Within ninety (90) days following the end of each calendar year, the directors of the Association will make a final determination of the actual Shared Costs for such preceding calendar year and deliver an Annual Shared Costs Statement to each of the

Association Members, showing the particulars of the actual Shared Costs for such year in reasonable detail. If the Annual Shared Costs Statement shows that Shared Costs for the preceding calendar year are due and owing from any of the Association Members, then the applicable Association Members in each case will pay the amounts due and owing by them to the Association within thirty (30) days following receipt of the Annual Shared Costs Statement. If the Annual Shared Costs Statement shows that the Association has over-collected Shared Costs from an Association Member for the preceding calendar year, then the Association will credit such Association Member the amount of such over-collection against future Shared Costs Payments payable by such Association Member.

- 11.12 Each Association Member's percentage allocation of the Shared Costs will be determined using the following formula:

$$\frac{\text{Shared Costs} \times \text{aggregate Calculable Area of all Building(s) on such Association Member's Lot}}{\text{aggregate Calculable Area of all Buildings on all Association Members' Lots}}$$

- 11.13 In determining the Shared Costs payable by the Association Members from time to time, the directors will act reasonably, but with a view to ensure that the payment of the Shared Costs to which the Association Members are obligated to contribute pursuant hereto are paid in full.
- 11.14 Notwithstanding anything contained herein to the contrary, the obligation of an Association Member to pay its percentage allocation of the Shared Costs in respect of its Lot will not commence until an occupancy permit has been issued for all of the Buildings on such Lot (a Lot for which an occupancy permit has been issued for all of the Buildings on such Lot referred to herein as an "**Occupied Lot**"). For example, if there are only two Association Members whose Lots are Occupied Lots during a given period of time, then those two Association Members will, together, be solely responsible for the Shared Costs incurred during such period and such Shared Costs will be allocated between those two Association Members in accordance with the formula set out in section 11.12 (and, for greater certainty, the denominator of the formula set out in section 11.12 will only include the Calculable Area of the Buildings on those two Occupied Lots).
- 11.15 Each Association Member that is a Strata Member will be responsible for collecting from the strata lot owners in its Development, each strata lot owner's share of that Association Member's percentage allocation of the Shared Costs. Such percentage allocation of the Shared Costs will form part of the budget for each Strata Corporation, with the line item relating to the Association Member's share of the Annual Shared Costs Budget to be allocated to individual strata lot owners based on their unit entitlement and included in their monthly assessments. Strata Members must remit the required percentage allocation of the Shared Costs to the Association when such percentage allocation of the Shared Costs is due hereunder, regardless of whether the Strata Member has collected the full amount of such percentage allocation of the Shared Costs from its owners.

- 11.16 The Association may charge interest on the amount of any Shared Costs Payment payable hereunder from the due date of payment thereof until such Shared Costs Payment is paid in full at the following rates: (a) at the Prime Rate plus four percent (4%) per annum for a period of thirty (30) days after the due date; and (b) thereafter until paid in full, at the Prime Rate plus twenty percent (20%) per annum.
- 11.17 The directors of the Association will keep or cause to be kept accurate accounting records of all Shared Costs at a location within the Columbia Shuswap Regional District, which records will be made available at reasonable times for inspection or audits by the applicable Association Members upon thirty (30) days prior written notice and such records will be kept for a period of six (6) years following the end of each calendar year.
- 11.18 While the Association is responsible pursuant to section 8.4 for observing and performing the covenants and obligations of the grantor(s) under the Road and Trail System Public SRW, it is acknowledged that each Association Member may, from time to time, incur costs or expenses in observing and performing its covenants and obligations under the Road and Trail System Public SRW applicable to such Association Member's Lot. If an Association Member incurs any costs or expenses in observing and performing its covenants and obligations under the Road and Trail System Public SRW applicable to such Association Member's Lot, then such Association Member may apply to the Association for reimbursement of all or a portion of such costs and expenses. If the directors of the Association determine, acting reasonably, that such costs and expense are properly and reasonably incurred pursuant to and in accordance with the applicable Road and Trail System Public SRW, then the Association will credit such Association Members for all or part of such costs or expenses (the amount of costs and expenses so credited will be determined by the directors of the Association, acting reasonably, and is referred to herein as the "**Association Member Credited Costs**") against future Shared Costs Payments payable by such Association Member to the Association hereunder, and the amount of any Association Member Credited Costs will form part of the Shared Costs hereunder.

ARTICLE 12 SEAL

- 12.1 The directors may provide a common seal for the Association and may destroy a seal and substitute a new seal in its place.
- 12.2 The common seal must be affixed only when authorized by a resolution of the directors and then only in the presence of the persons specified in the resolution, or if no persons are specified, in the presence of the president and secretary or president and secretary-treasurer.

ARTICLE 13 BORROWING

- 13.1 In order to carry out the purposes of the Association the directors may, on behalf of and in the name of the Association, raise or secure the payment or repayment of money in the manner they decide, and, in particular but without limiting that power, by the issue of debentures, subject to the *Strata Property Act* (BC) in the case of Strata Members.
- 13.2 The Association Members may, by special resolution, restrict the borrowing powers of the directors, but a restriction imposed expires at the next annual general meeting.

- 13.3 Without limiting the Association’s obligations set forth in sections 11.17, the Association will keep proper accounting records in respect to all financial and other transactions, including the following:
 - (a) all money received and disbursed by the Association and the matter in respect of which the receipt and disbursement took place;
 - (b) every asset and liability of the Association; and
 - (c) every other transaction affecting the financial position of the Association.
- 13.4 Documents relating to the assets and liability of the Association, including the accounting records, will be open to the inspection of any director on reasonable notice to the Association and such records will be kept for a period of six (6) years following the end of each calendar year.

**ARTICLE 14
AUDITOR**

- 14.1 This Article 14 applies only if the Association is required or has resolved to have an auditor.
- 14.2 The first auditor must be appointed by the directors who must also fill all vacancies occurring in the office of auditor. If appointed, the auditor will make an annual report to the Association Members on the financial statements that are to be placed before the Association at the next annual general meeting. The auditor will state in the report whether, in the auditor's opinion, the financial statements presents fairly the financial position of the Association and the results of its operations for the period under review and, will identify expenditures or commitments which appear to be inconsistent with the purposes of the Association or significant changes from prior annual reports. If the opinion contained in the report of the auditor is qualified, the auditor will state the reasons in the report.
- 14.3 At each annual general meeting the Association must appoint an auditor to hold office until the auditor is re-elected or a successor is elected at the next annual general meeting.
- 14.4 An auditor may be removed by ordinary resolution.
- 14.5 An auditor must be promptly informed in writing of the auditor’s appointment or removal.
- 14.6 A director or employee of the Association must not be its auditor.
- 14.7 The auditor may attend general meetings.

**ARTICLE 15
NOTICES**

- 15.1 A notice may be given under these Bylaws, either personally or by mail, delivery or e-mail to the recipient at the recipient’s address or e-mail address provided that any party may change its address or e-mail address by written notice to the other and in such event this section 15.1 will be deemed to be amended accordingly.

- 15.2 A notice sent by mail is deemed to have been given on the third day following the day on which the notice is posted, provided that if mailed should there be, between mailing and the actual receipt of such notice, a mail strike, slowdown or other labour dispute which might affect the delivery of such notice, such notice will only be effective if actually delivered or e-mailed. A notice sent by delivery or e-mail will be conclusively deemed to have been given or made on the day it is actually delivered or e-mailed unless it is delivered or e-mailed after 5:00 p.m. (Vancouver time) or on a day other than a business day, in which case it will be deemed to have been given or made on the next business day.

- 15.3 (a) Notice of a general meeting must be given to:
 - (i) every Association Member shown on the register of members on the day notice is given; and
 - (ii) the auditor, if Article 14 applies.(b) No other person is entitled to receive a notice of a general meeting.

**ARTICLE 16
VIOLATION OF BYLAWS**

- 16.1 Any infraction of violation of these Bylaws or of any Community Rule by any Association Member (or, in respect of a Strata Member, by an owner of a strata lot in its Development or such owner's tenant or occupant, or the respective invitees, guests or visitors of any of the foregoing) may be corrected, remedied or cured by the Association, and any costs or expenses expended or incurred by the Association in correcting, remedying or curing such infraction or violation will be charged to that Association Member and will be added to, and become a part of, the next Shared Cost Payment of such Association Member.

- 16.2 In addition to any remedies available at law or in equity, the Association may recover from an Association Member by an action for debt in any court of competent jurisdiction:
 - (a) any Shared Cost Payment that any Association Member is required to pay to the Association hereunder and fails to pay when due; or
 - (b) any sum of money which the Association is required to expend as a result of any act or omission, or any infraction or violation of these Bylaws or any Community Rule, by the Association Member (or, in respect of a Strata Member, by an owner of a strata lot in its Development or such owner's tenant or occupant, or the respective invitees, guests or visitors of any of the foregoing).

**ARTICLE 17
BYLAWS**

- 17.1 These Bylaws must not be altered or added to except by special resolution.

- 17.2 Each Association Member, on being admitted, is entitled to a copy of the constitution and bylaws of the Association, without charge.

SCHEDULE A
THE LANDS

The following lands and premises located in Revelstoke, British Columbia

1. the lands formerly legally described as Lot 1, Section 23, Township 23, Range 2, West Of The 6th Meridian, Kootenay District, Plan EPP69441 (now stratified by Strata Plan EPS4700) (the “**EPS4700 Lands**”);
2. Parcel Identifier: 031-465-421, Lot A Section 23 Township 23 Range 2 West of the 6th Meridian Kootenay District Plan EPP98511 (the “**Lot A**”); and
3. Parcel Identifier: 030-260-833, Lot 2 Section 23 Township 23 Range 2 West of the 6th Meridian Kootenay District Plan EPP69441, except part in Plan EPP98511 (**Lot 2**).